



**Surgical
Instruments**

Percussion Hammers & Aesthesiometers



01-101
TROEMNER
Size: 245 mm

1/2



01-102
DEJERINE
Size: 200 mm

1/2

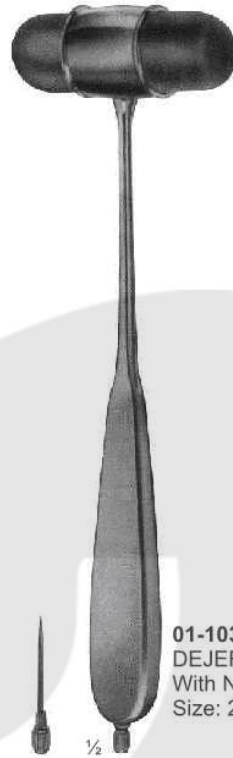

01-103
DEJERINE
With Needle
Size: 210 mm

1/2

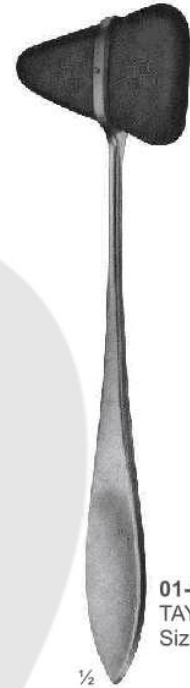

01-104
TAYLOR
Size: 195 mm

1/2



1/2



01-105
BERLINER
Size: 200 mm

1/2

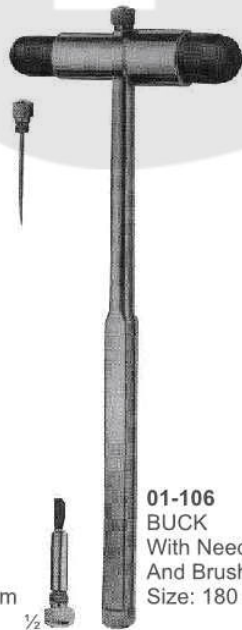

01-106
BUCK
With Needle
And Brush
Size: 180 mm

1/2



01-107
RABINER
With Needle
And Brush
Size: 255 mm

1/2



01-108
ALY
Size: 190 mm

1/2



01-109
WARTENBERG
Pinwheel For
Neurological
Examination
Size: 185 mm

1/2

Stethoscopes



01-110
PINARD (Aluminum)
Size: 155 mm

1/2



01-111
aus Holz (Wooden)
Size: 145 mm

1/2

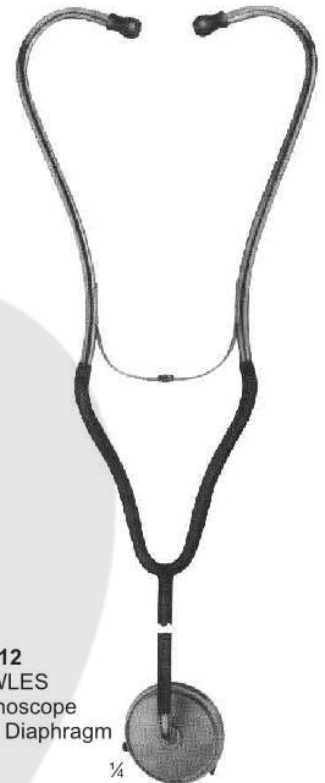

01-112
BOWLES
Stethoscope
With Diaphragm

1/4



01-113
ANESTOPHON

1/3

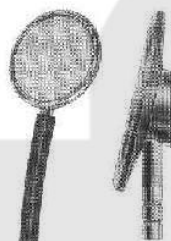

01-114
FORD-BOWLES
Duel Chest Piece
With Two Outlets

1/4



01-115
BOWLES

1/4

Head Mirrors & Head Bands



01-116
ZIEGLER Ø mm
Head mirror only
with rubber coating

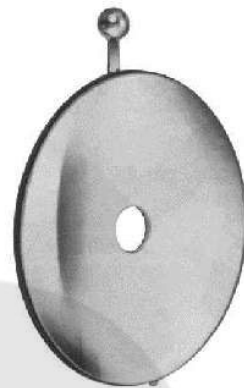

01-117
ZIEGLER Ø mm
Head mirror only
with metal coating



01-118
ZIEGLER
Head band of plastic black

01-119
ZIEGLER
Head band of plastic white

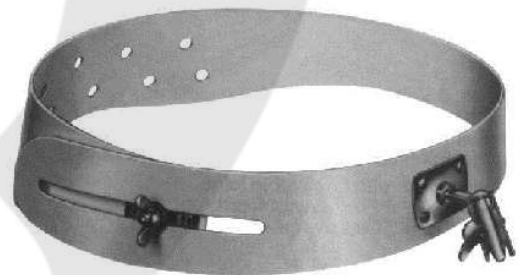

01-120
MURPHY
Head band of celluloid, white

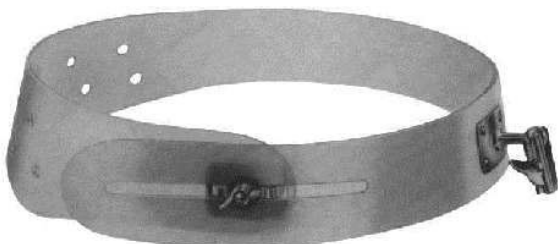

01-121
Head band of plastic,
white, soft pattern



01-122
Head mirror with black
plastic head band.

Head Light

01-123

CLAR

Head light, 6 volt, with adjustable joint,
white celluloid head band,
cord with plugs for transformer

01-124

White celluloid head band, only, for

01-125

Spare mirror only, for

01-127

CLAR

Head light, 6 volt, with adjustable joint,
white celluloid head band, with foam rubber pad
and cord with plugs for transformer

01-128

White celluloid head band, only, for head light

01-129

mirror only, for head light

spare foam rubber pad, for head band

01-131

CLAR

Head light, 6 volt, with adjustable joint,
white plastic head band,
cord with plugs for transformer

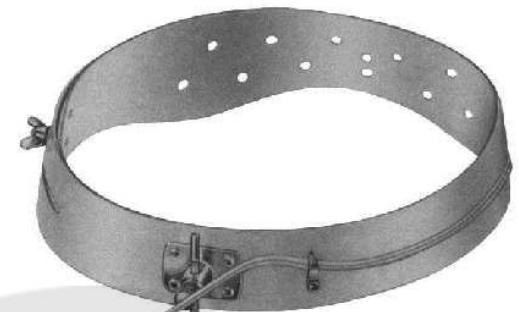

01-126
spare bulb

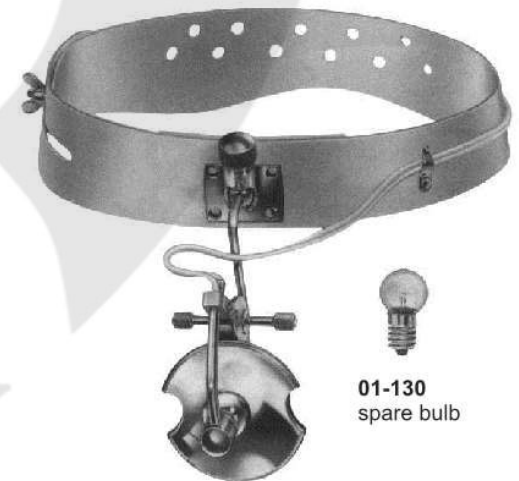

01-130
spare bulb



01-132
spare bulb

Tongue Depressors

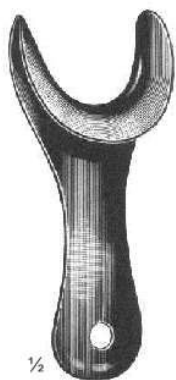
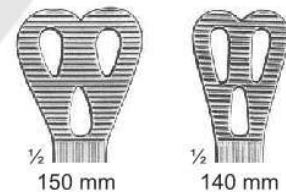
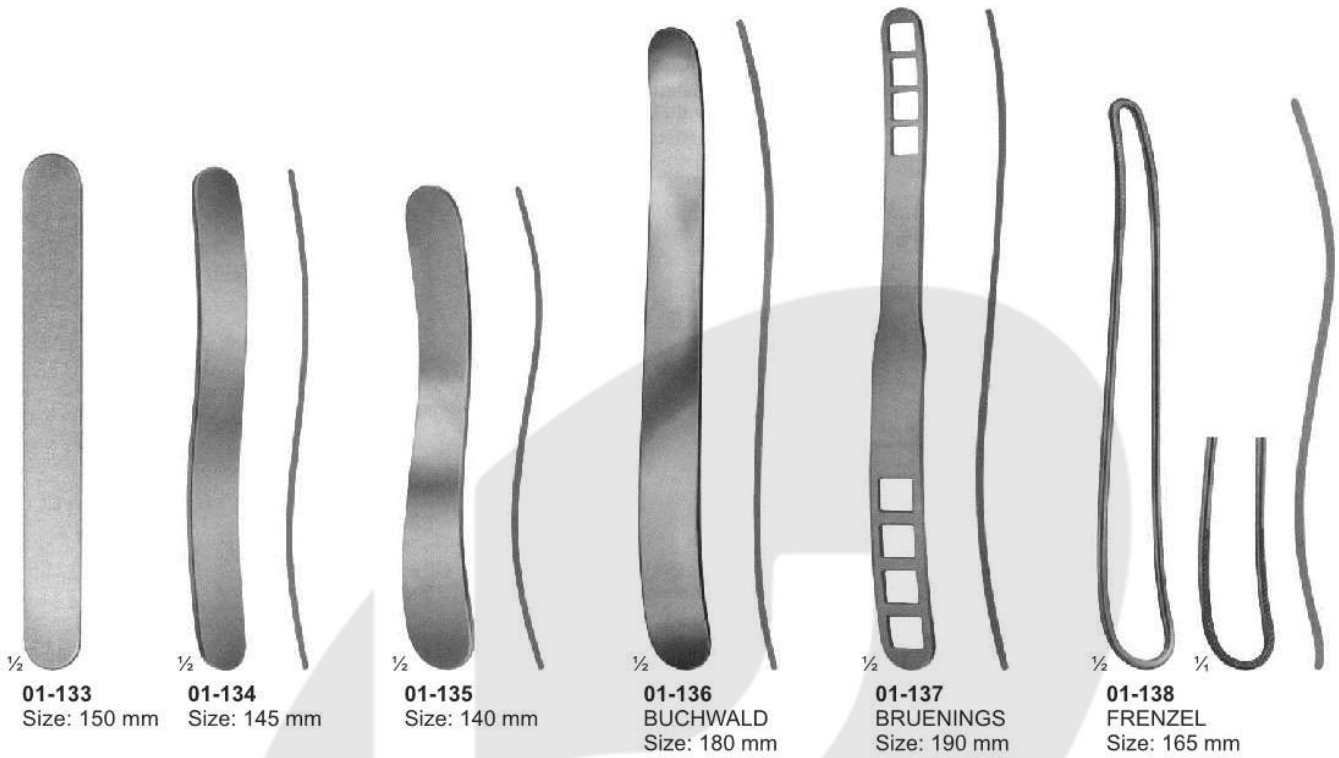

01-139
 SIMPLEX
 Size: 110 mm



01-140
 STEMBERG
 Size: 120 mm, 140 mm, 160 mm



01-141
 TOBOLD
 Size: 145 mm

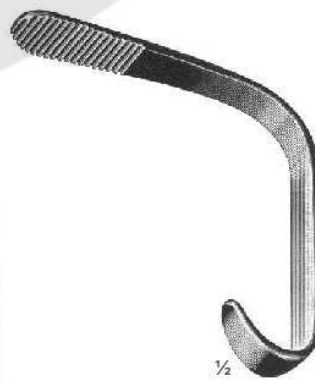

01-142
 ANDREW
 Size: 110 mm

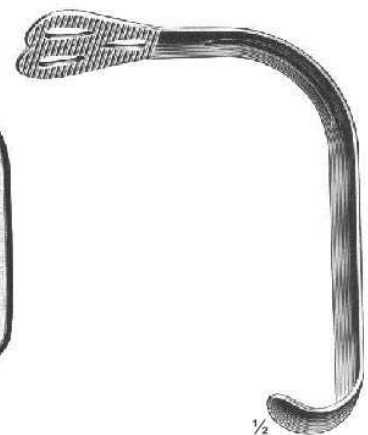

01-143
 WIEDER

Tongue Depressors



1/2
01-144
SCHIMMELBUSCH
 Ether Mask



1/2
01-145
HEISTER
 Mouth Gag
 Size: 130 mm



1/2
01-146
FERGUSSON-ACKLAND
 Mouth Gag
 Size: 145 mm



1/2
01-147
DENHARDT
 Mouth Gag With Silicon
 Inserts, Interchangeable
 Size: 125 mm



1/2
01-148
ROSER KONIG
 Mouth Gag
 Size: 160 mm, 185 mm



1/4
 1 Pair Of
 Rubber Pads



1/4
 Size: 160 mm



1/4
 Size: 170 mm



1/4

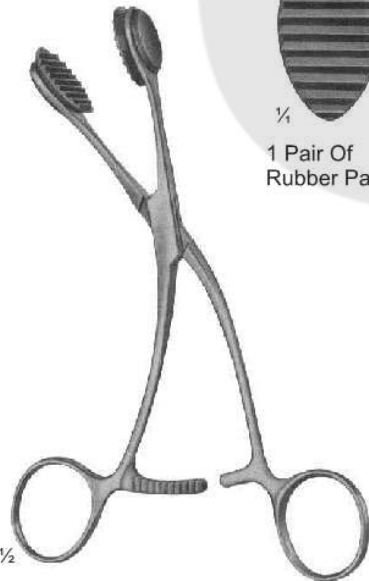

1/2
01-149
YOUNG
 Size: 165 mm

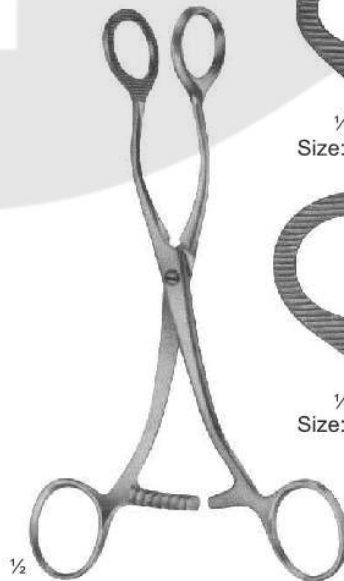

1/2
01-150
COLLIN
 Size: 160 mm, 170 mm

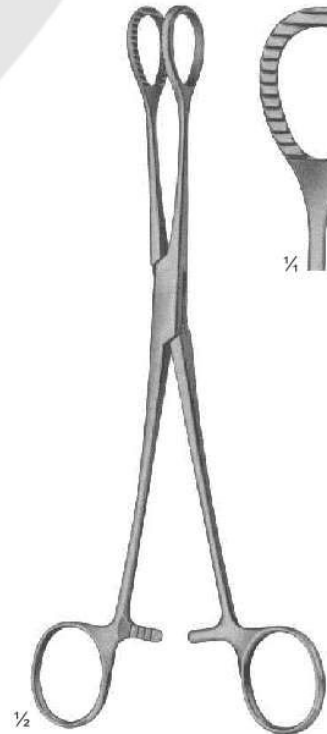

1/2
01-151
HEYWOOD-SMITH modif.
 Size: 215 mm

Blood Lancets & Laryngeal Mirrors

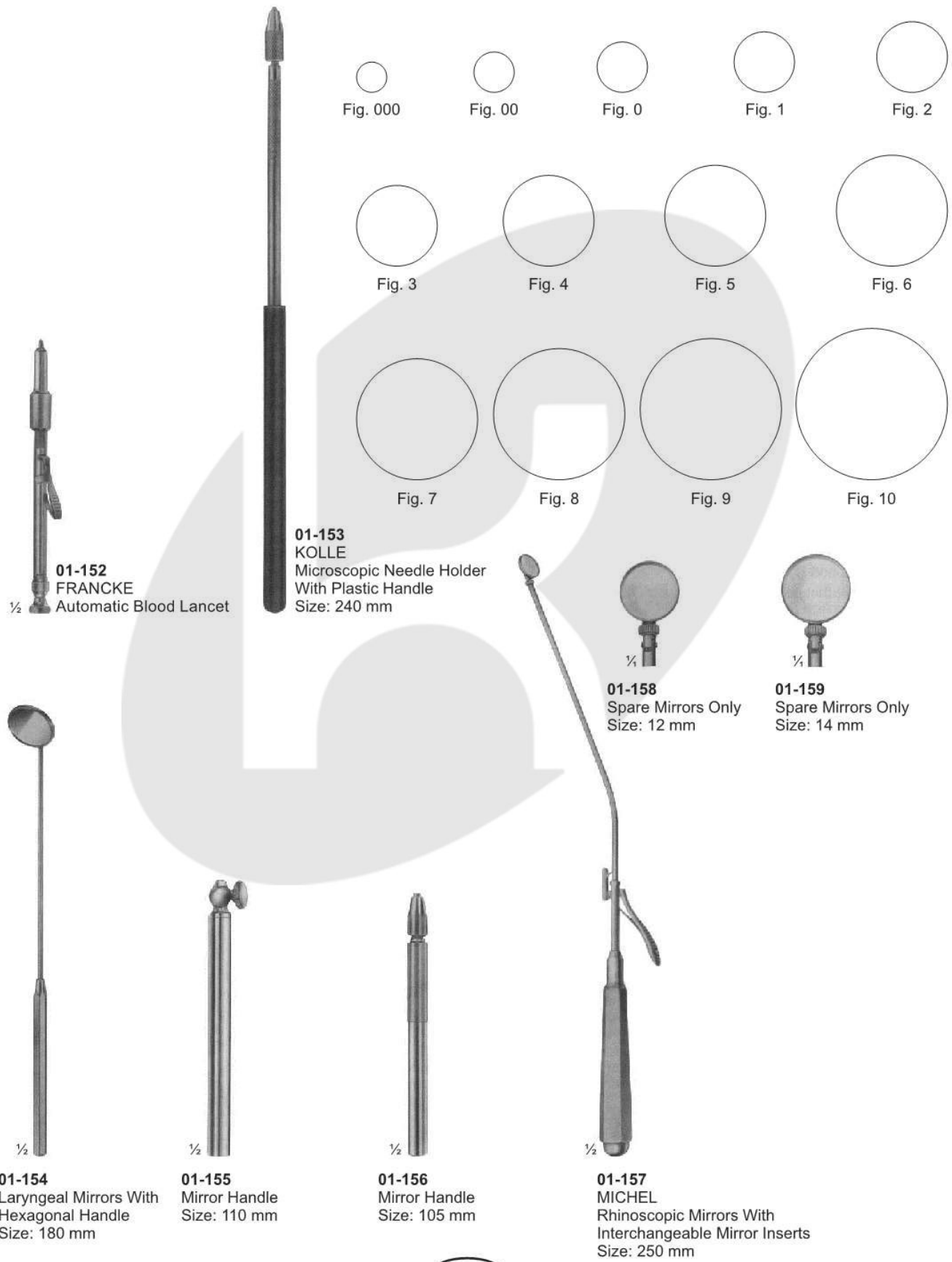

01-152
FRANCKE
Automatic Blood Lancet

01-153
KOLLE
Microscopic Needle Holder
With Plastic Handle
Size: 240 mm

01-158
Spare Mirrors Only
Size: 12 mm

01-159
Spare Mirrors Only
Size: 14 mm

01-154
Laryngeal Mirrors With
Hexagonal Handle
Size: 180 mm

01-155
Mirror Handle
Size: 110 mm

01-156
Mirror Handle
Size: 105 mm

01-157
MICHEL
Rhinoscopic Mirrors With
Interchangeable Mirror Inserts
Size: 250 mm

Diagnostic Sets



1/2

01-160 - 162
MAGILL



1/4

01-160
Infants
Size: 150 mm



1/4

01-161
Children
Size: 200 mm



1/4

01-162
Adults
Size: 250 mm



1/2

01-163
Medium battery handle
only, 25 mm diam.



01-163-A
Spare bulb
2.7 volt, for
autosopes



01-163-B
Spare bulb
2.6 volt, for
ophthalmoscopes



01-164
Otoscope Set, Consists Of
Battery Handle Without Batteries,
3 Ear Specula, 1 Bulb In Velvet Lined Case



01-165
Diagnostic Set, Otoscope With Three Specula,
Nasal Speculam, Lamp Holder, Two Laryngeal
Mirrors, Tongue Blade Holder

Diagnostic Sets

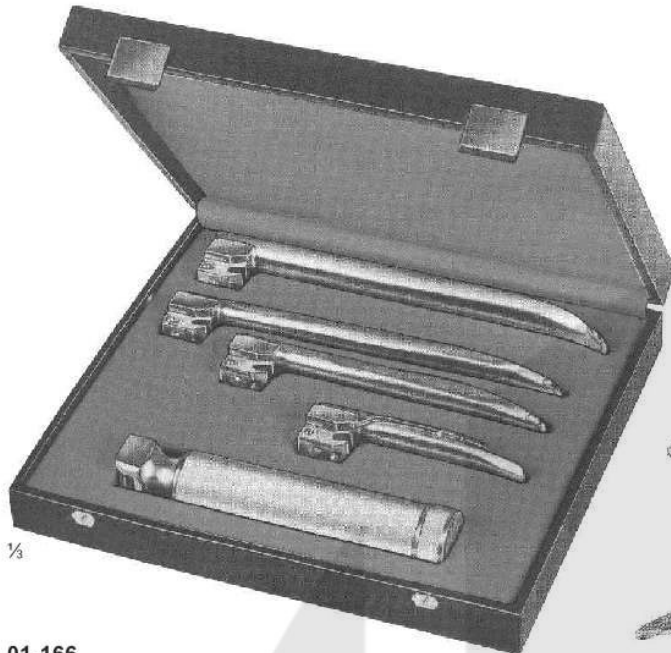

1/3

01-166
MILLER
 Laryngoscope Set, Consists Of Battery Handle (Without Battery)
 With Four Miller Laryngoscope Blades

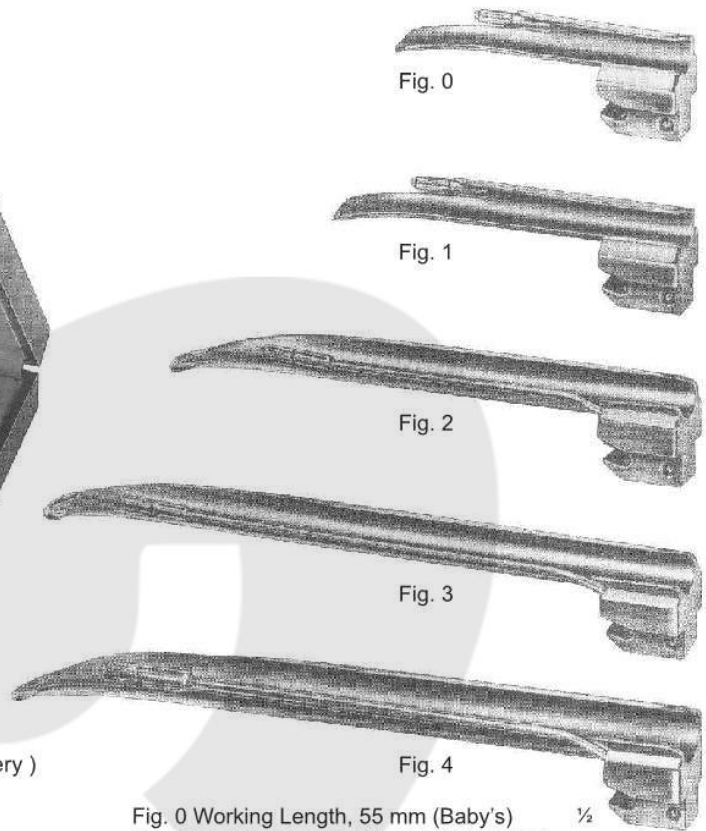

Fig. 0 Working Length, 55 mm (Baby's) 1/2
 Fig. 1 Working Length, 80 mm (Children's)
 Fig. 2 Working Length, 130 mm (Adolescent's)
 Fig. 3 Working Length, 170 mm (Women's)
 Fig. 4 Working Length, 180 mm (Men's)



1/3

01-167
GUEDEL-NEGUS
 Laryngoscope Set, Consists Of Battery Handle (Without Battery)
 With Four Miller Laryngoscope Blades

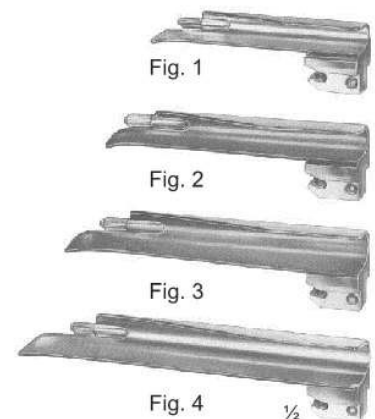

Fig. 1 Working Length, 70 mm (Children's)
 Fig. 2 Working Length, 90 mm (Adolescent's)
 Fig. 3 Working Length, 110 mm (Women's)
 Fig. 4 Working Length, 135 mm (Men's) 1/2

Diagnostic Sets



1/3

01-168
 McIntosh
 Laryngoscope Set, Consists Of Battery Handle (Without Battery)
 With Three McIntosh Blades, Fig. 1, Fig. 2, Fig. 3

01-169
 McIntosh
 Laryngoscope Set, Consists Of Battery Handle (Without Battery)
 With Five McIntosh Blades, Fig. 1, Fig. 2, Fig. 3, Fig. 4, Fig. 5

Fig. 0

Fig. 1

Fig. 2

Fig. 3

Fig. 4

1/2

Fig. 0 Working Length, 55 mm (Baby's)
 Fig. 1 Working Length, 75 mm (Children's)
 Fig. 2 Working Length, 90 mm (Adolescent's)
 Fig. 3 Working Length, 110 mm (Women's)
 Fig. 4 Working Length, 135 mm (Men's)

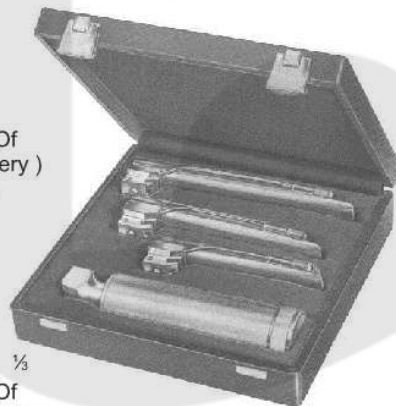

1/3

01-170
 FOREGGER
 Laryngoscope Set, Consists Of
 Battery Handle (Without Battery)
 With Three Foregger Blades,
 Fig. 1, Fig. 2, Fig. 3,

01-171
 FOREGGER
 Laryngoscope Set, Consists Of
 Battery Handle (Without Battery)
 With Five Foregger Blades,
 Fig. 1, Fig. 2, Fig. 3, Fig. 4, Fig. 5

Fig. 1

Fig. 2

Fig. 3

Fig. 4

1/2

Fig. 1 Working Length, 70 mm (Children's)
 Fig. 2 Working Length, 90 mm (Adolescent's)
 Fig. 3 Working Length, 110 mm (Women's)
 Fig. 4 Working Length, 135 mm (Men's)



1/2

01-172
 Fiber Optic
 Battery Handle



1/2

01-173
 Fiber Optic
 Battery Handle



1/4

01-174
 Replacement Lamp
 (Krypton) 2.5 V



1/4

01-175
 Replacement Lamp
 (Halogen) 2.5 V

Examination & Measuring Instruments

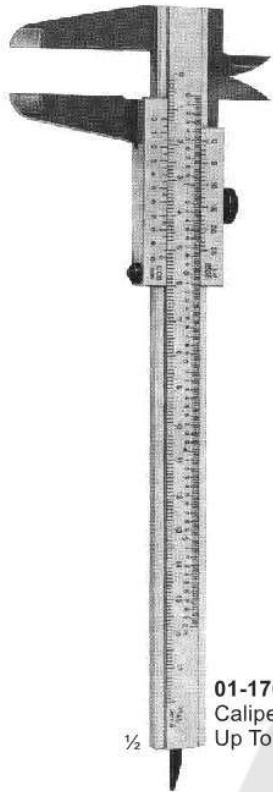

01-176
Caliper Of Aluminum
Up To 180 mm

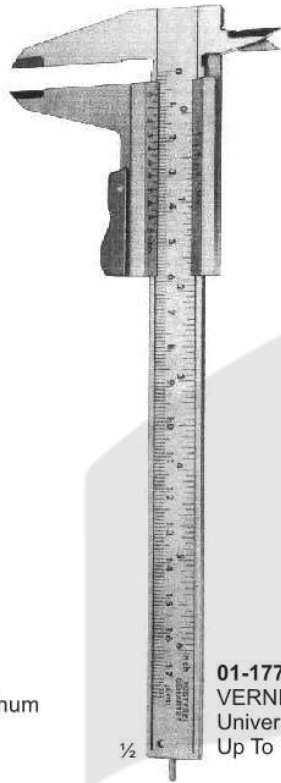

01-177
VERNIER
Universal Caliper Of Steel
Up To 120 mm



01-178
CAROLL
Size: 140 mm



01-179
TOWNLEY
Size: 100 mm

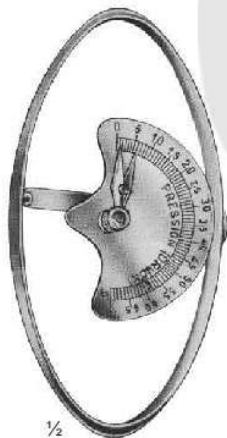

01-180
COLLIN
Druck Pressure 72 kg
Size: 125 mm

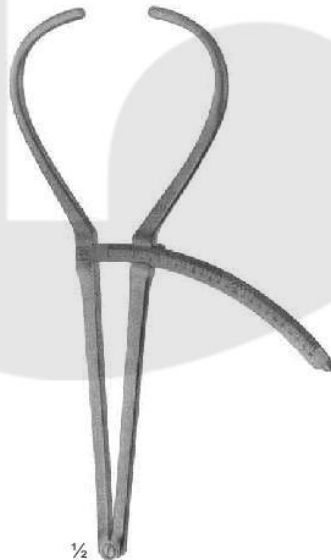

01-181
BERTILLON
Caliper For Measuring The Head
Size: 320 mm

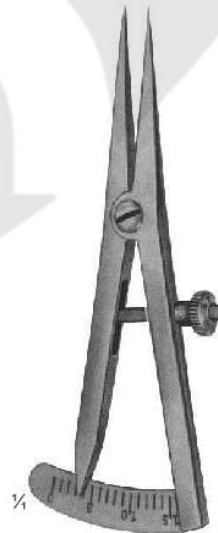

01-182
CASTROVIEJO
Caliper

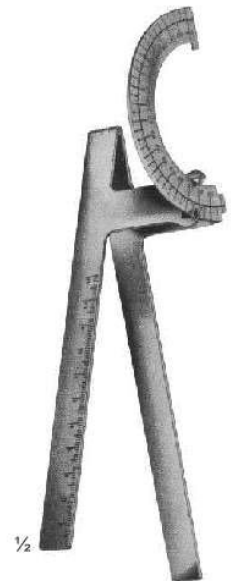

01-183
MOLTGEN
Goniometer



01-185
Size: 150 mm



01-184
Size: 500 mm

Dissecting Knives



02-101 - 110
Fig. 1 - 10



02-101
Fig. 1



02-102
Fig. 2



02-103
Fig. 3



02-104
Fig. 4



02-105
Fig. 5



02-106
Fig. 6



02-107
Fig. 7



02-108
Fig. 8



02-109
Fig. 9



02-110
Fig. 10

Autopsy & Cartilage Knives

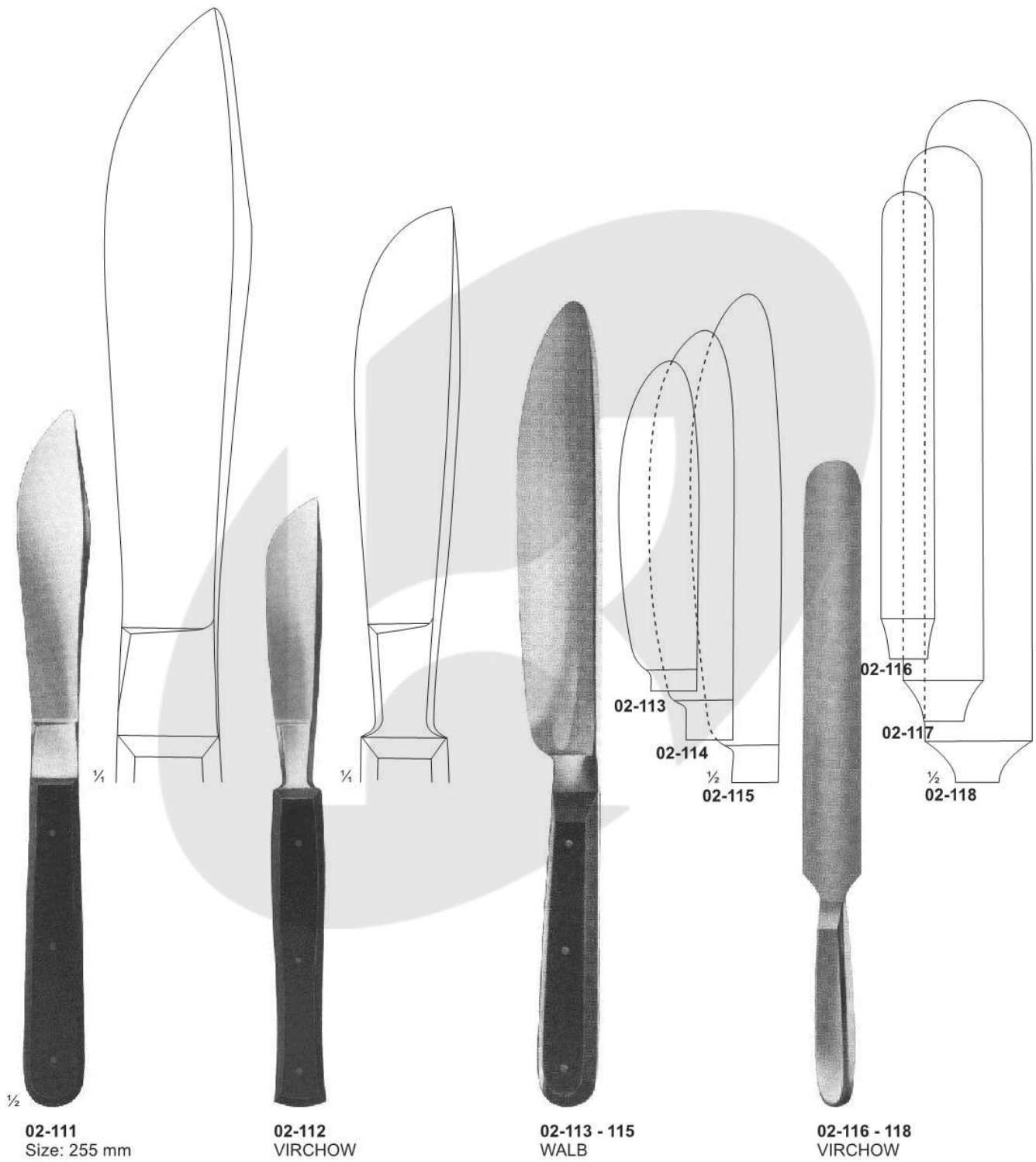

Scalpels, Tenotomes & Resection Knives

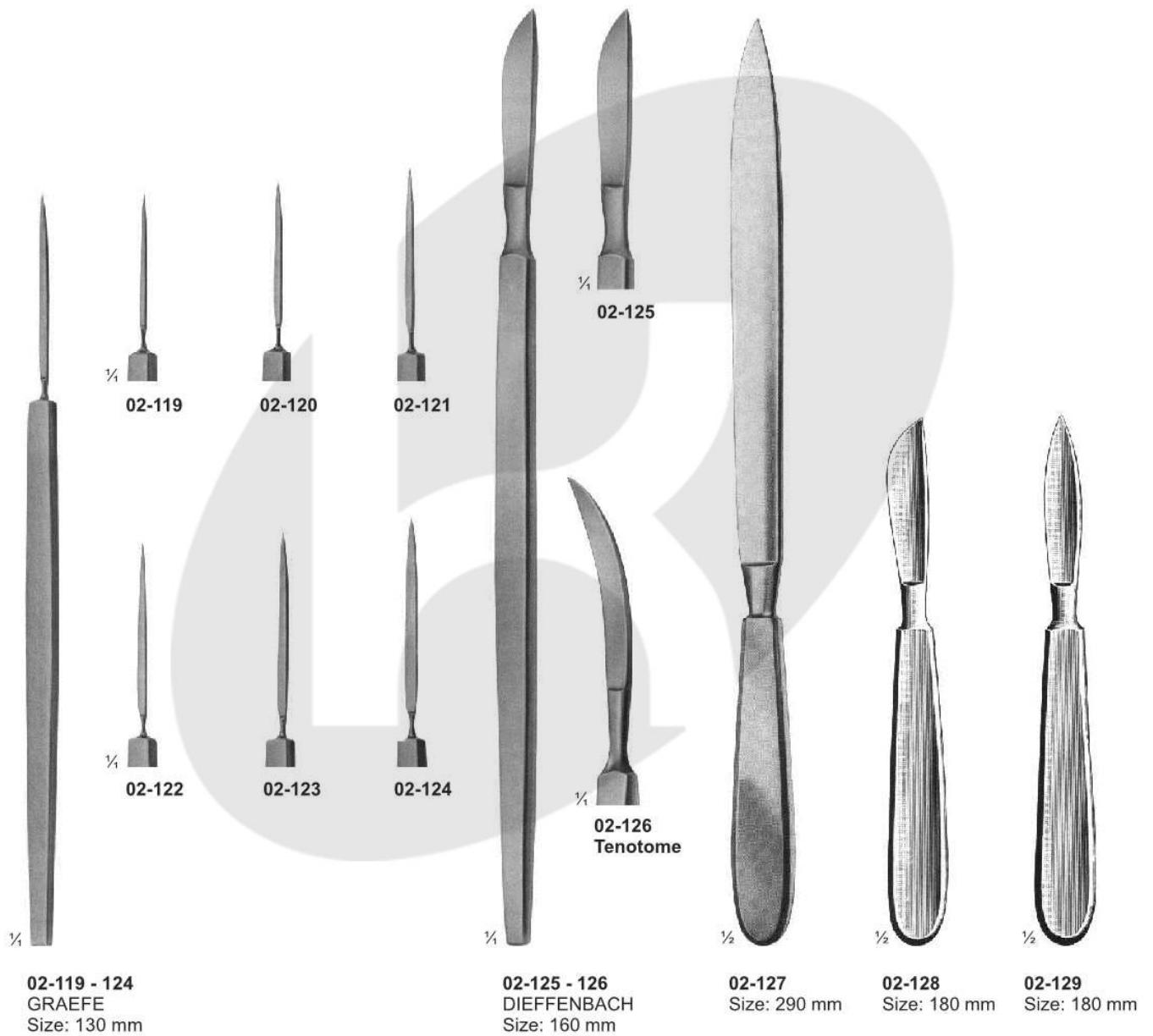

Scalpels, Tenotomes



Amputating Knives, Cartilage Knives, Autopsy Knives

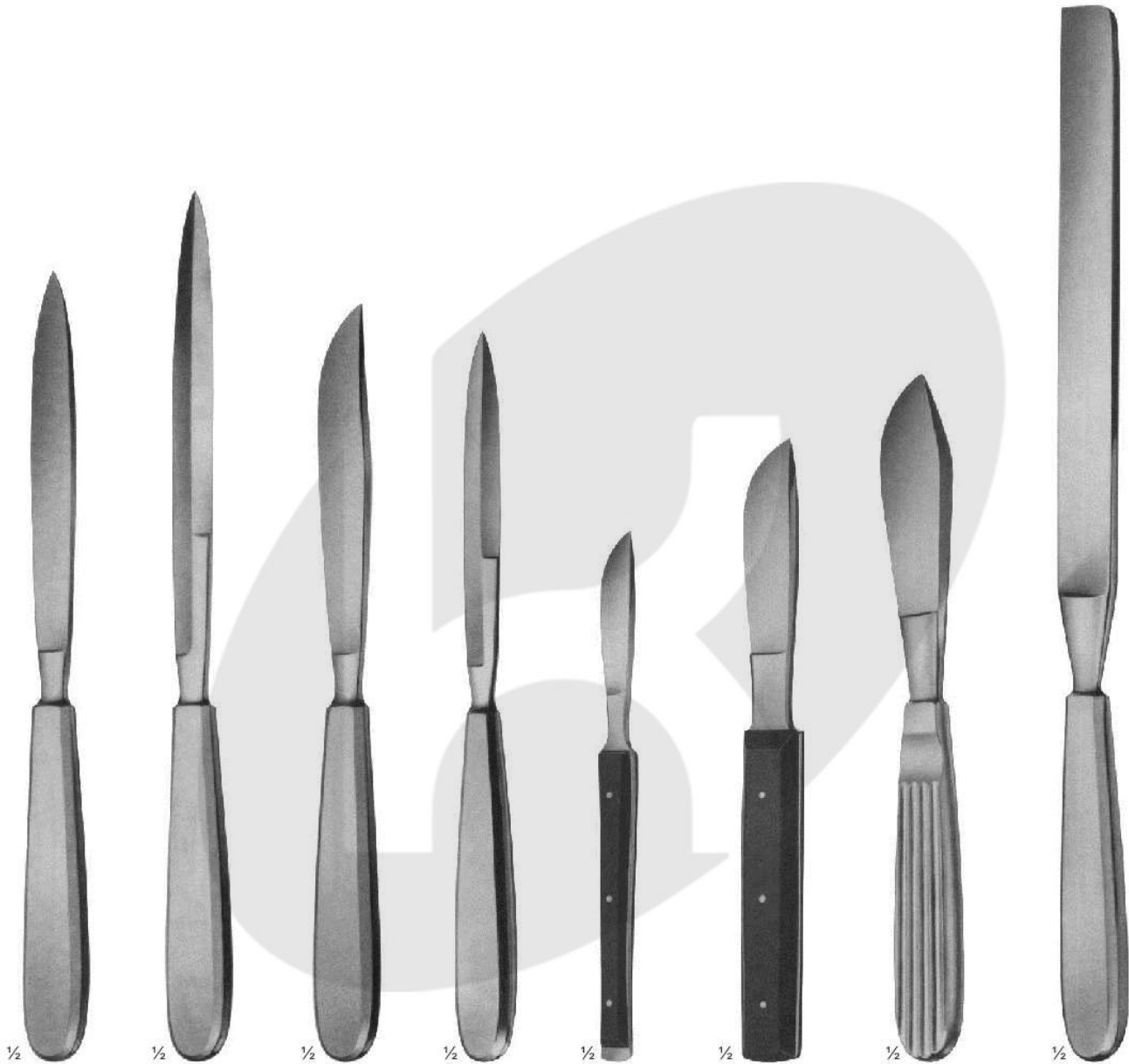

02-150

Size: 130 mm

02-151

Size: 160 mm

02-152

Size: 190 mm

02-153

Size: 200 mm

Blade Length

Amputating Knives

02-154

CATLIN

Size: 160 mm

Blade Length

Amputating

Knives

02-155

LANGENBECK

Size: 120 mm

Blade Length

Flap Knives

02-156

Size: 110 mm

Blade Length

Interosseous

Knives

02-157

Size: 55 mm

Blade Length

With Raspatory,

Wooden Handle

02-158

Size: 70 mm

Blade Length

Wooden Handle

02-159

Size: 80 mm

Blade Length

Metal Handle

02-160

Size: 195 mm

Blade Length

Metal Handle

Cone Knives, Myomatome, Trigeminal & Tonsil Knives

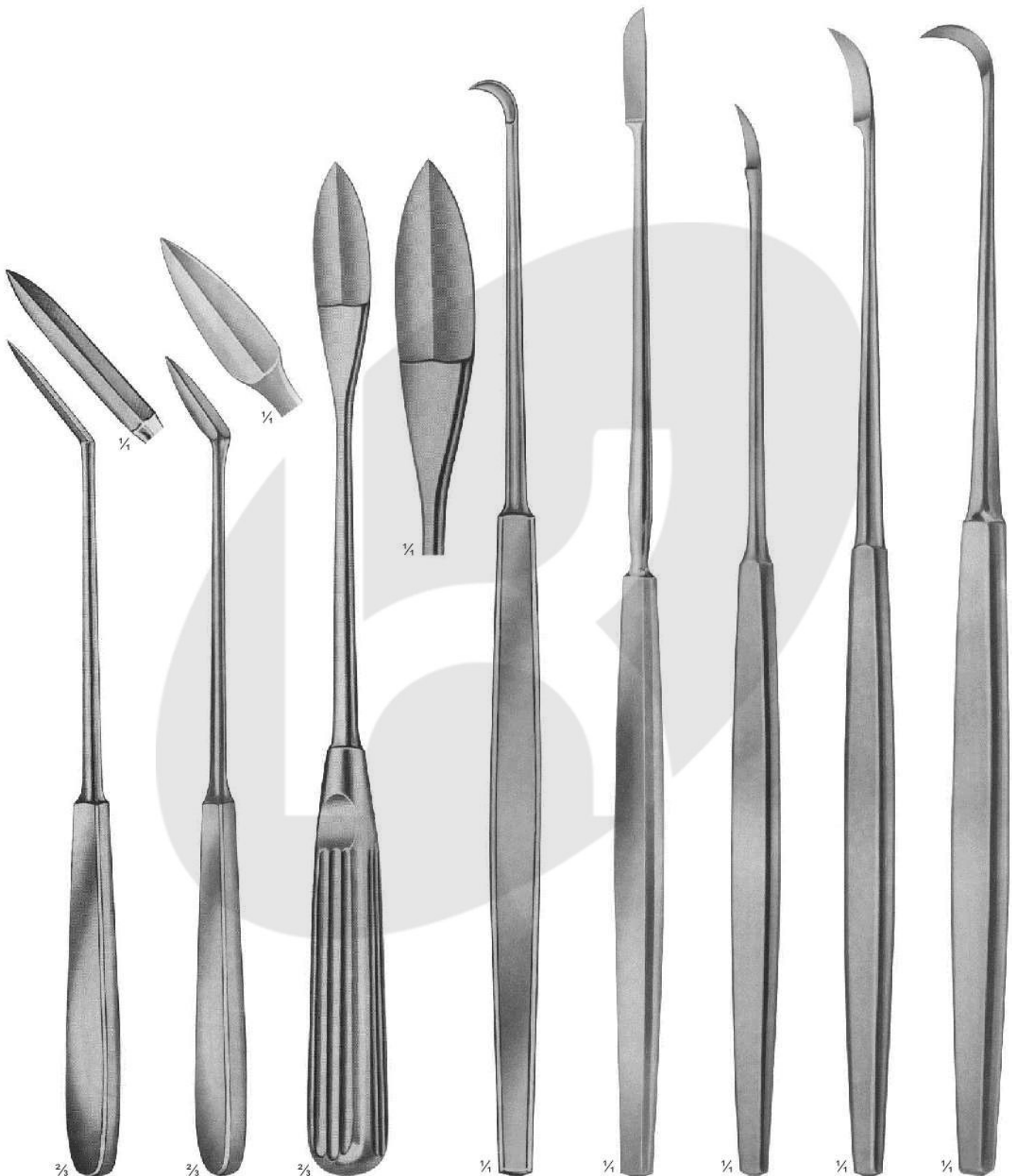

02-161
AYRE
 Size: 235 mm
 Cone Knife

02-162
 Size: 230 mm
 Cone Knife

02-163
SEGOND
 Size: 270 mm
 Myomatome

02-164
OLIVECRONA
 Size: 205 mm
 Trigeminal
 Knife

02-165
 Size: 230 mm
 Trigeminal
 Knife

02-166
FOWLER
 Size: 200 mm
 Tonsil Knife

02-167
ABRAHAM
 Size: 215 mm
 Tonsil Knife

02-168
BRUNINGS
 Size: 215 mm
 Tonsil Knife

Scalpels, Dura Knives & Comedone Extractors

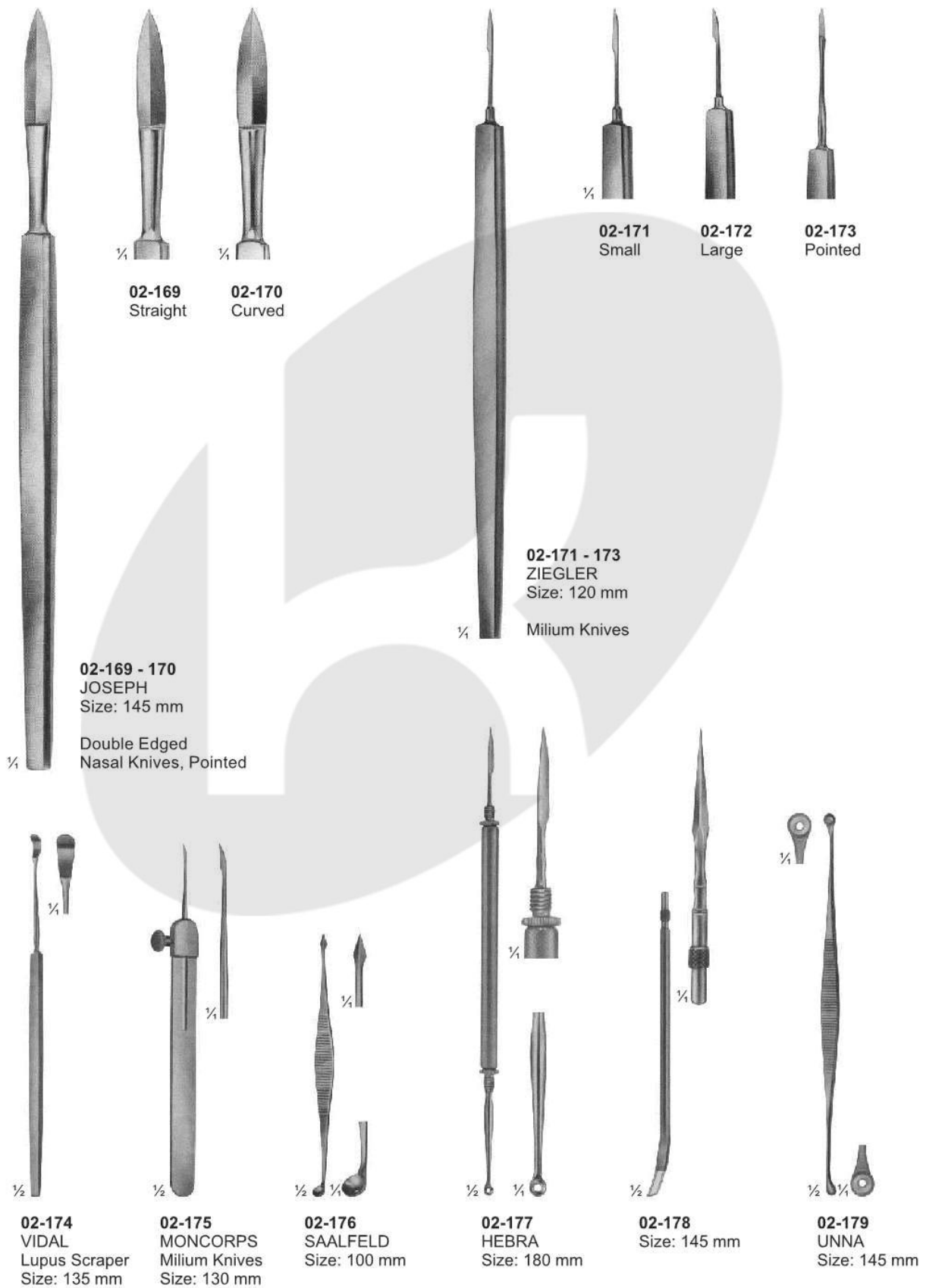

Razor Blade Holders & Breakers



02-180
TROUTMAN-CHRIS
Size: 100 mm

02-181
TROUTMAN-CHRIS
Size: 100 mm

02-182
Size: 110 mm

02-183
CASTROVIEJO
Size: 130 mm

02-184
Size: 185 mm

Scalpel Handles

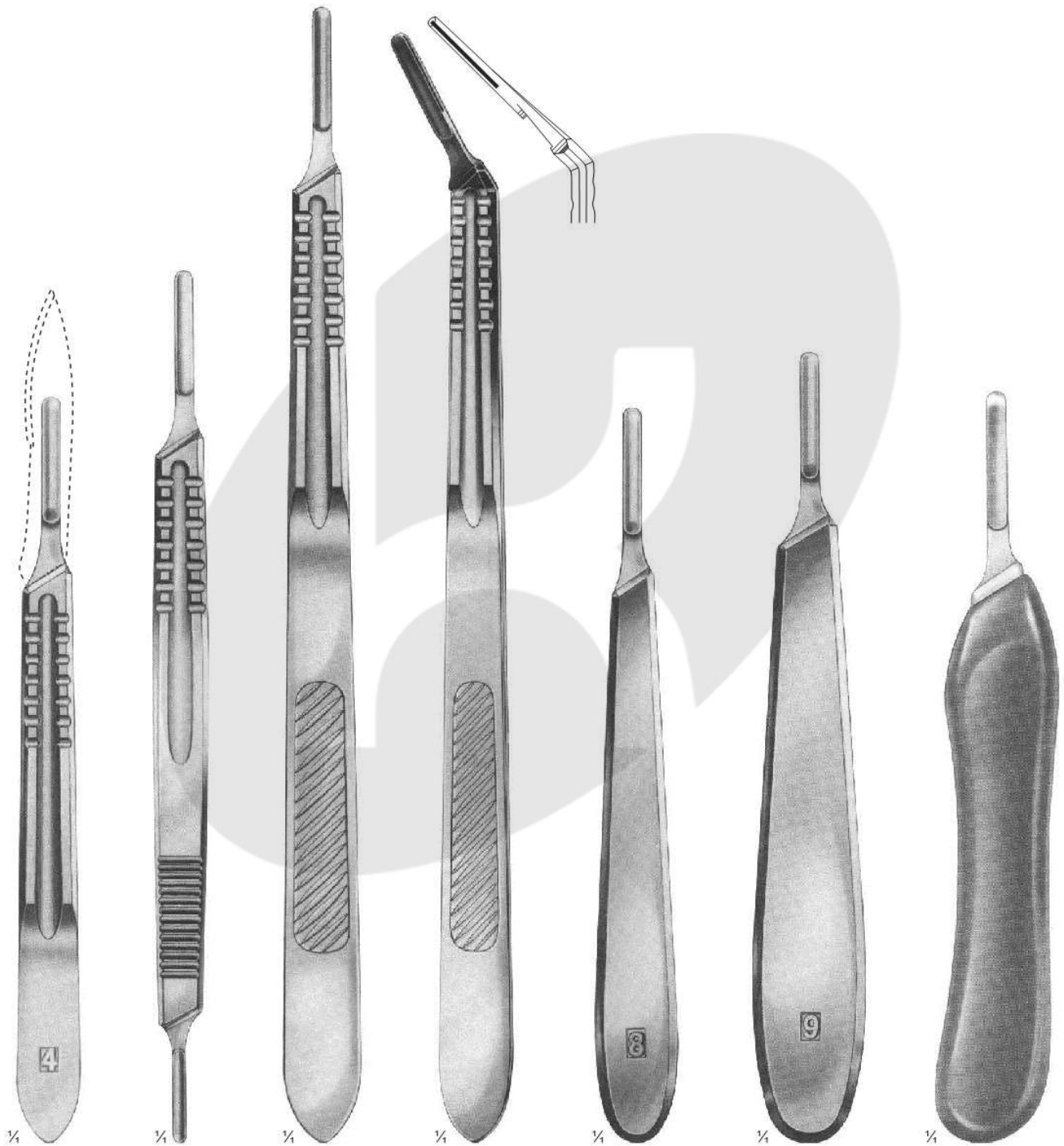

02-185
STANDARD
No. 4
Solid

02-186
Double Handel
No. 4 + No. 3
Solid

02-187
No. 4 L
Straight
Solid

02-188
No. 4 L
Solid Angled

02-189
COLLIN
No. 8
Hollow

02-190
COLLIN
No. 9
Hollow

02-191
Plastic

Scalpel Handles



02-192
STANDARD
No. 3
Solid

02-193
No. 3
Solid

02-194
No. 3
Solid

02-195
No. 3 L
Straight
Solid

02-196
No. 3 L
Angled
Solid

02-197
No. 7
Solid

02-198
No. 7 K
Solid

02-199
Hollow-Round

02-200
No. 3
Straight
Solid

02-201
No. 3
Angled
Solid

Micro Scissors, "Spring Type" Flat Handles

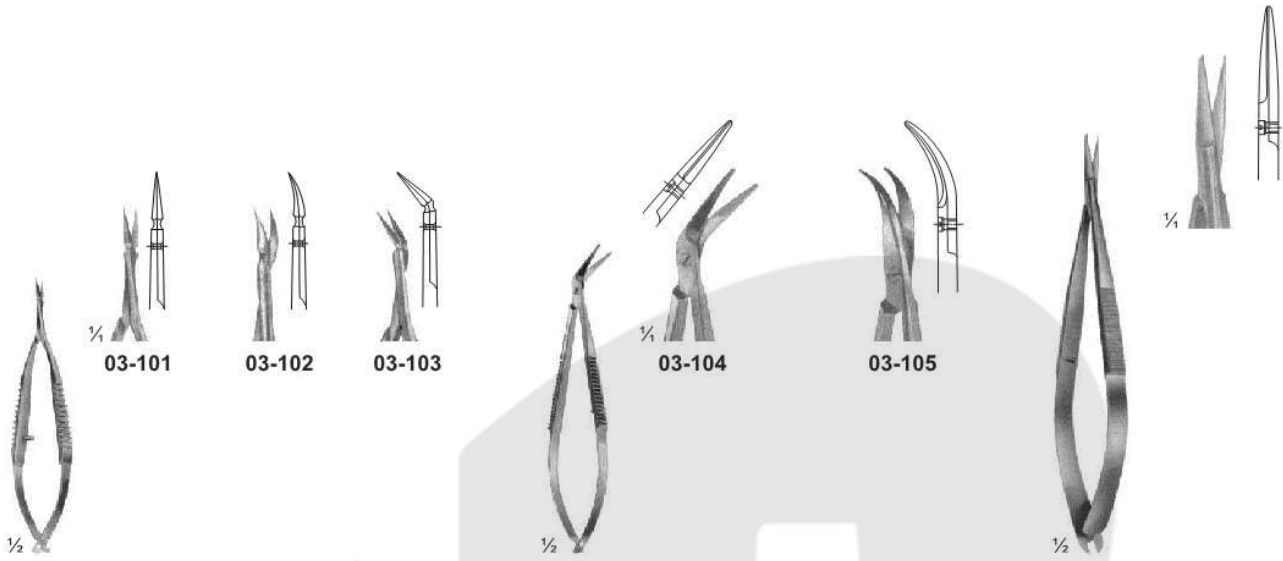

03-101 - 103
VANNAS
Size: 85 mm

03-104 - 105
CASTROVIEJO
Size: 95 mm

03-106
NOYES
Size: 125 mm

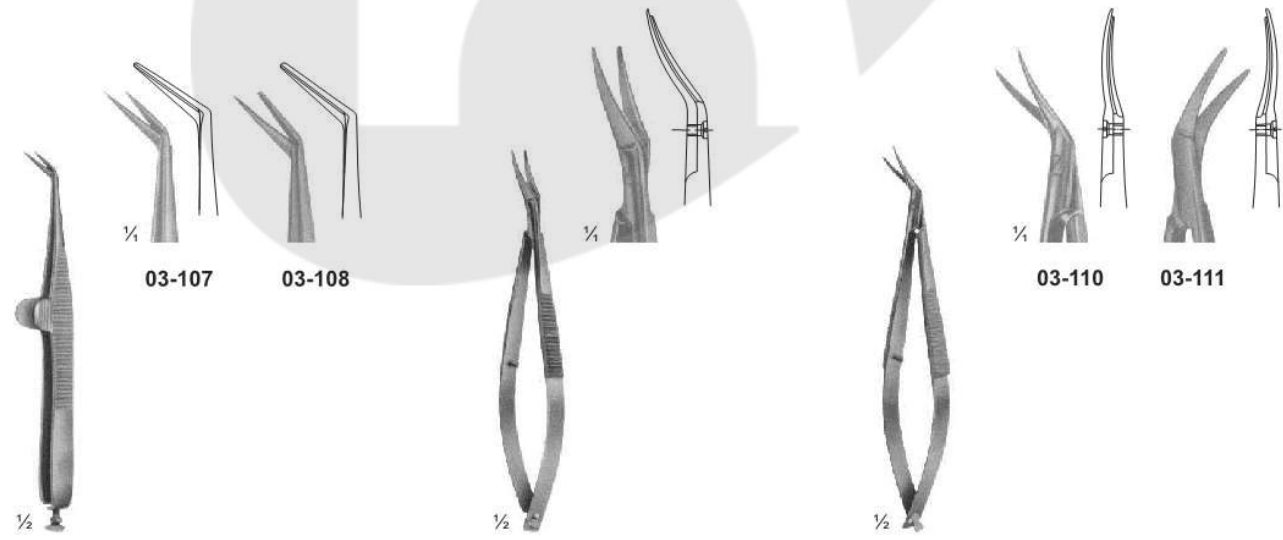

03-107 - 108
WECKER
Eye Scissor
Size: 110 mm

03-109
CASTROVIEJO
Eye Scissor
Size: 115 mm

03-110 - 111
CASTROVIEJO
Eye Scissor
Size: 110 mm

Micro Scissors, "Spring Type" Flat Handles

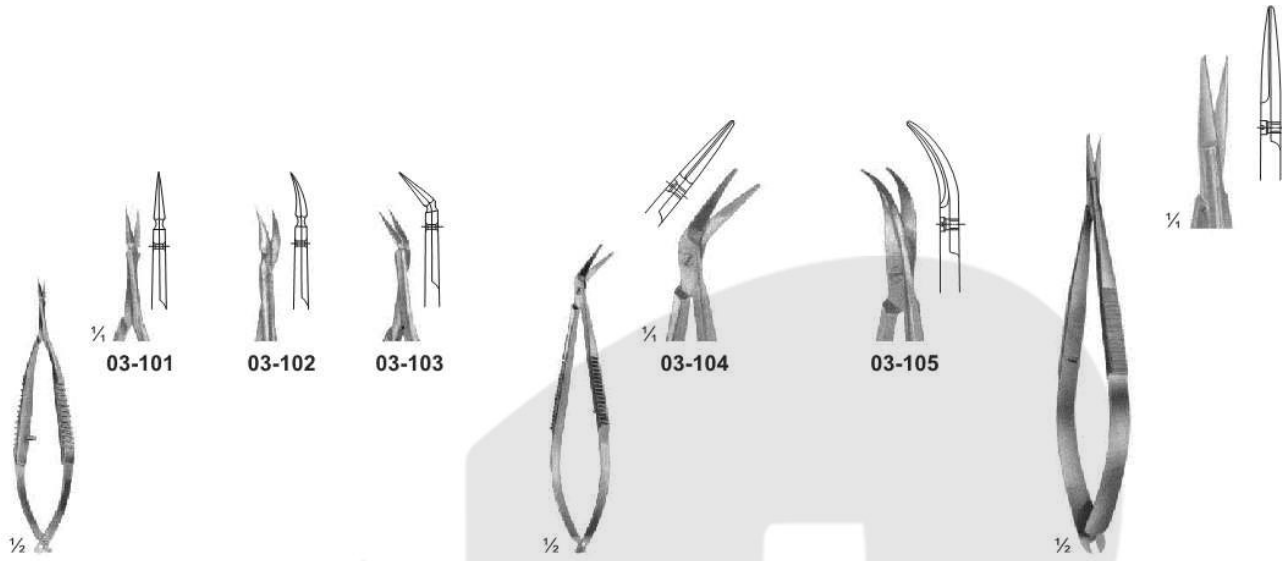

03-101 - 103
VANNAS
Size: 85 mm

03-104 - 105
CASTROVIEJO
Size: 95 mm

03-106
NOYES
Size: 125 mm

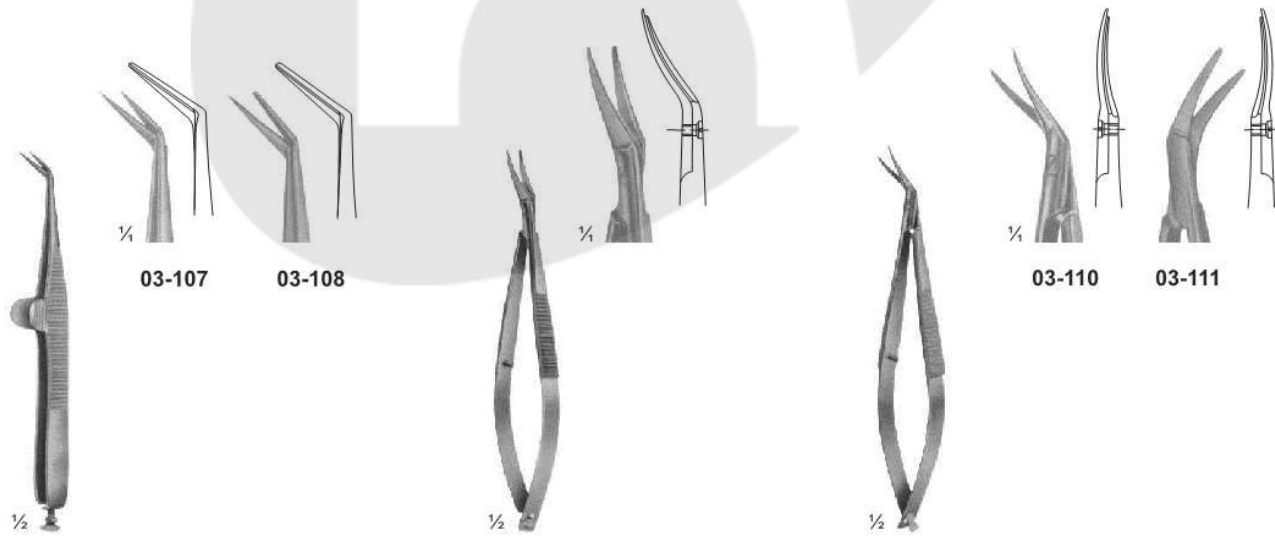

03-107 - 108
WECKER
Eye Scissor
Size: 110 mm

03-109
CASTROVIEJO
Eye Scissor
Size: 115 mm

03-110 - 111
CASTROVIEJO
Eye Scissor
Size: 110 mm

Micro Scissors, "Spring Type" Flat Handles

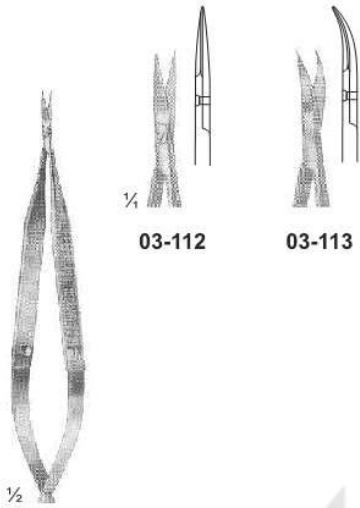

03-112

03-113

03-112 - 113
Size: 120 mm

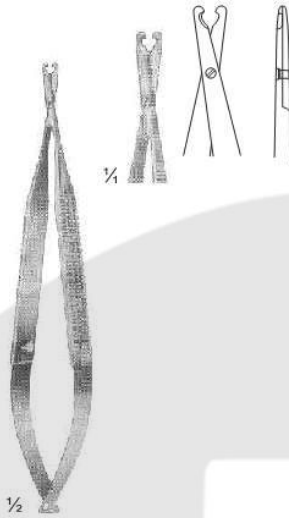

03-114
BIEMER
Vein Scissor
Size: 130 mm

03-115
Size: 160 mm

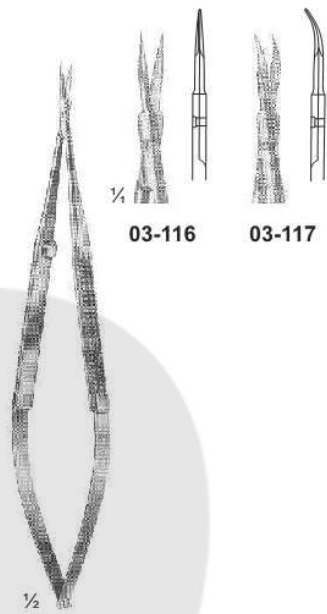

03-116

03-117

03-116 - 117
VANNAS
Size: 160 mm

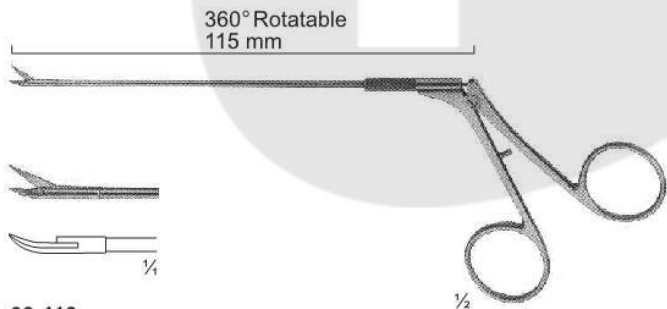

360° Rotatable
115 mm

03-118
CASPAR
Micro Scissor Curved
Size: 115 mm

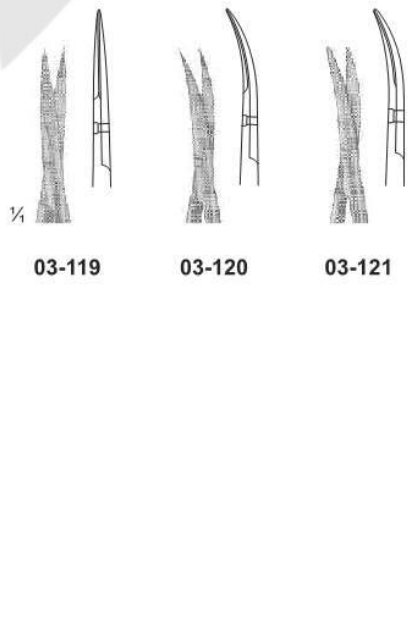

03-119

03-120

03-121

03-119 - 121
Micro Dissecting Scissor
Size: 145 mm

Micro Scissors, "Spring Type" Bayonet Shape

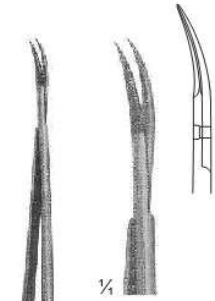

1/2
03-122
 YASARGIL
 Size: 245 mm

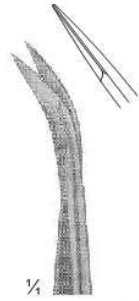

1/4
03-123



1/4
03-124

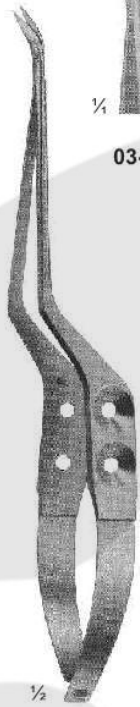

1/2
03-123 - 124
 Laterally Angled
 Size: 200 mm



1/2
03-125
 Laterally Angled
 Size: 190 mm



1/4
03-126

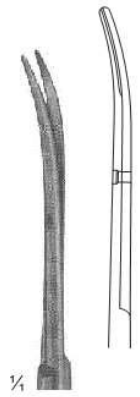

1/4
03-127



1/2
03-126 - 127
 YASARGIL
 Size: 225 mm

Delicate Scissors

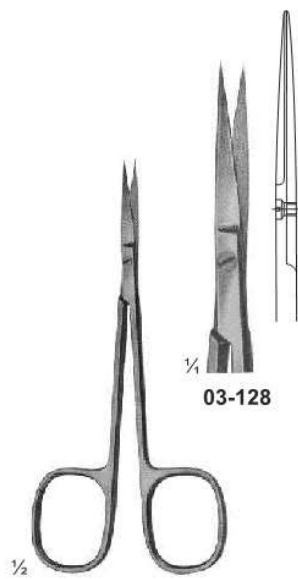

03-128



03-129

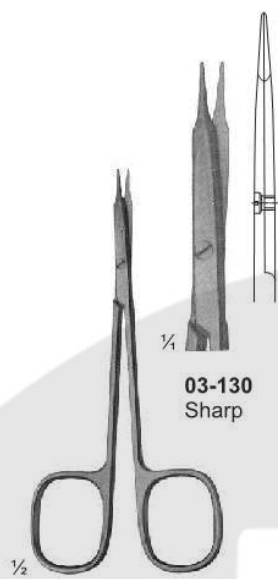

03-130
Sharp

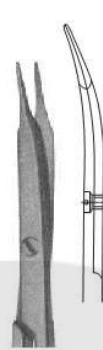

03-131
Sharp

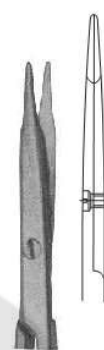

03-132
Blunt

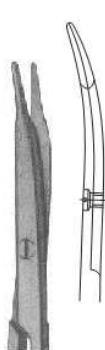

03-133
Blunt

03-128 - 129
Size: 120 mm

03-130 - 133
STEVENS
Dissecting Scissors
Size: 115 mm

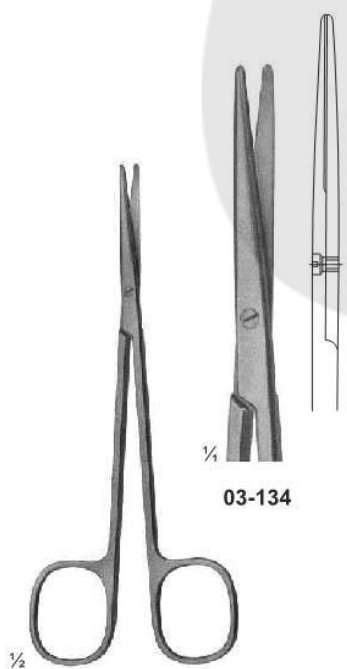

03-134

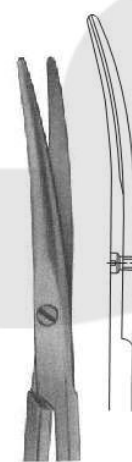

03-135

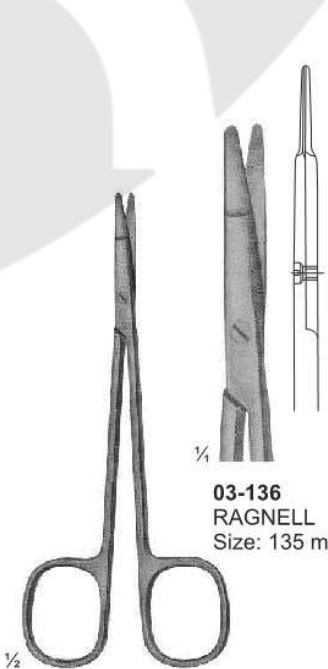

03-136
RAGNELL
Size: 135 mm

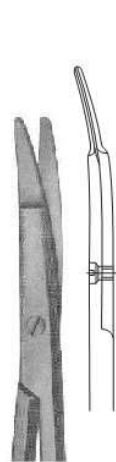

03-137
RAGNELL
Size: 135 mm

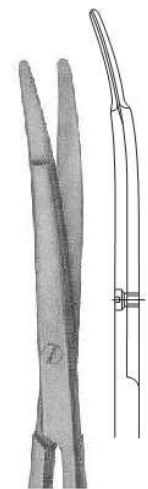

03-138
Size: 150 mm

03-134 - 135
METZENBAUM
Dissecting Scissors
Size: 145 mm

03-136 - 138
Special flat points for
dissecting and
undermining the skin
Size: 145 mm

Delicate Scissors

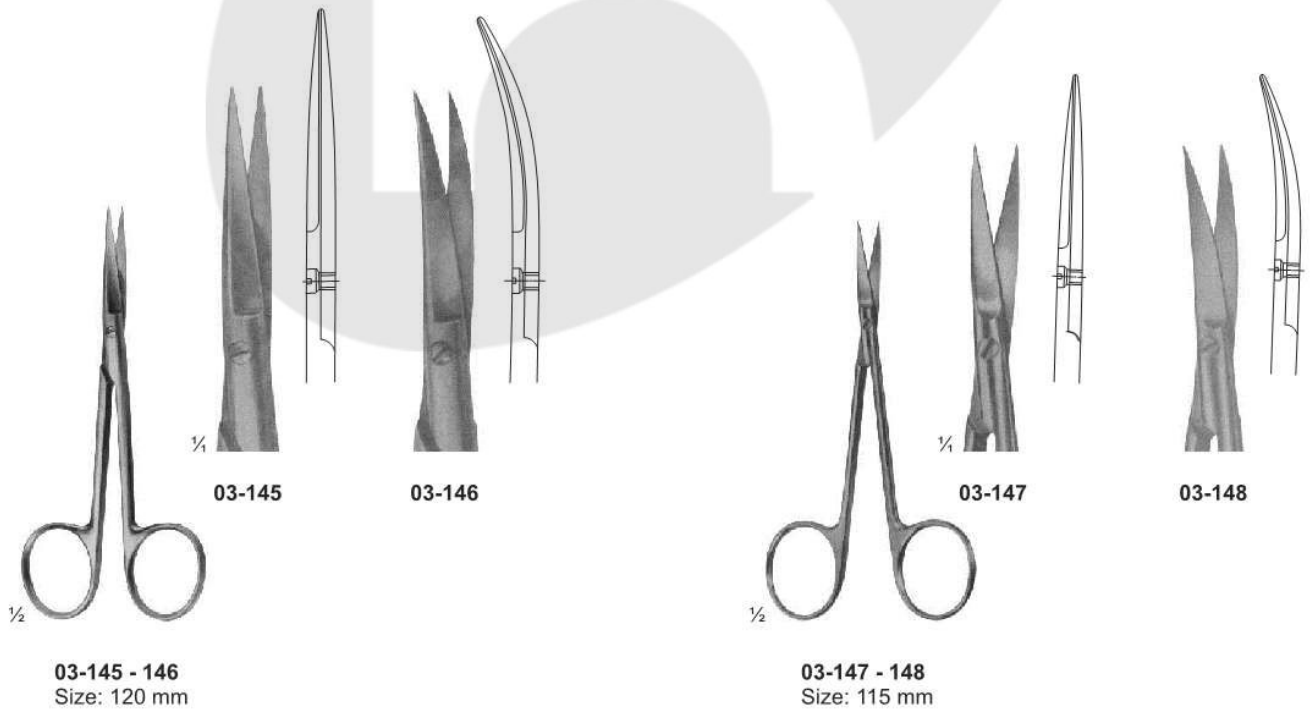
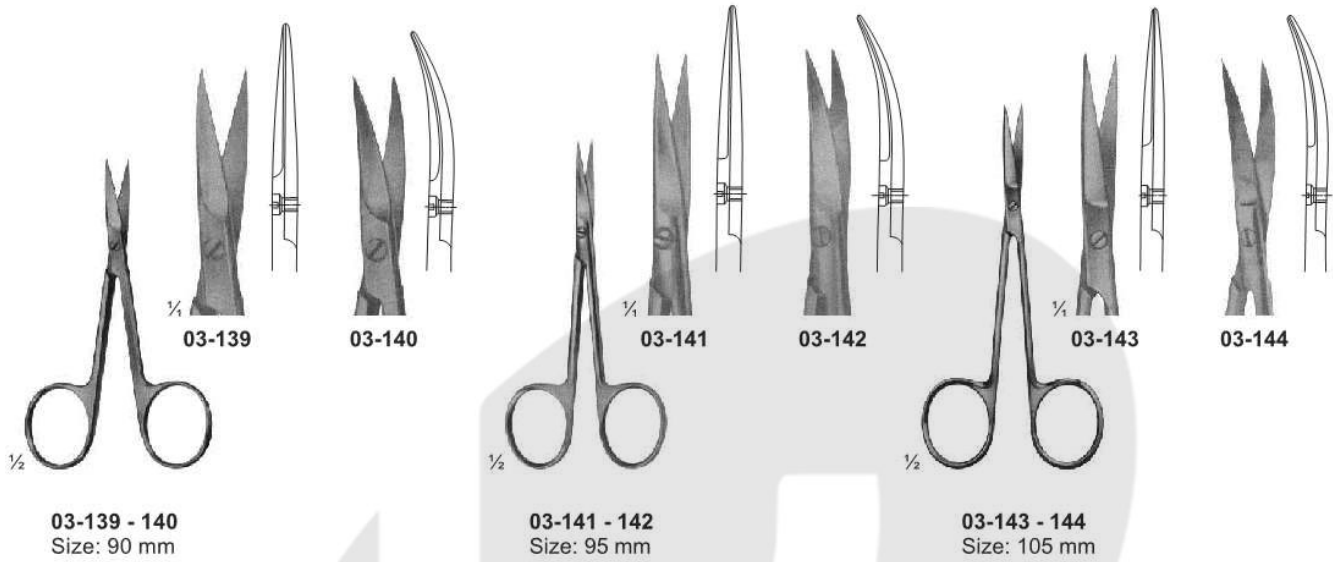

Delicate Scissors



03-149 - 151
Size: 120 mm

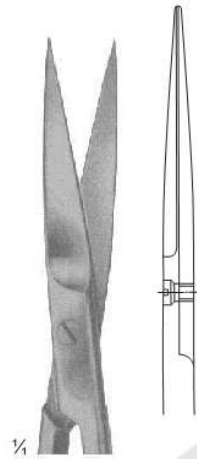

03-149

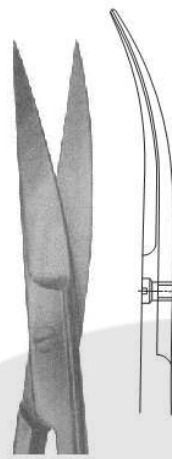

03-150

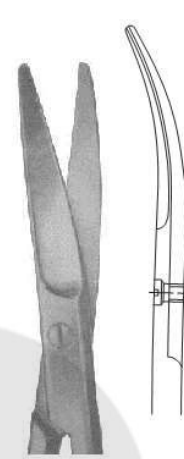

03-151



03-152 - 155
Size: 130 mm

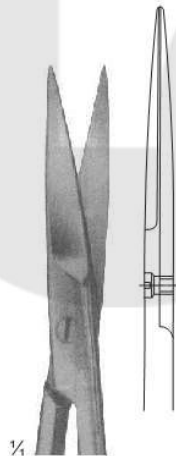

03-152

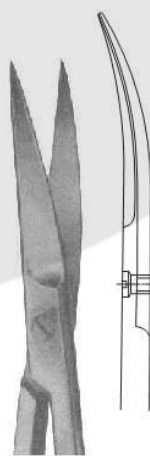

03-153

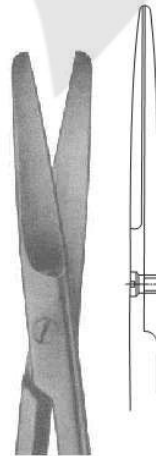

03-154

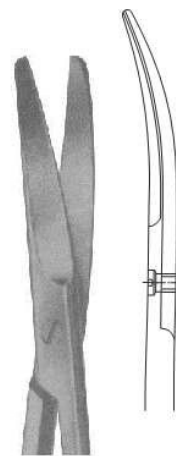

03-155

Delicate Scissors

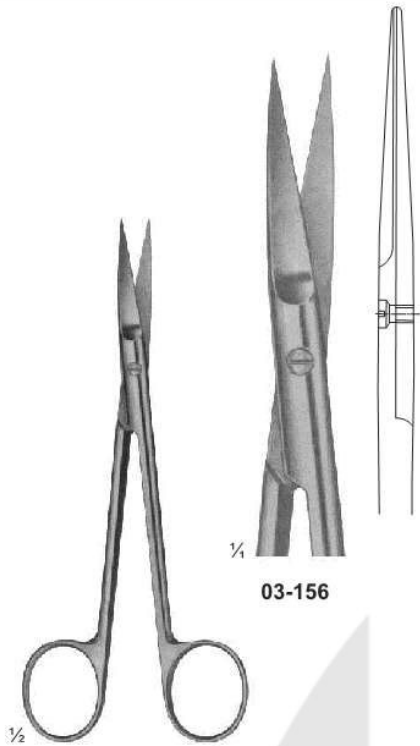

03-156

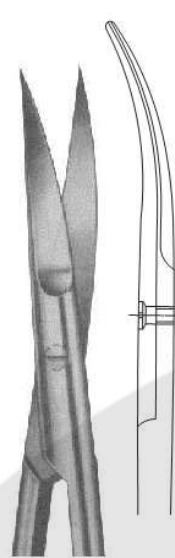

03-157

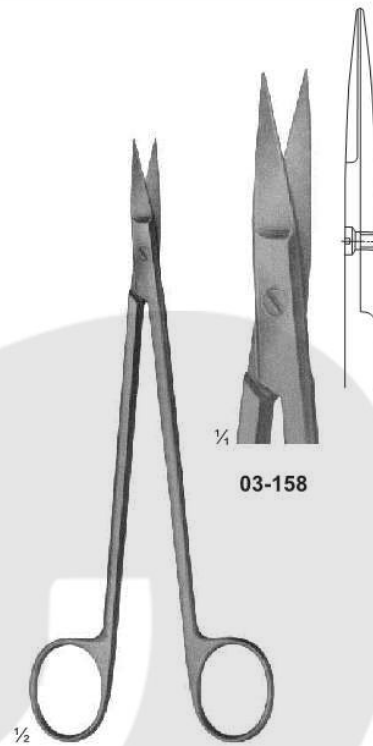

03-158

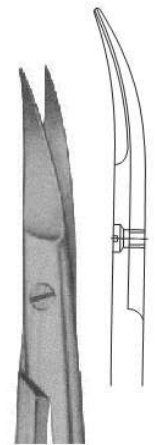

03-159

03-156 - 157
JOSEPH
Size: 150 mm

03-158 - 159
KELLY
Size: 175 mm

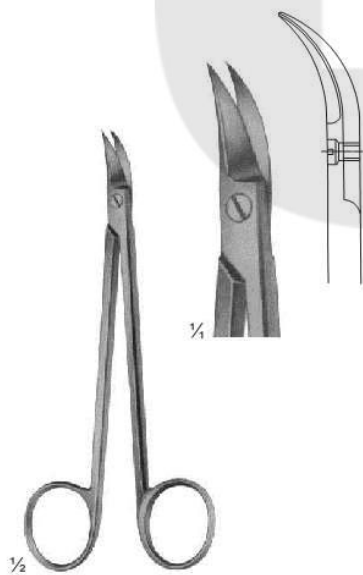

03-160
QUINBY
Size: 130 mm

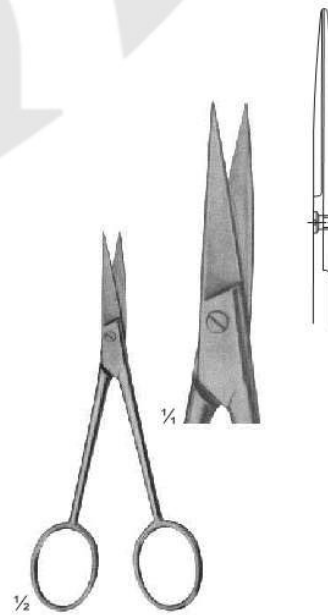

03-161
Size: 110 mm

Surgical Scissors

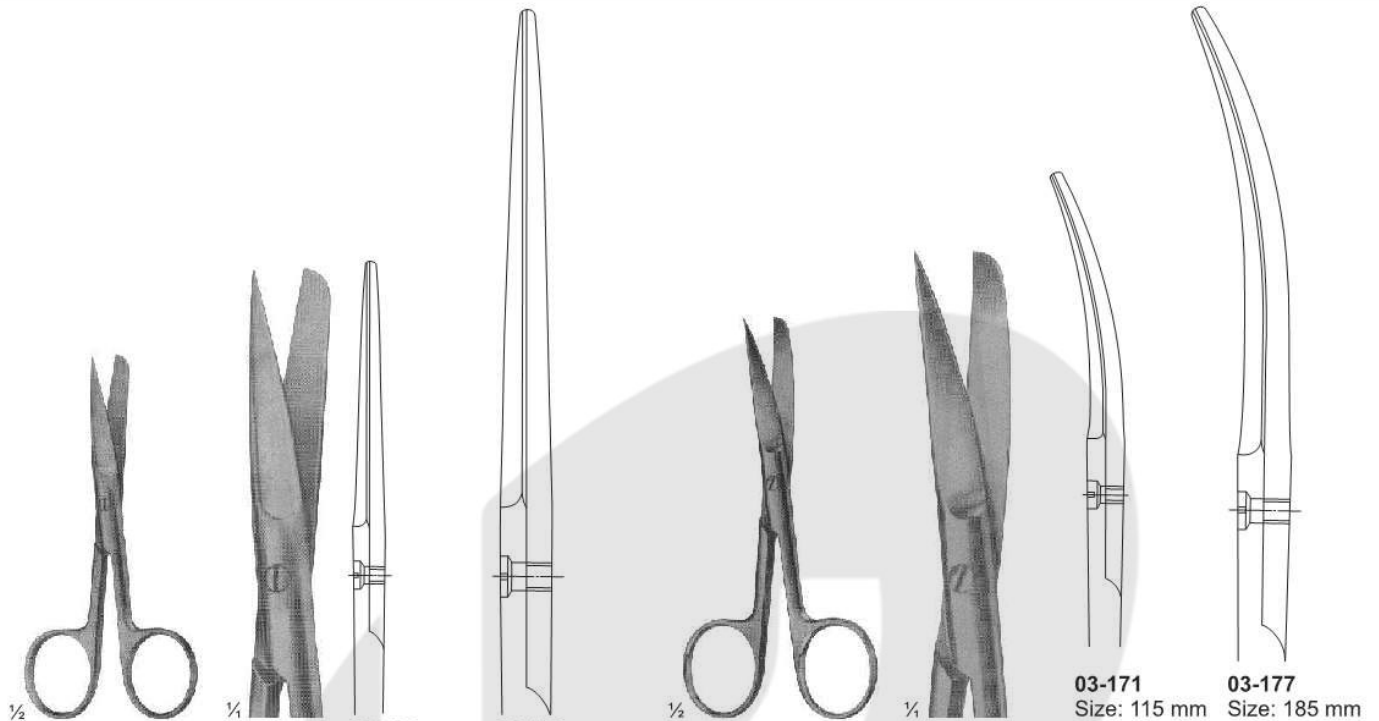

03-162 - 170 (Standard Types)

- 03-162 (105 mm)
- 03-163 (115 mm)
- 03-164 (130 mm)
- 03-165 (145 mm)
- 03-166 (150 mm)
- 03-167 (165 mm)
- 03-168 (175 mm)
- 03-169 (185 mm)
- 03-170 (200 mm)

03-162 Size: 105 mm
03-170 Size: 200 mm

03-171 - 177 (Standard Types)

- 03-171 (115 mm)
- 03-172 (130 mm)
- 03-173 (145 mm)
- 03-174 (150 mm)
- 03-175 (165 mm)
- 03-176 (175 mm)
- 03-177 (185 mm)

03-171 Size: 115 mm
03-177 Size: 185 mm

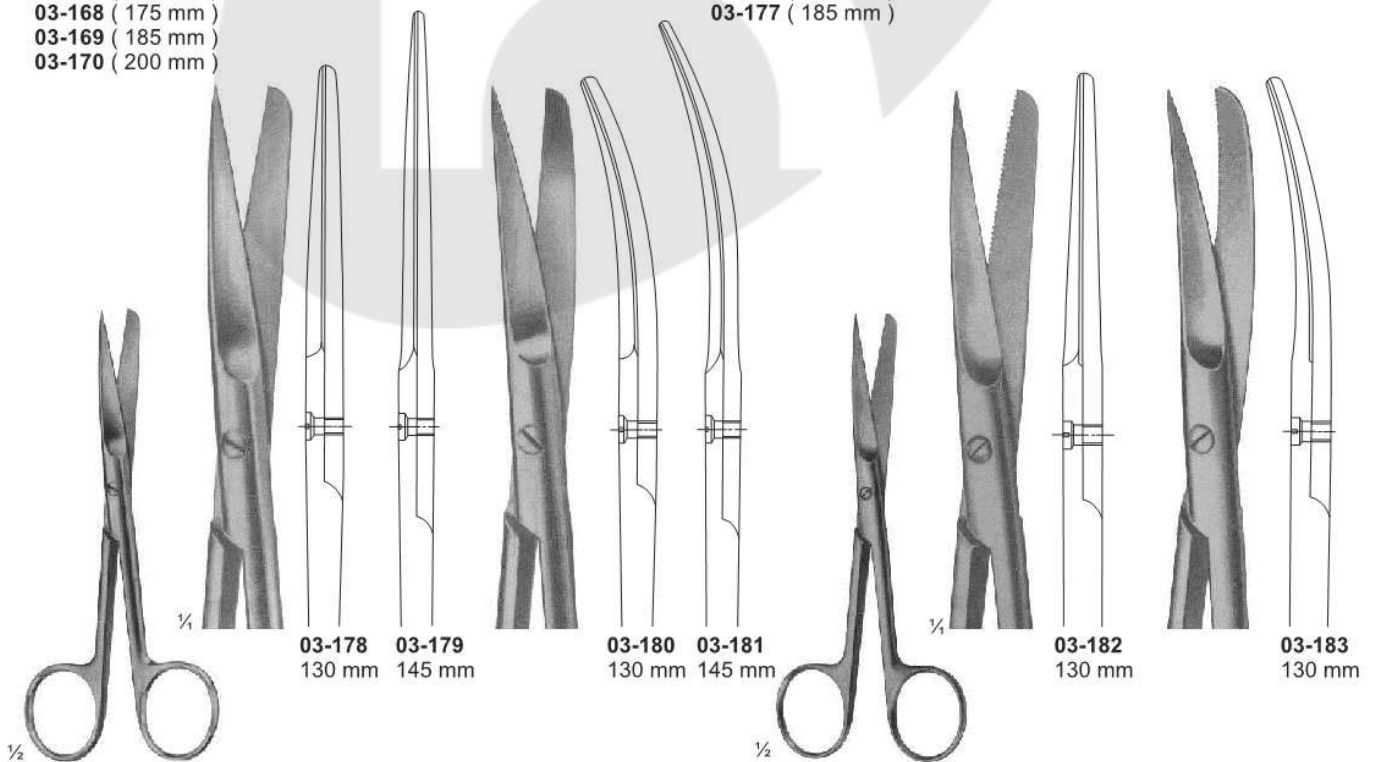

03-178 - 181
Slender Types

03-182 - 183
For Wound Edges
1 Blade Serrated

Surgical Scissors

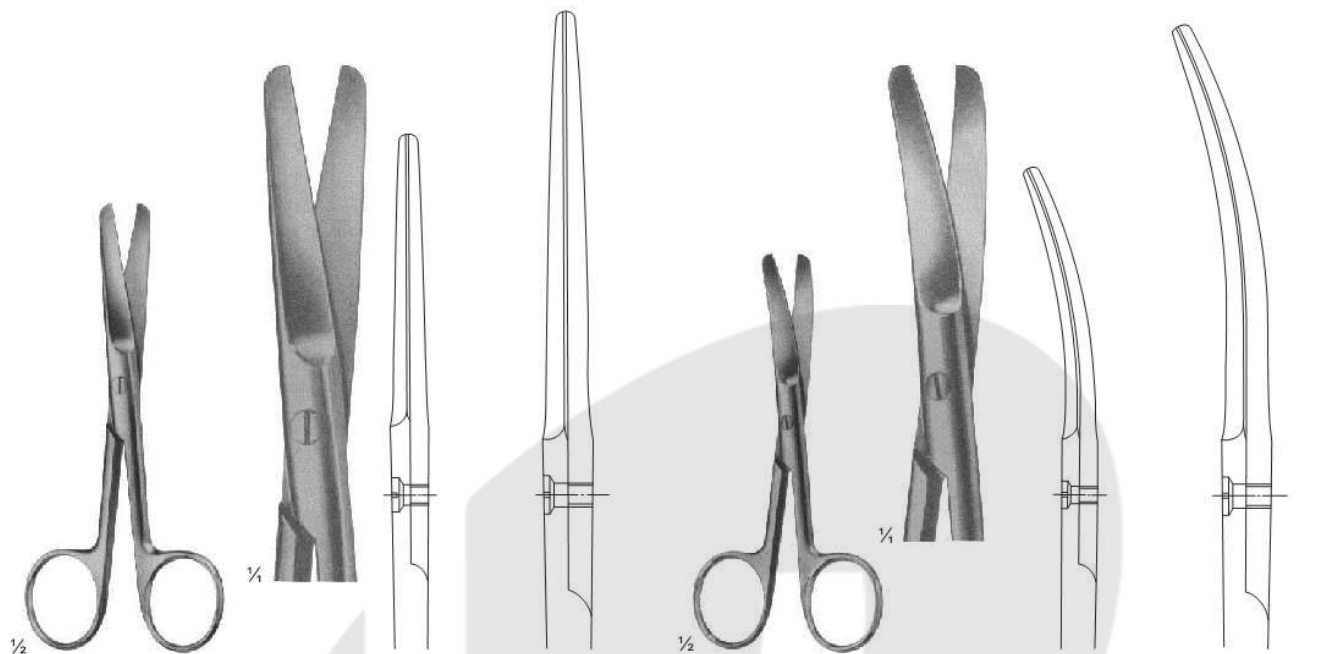

03-184 - 188 (Standard Types)
03-184 (130 mm)
03-185 (145 mm)
03-186 (150 mm)
03-187 (165 mm)
03-188 (175 mm)

03-184 Size: 130 mm
03-188 Size: 175 mm

03-189 - 194 - COOPER
 Standard Types
03-189 (115 mm)
03-190 (130 mm)
03-191 (145 mm)
03-192 (150 mm)
03-193 (165 mm)
03-194 (175 mm)

03-189 Size: 115 mm
03-194 Size: 175 mm

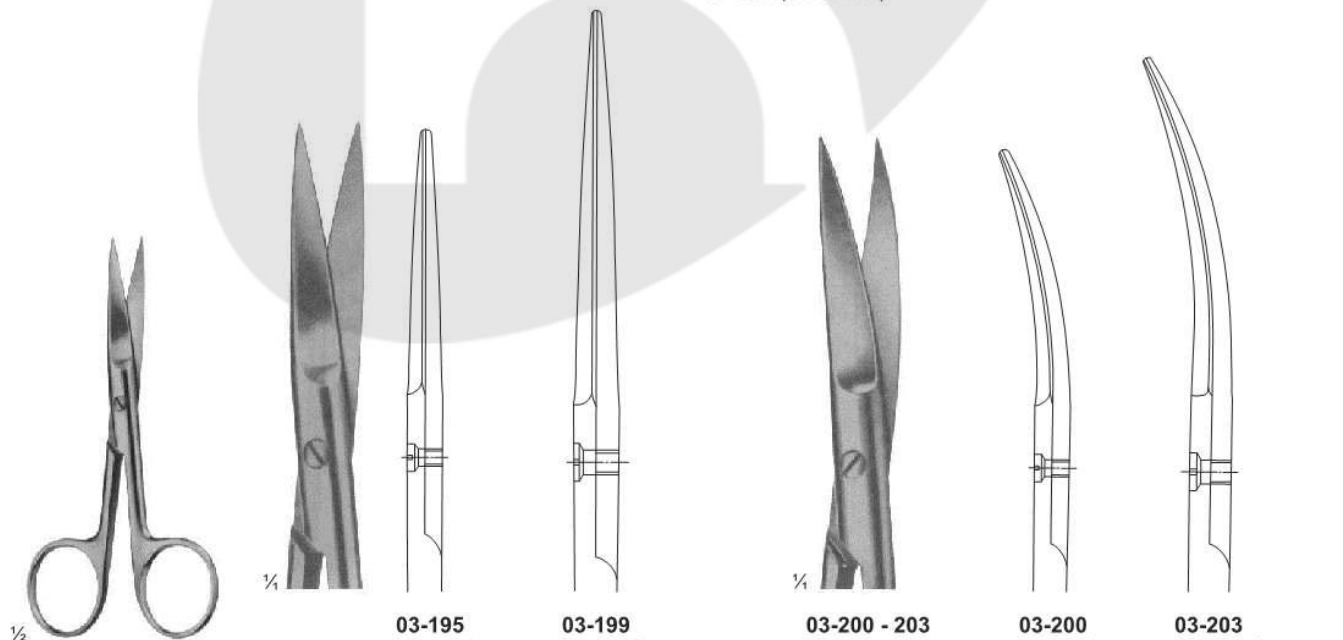

03-195 - 199
 Standard Types
03-195 (115 mm)
03-196 (130 mm)
03-197 (145 mm)
03-198 (150 mm)
03-199 (165 mm)

03-195 Size: 115 mm
03-199 Size: 165 mm

03-200 - 203
 Standard Types
03-200 (115 mm)
03-201 (130 mm)
03-202 (145 mm)
03-203 (150 mm)

03-200 Size: 115 mm
03-203 Size: 150 mm

Surgical Scissors

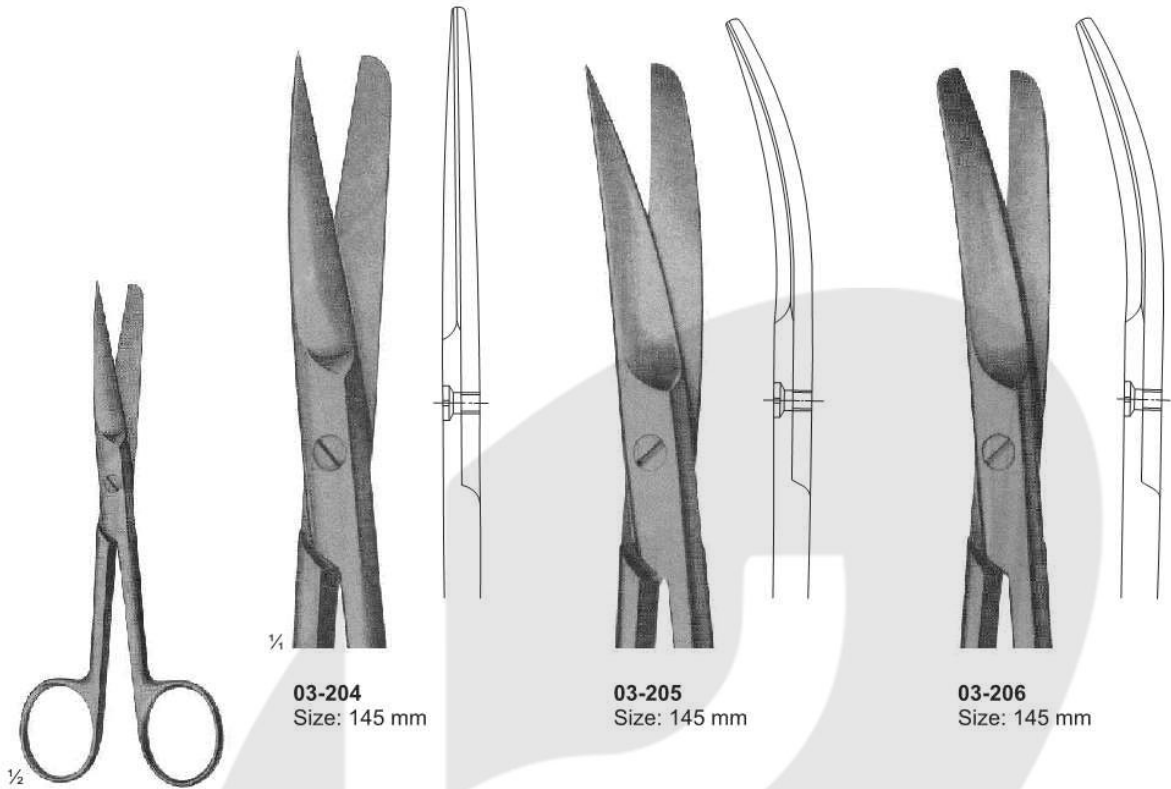

03-204
Size: 145 mm

03-205
Size: 145 mm

03-206
Size: 145 mm

03-204 - 206
DEAVER
With flat lock

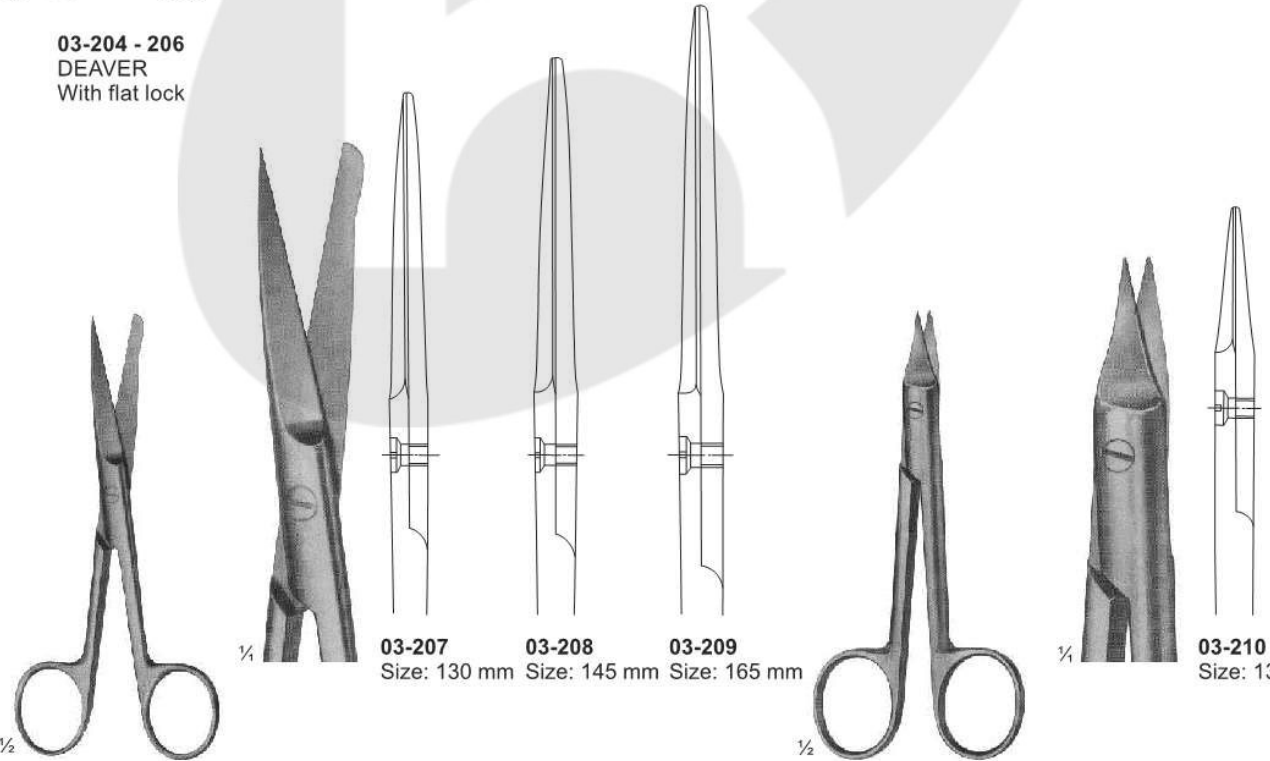

03-207
Size: 130 mm

03-208
Size: 145 mm

03-209
Size: 165 mm

03-210
Size: 130 mm

03-207 - 209
Incision Scissors

03-210
SYSTRUNK
Nail Splitting Scissors

Dissecting Scissors

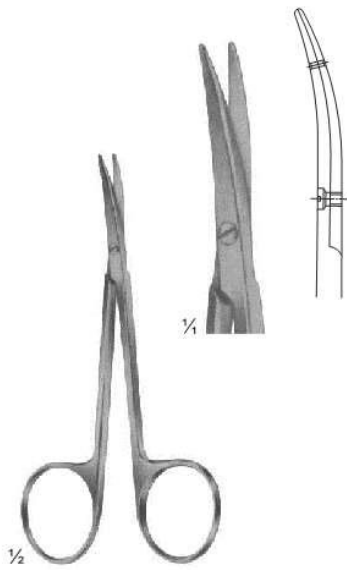

03-211
LITTLER
Dissecting Scissors
Tips with eye for suture
Size: 115 mm

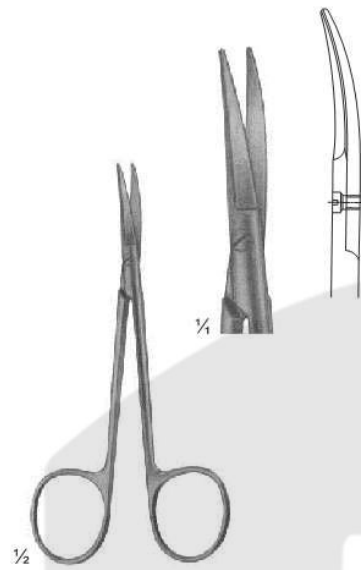

03-212
COTTLE
Bulldog Scissors
Size: 115 mm

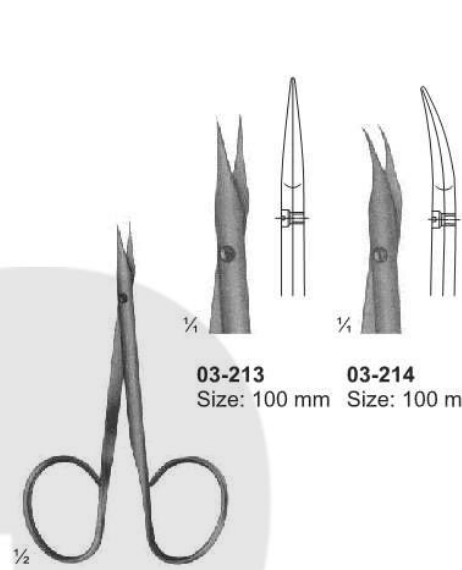

03-213 - 214
STEVENS
Vessel and tendon Scissors
Size: 100 mm

03-213 Size: 100 mm
03-214 Size: 100 mm

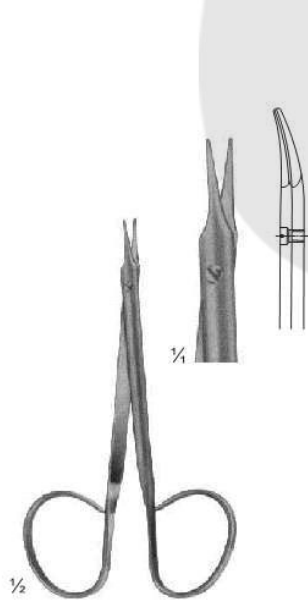

03-215
STEVENS
Fine Dissecting Scissors
Size: 110 mm

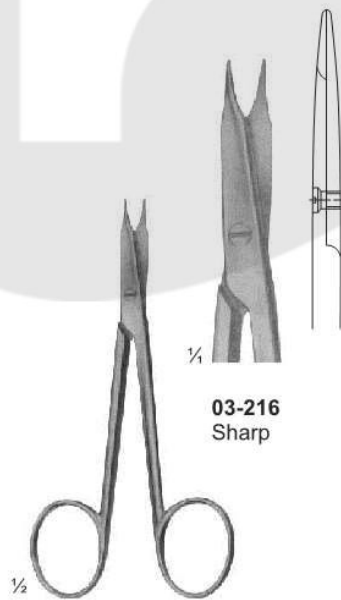

03-216 - 219
STEVENS
Vessel and tendon Scissors
Size: 110 mm

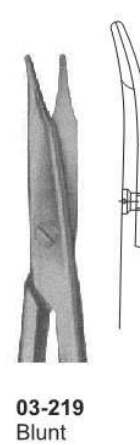
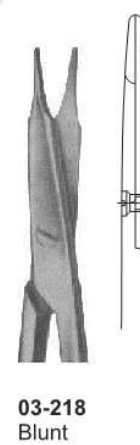
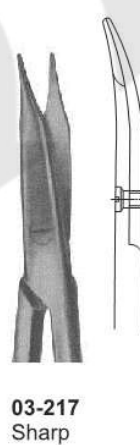

Dissecting Scissors

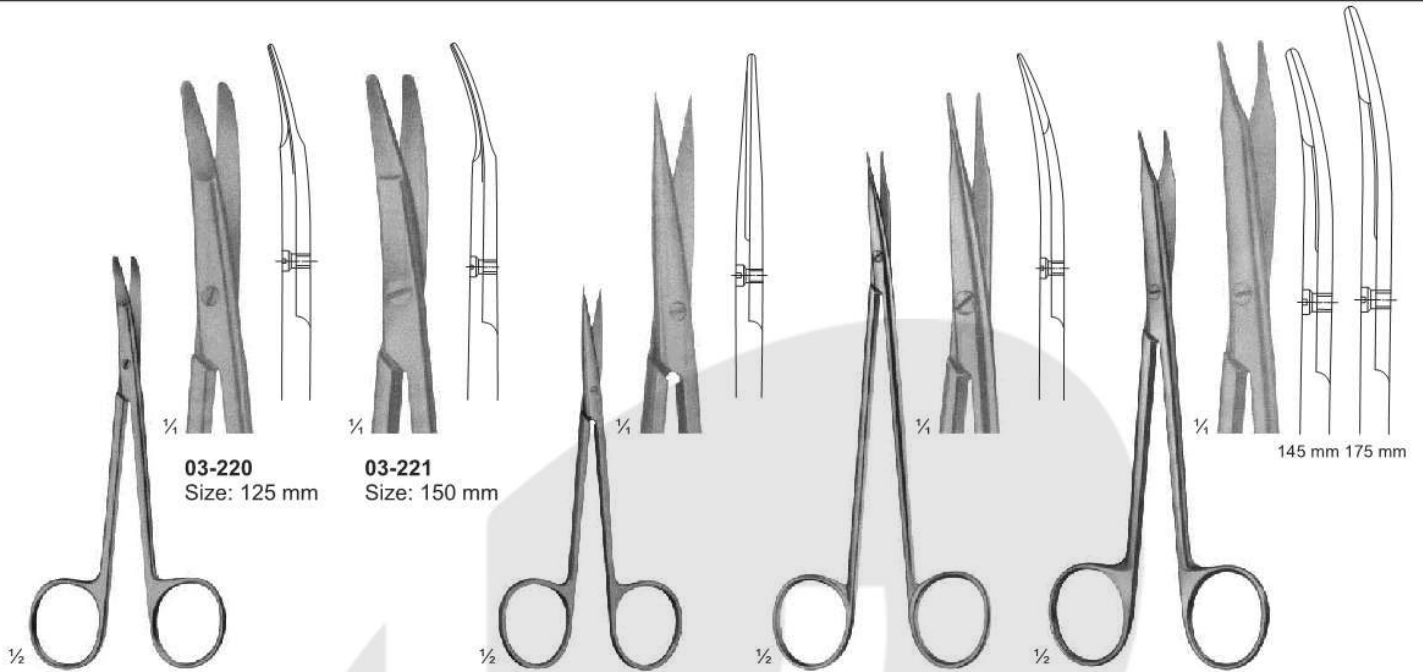

03-220
Size: 125 mm

03-221
Size: 150 mm

145 mm 175 mm

03-220 - 221
KILNER
Special flat points for dissecting and undermining the skin

03-222
KILNER
Fine dissecting scissors
Size: 115 mm

03-223
JAMESON
Dissecting scissors
Size: 150 mm

03-224
REYNOLDS
Dissecting scissors
Size: 145 - 175 mm

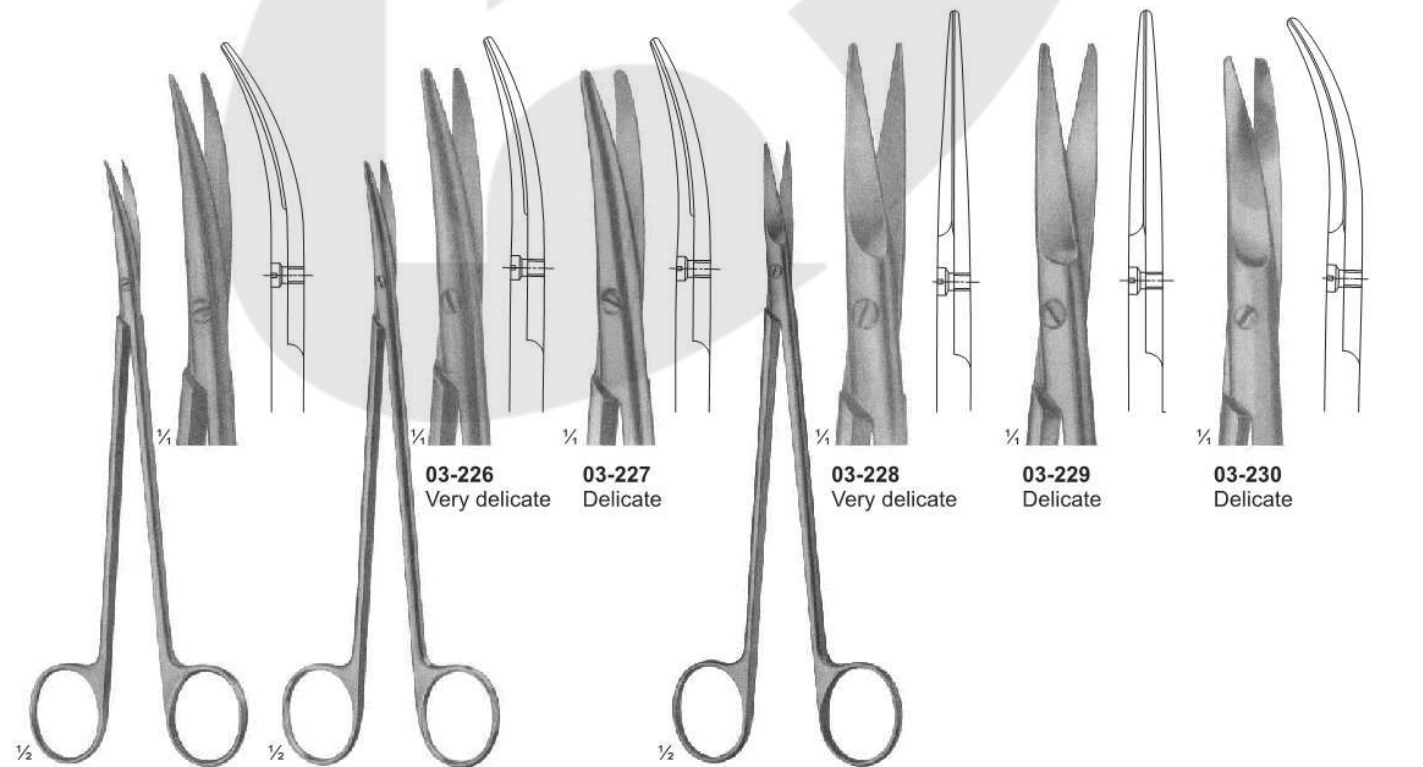

03-225
DE BAKEY
Ateriotomy scissors
Size: 175 mm

03-226 - 227
TOENNIS ADSON
Dissecting scissors
Size: 175 mm

03-228 - 230
TOENNIS
Dissecting scissors
Size: 150 mm

Dissecting & Surgical Scissors



03-231
Size: 115 mm

03-232
Size: 135 mm

03-233

03-234

03-231 - 232
FOMON
Lower lateral scissors

03-233 - 234
LANDOLT
Enucleation scissors
Size: 120 mm

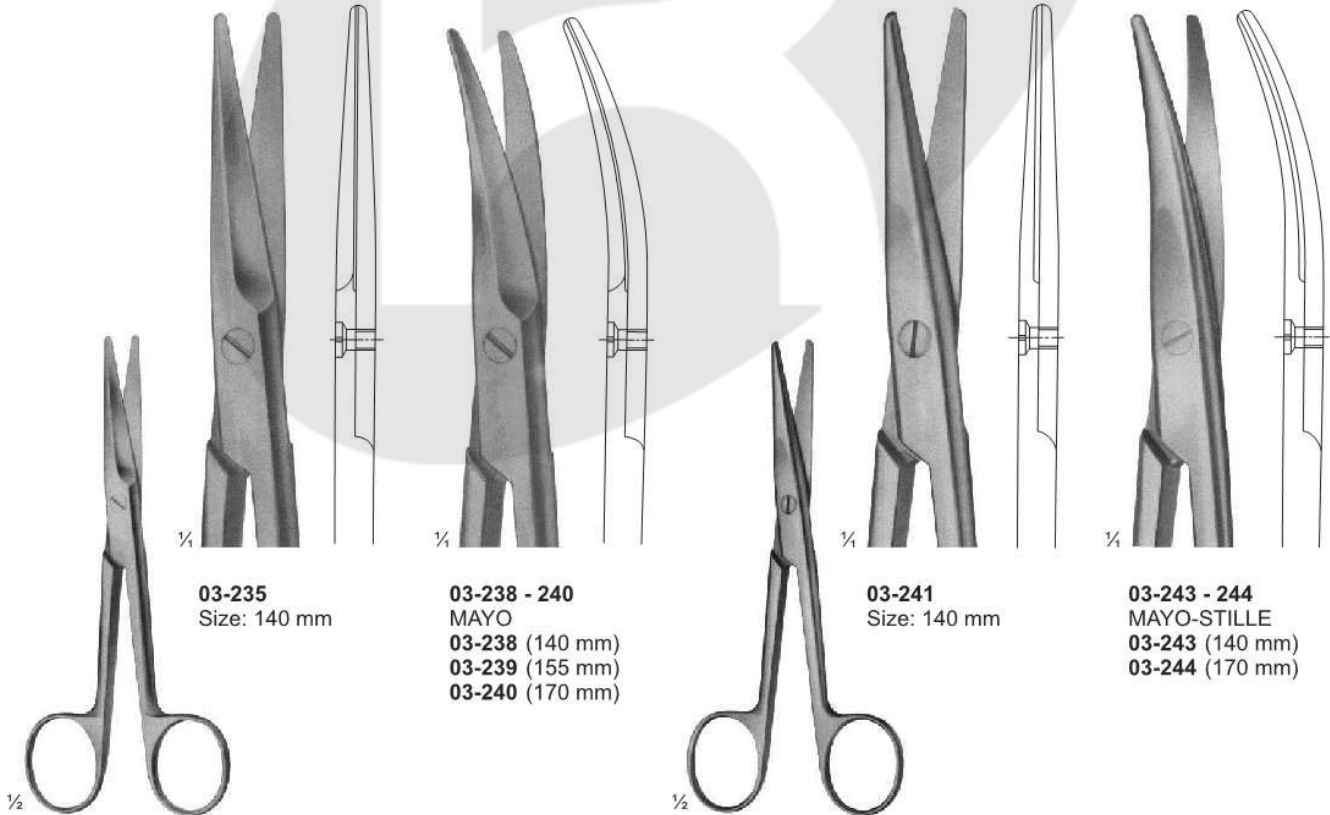

03-235
Size: 140 mm

03-238 - 240
MAYO
03-238 (140 mm)
03-239 (155 mm)
03-240 (170 mm)

03-241
Size: 140 mm

03-243 - 244
MAYO-STILLE
03-243 (140 mm)
03-244 (170 mm)

03-235 - 237
MAYO
03-235 (140 mm)
03-236 (155 mm)
03-237 (170 mm)

03-241 - 242
MAYO-STILLE
03-241 (140 mm)
03-242 (170 mm)

Dissecting Scissors

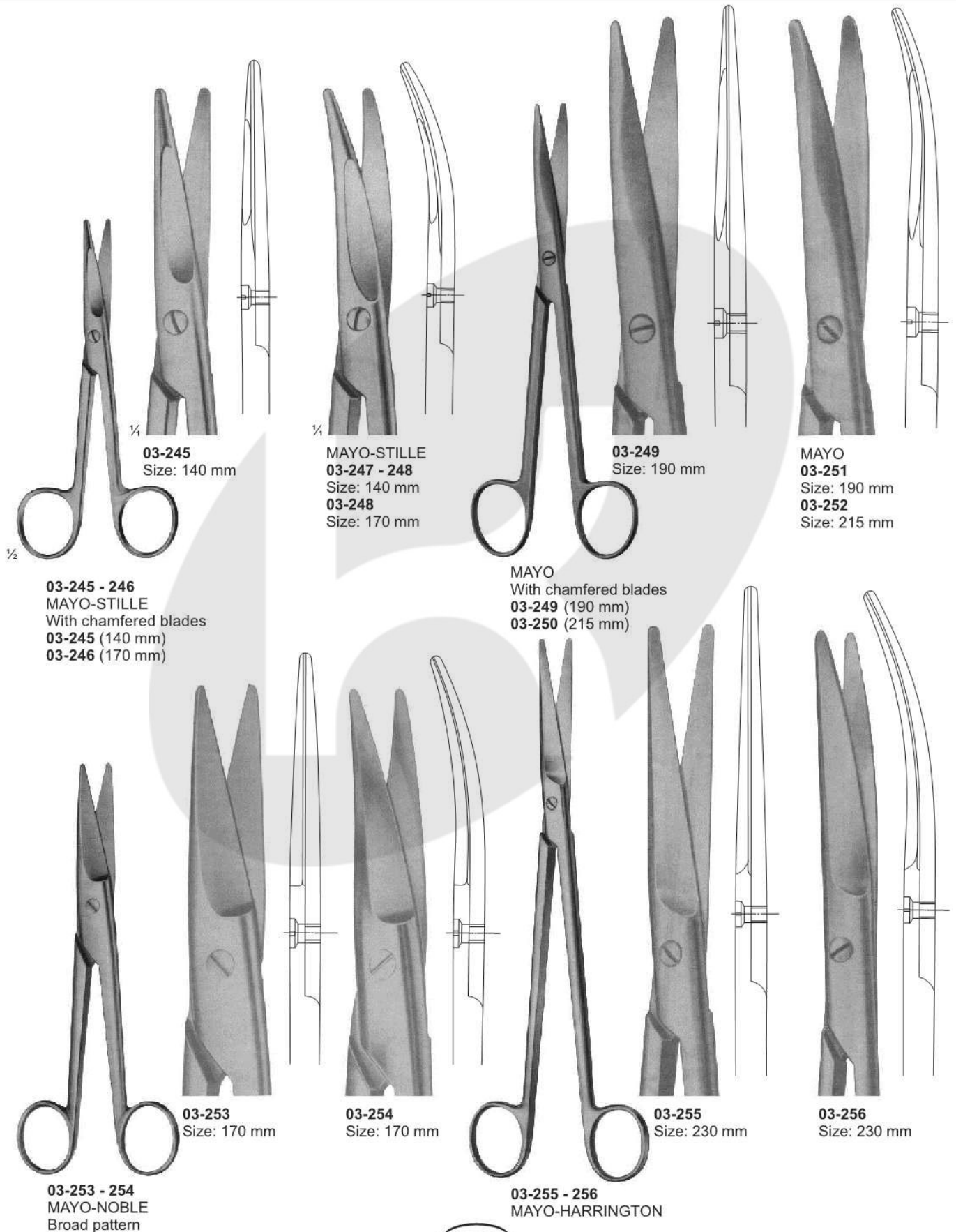

03-245
Size: 140 mm

MAYO-STILLE
03-247 - 248
Size: 140 mm
03-248
Size: 170 mm

03-249
Size: 190 mm

MAYO
03-251
Size: 190 mm
03-252
Size: 215 mm

03-245 - 246
MAYO-STILLE
With chamfered blades
03-245 (140 mm)
03-246 (170 mm)

MAYO
With chamfered blades
03-249 (190 mm)
03-250 (215 mm)

03-253
Size: 170 mm

03-254
Size: 170 mm

03-255
Size: 230 mm

03-256
Size: 230 mm

03-253 - 254
MAYO-NOBLE
Broad pattern

03-255 - 256
MAYO-HARRINGTON

Dissecting Scissors

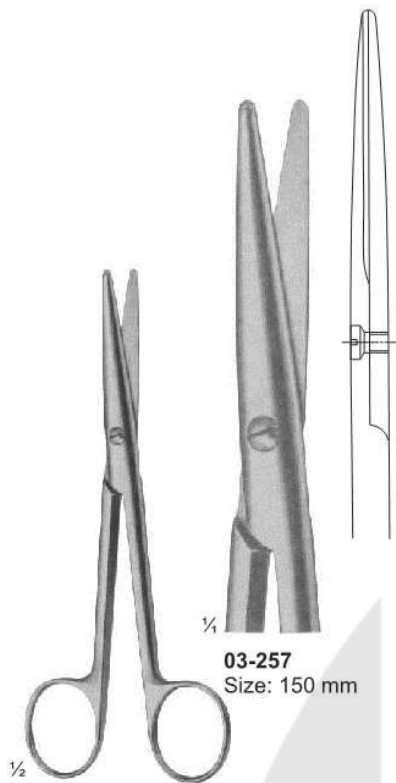

03-257
Size: 150 mm

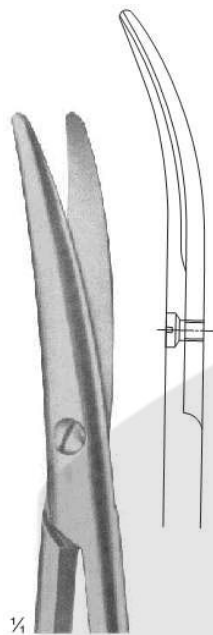

03-258
Size: 150 mm

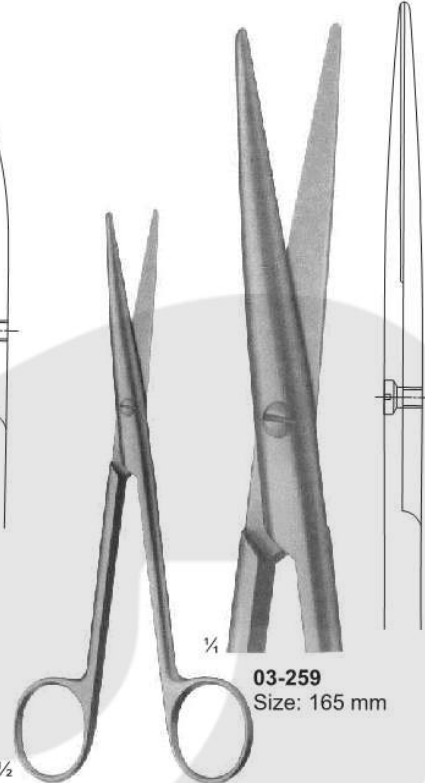

03-259
Size: 165 mm

03-260
Size: 165 mm

03-257 - 258
STILLE
Size: 150 mm

03-259 - 260
LEXER
Narrow
Size: 165 mm

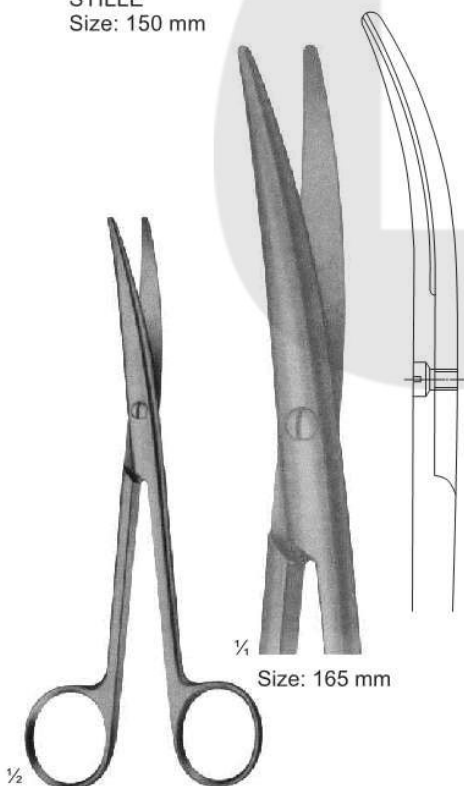

Size: 165 mm

03-262
Size: 165 mm

03-261
MAYO-LEXER
Standard

03-262 - 263
MAYO
03-262 (165 mm)
03-263 (200 mm)

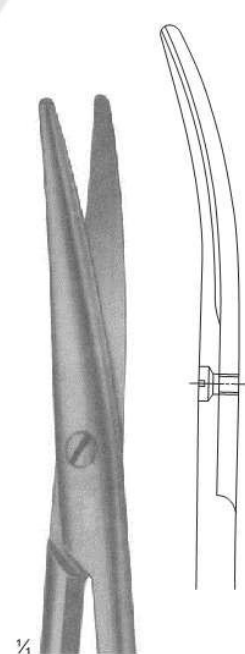

MAYO
03-264 - 266
Size: 165 mm

03-265
Size: 200 mm
03-266
Size: 210 mm

Dissecting Scissors

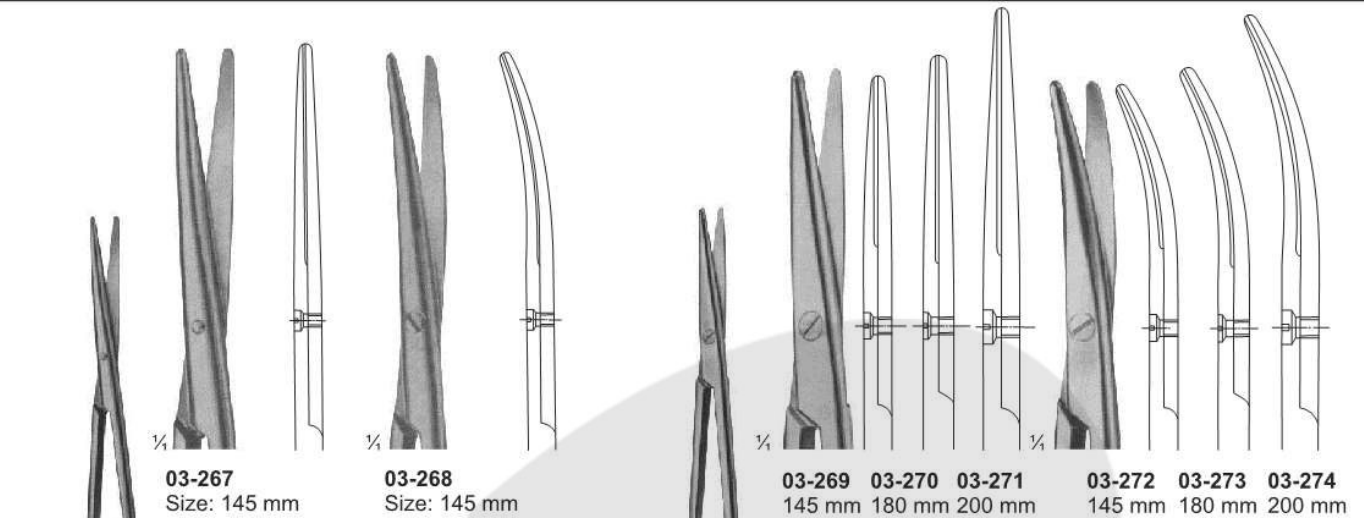

03-267
Size: 145 mm

03-268
Size: 145 mm

03-269 145 mm

03-270 180 mm

03-271 200 mm

03-272 145 mm

03-273 180 mm

03-274 200 mm

03-267 - 268
BABY - METZENBAUM

03-269 - 274
METZENBAUM

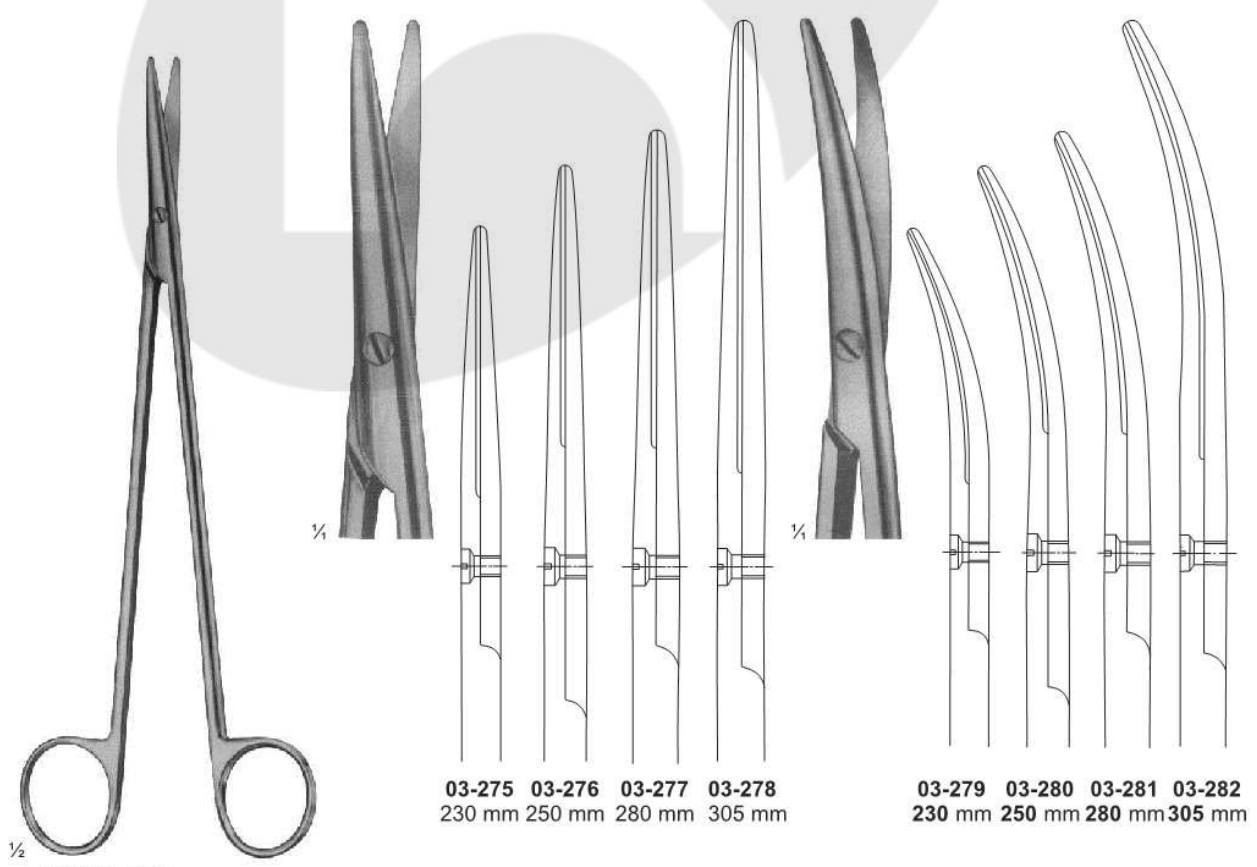

03-275 230 mm

03-276 250 mm

03-277 280 mm

03-278 305 mm

03-279 230 mm

03-280 250 mm

03-281 280 mm

03-282 305 mm

03-275 - 282
NELSON - METZENBAUM

Vessel Scissors

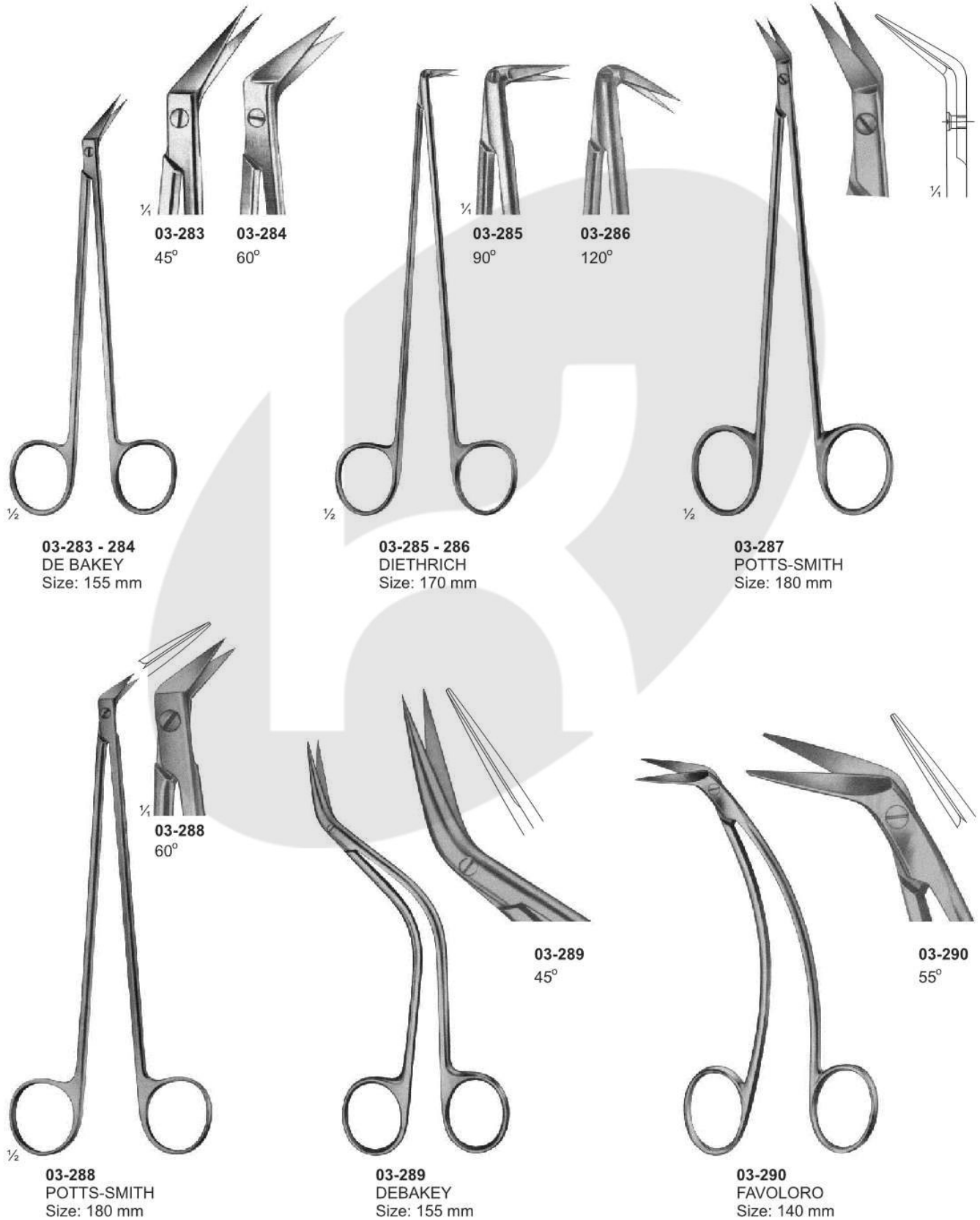

Cardiovascular and Neuro-Surgery Scissors



03-291
OLIVECRONA
Dura Scissors



03-292
STRULLY
Pointed
Size: 220 mm

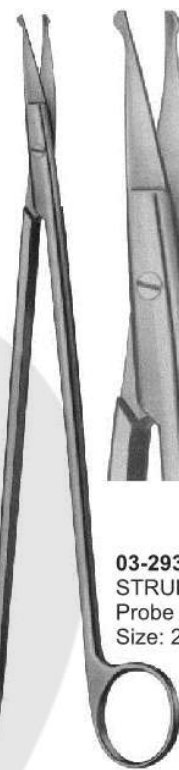

03-293
STRULLY
Probe Pointed
Size: 220 mm

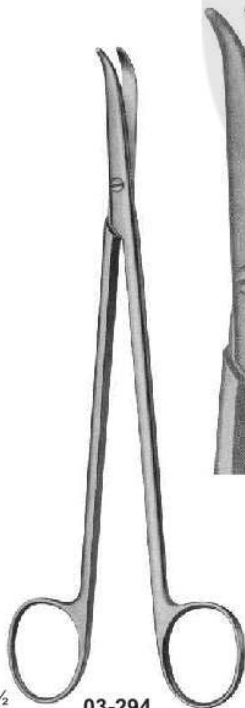
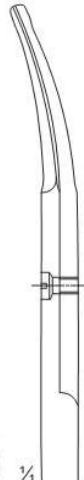

03-294
THOREK
Size: 180 mm

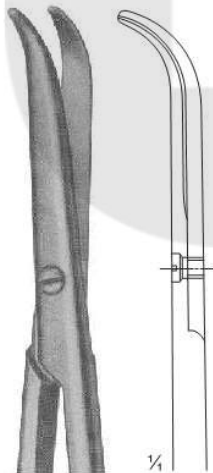

03-295
POTTS-SMITH
Size: 190 mm

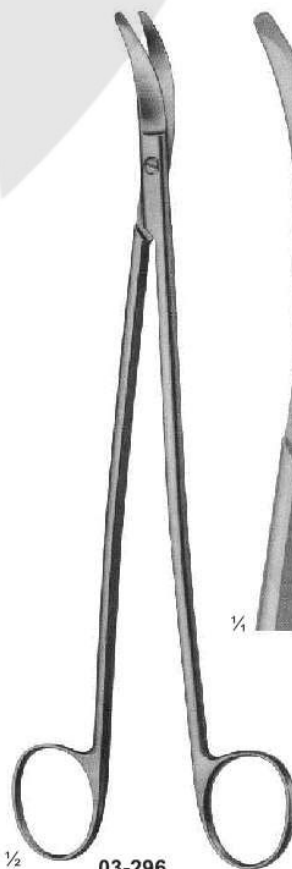
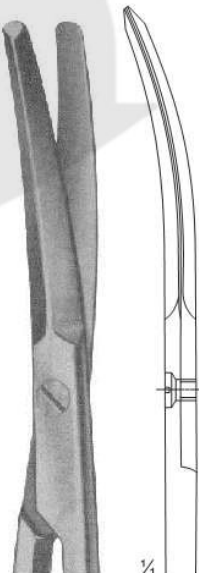

03-296
SATINSKY
Size: 245 mm

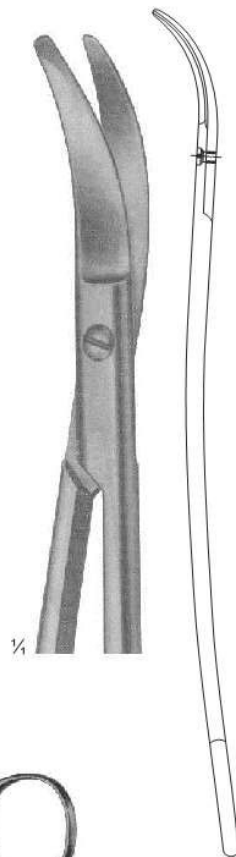

Delicate, Nasal and Tonsil Scissors

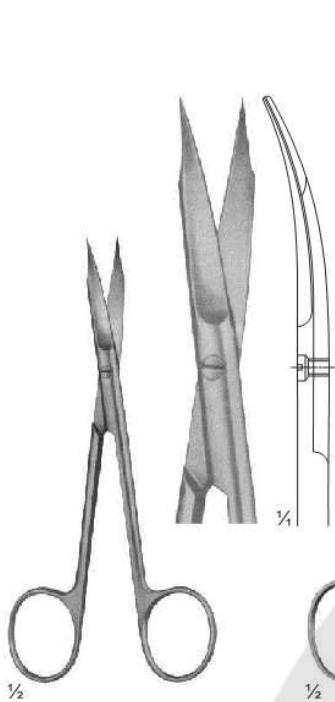

03-297
1 Finely Toothed Blade
Size: 130 mm

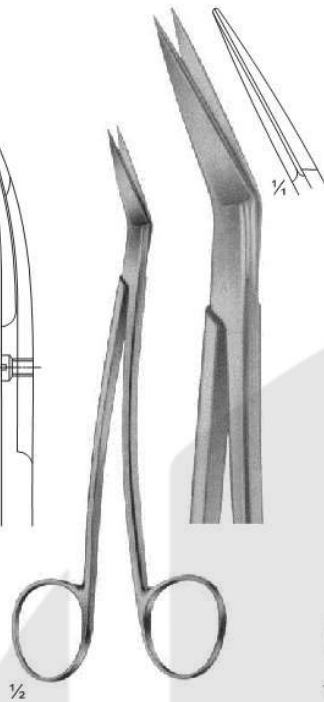

03-298
LOCKLIN
Curved Sideways,
1 Toothed Blade
Size: 155 mm

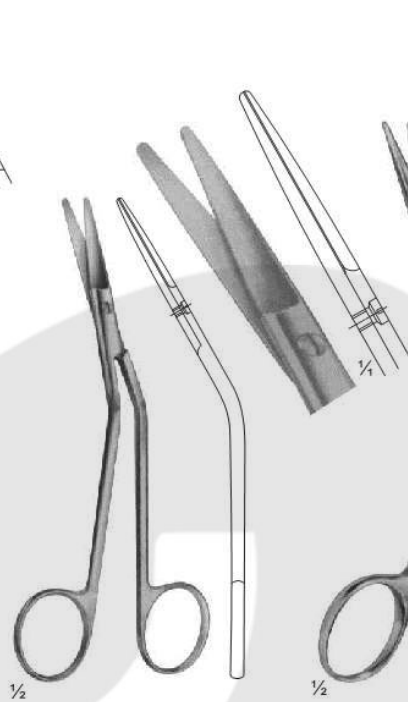

03-299
FOMON
Blades Serrated
Size: 145 mm

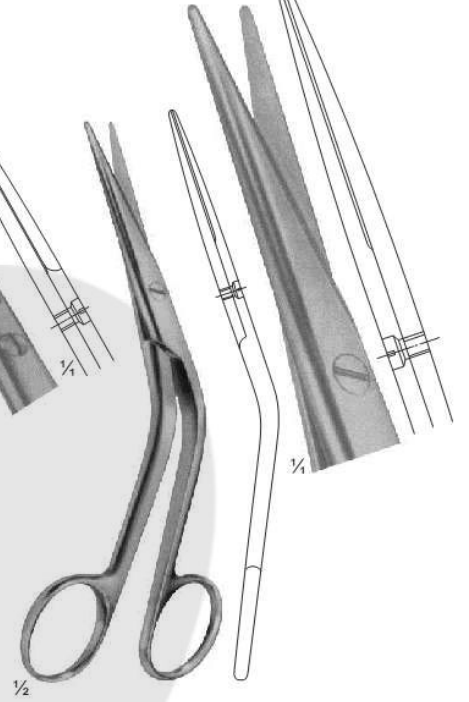

03-300
COTTLE
Size: 165 mm

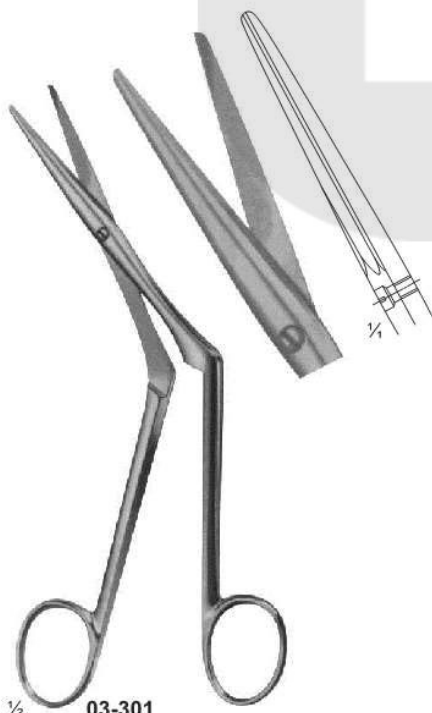

03-301
HEYMANN-KNIGHT
Size: 175 mm

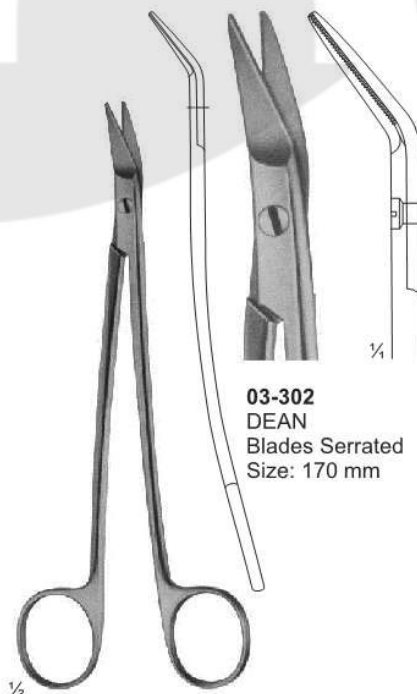

03-302
DEAN
Blades Serrated
Size: 170 mm

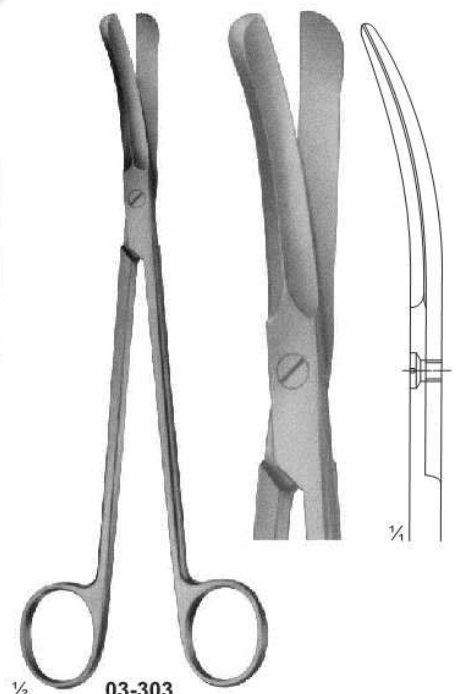

03-303
GOOD
Size: 195 mm

Bone Shears

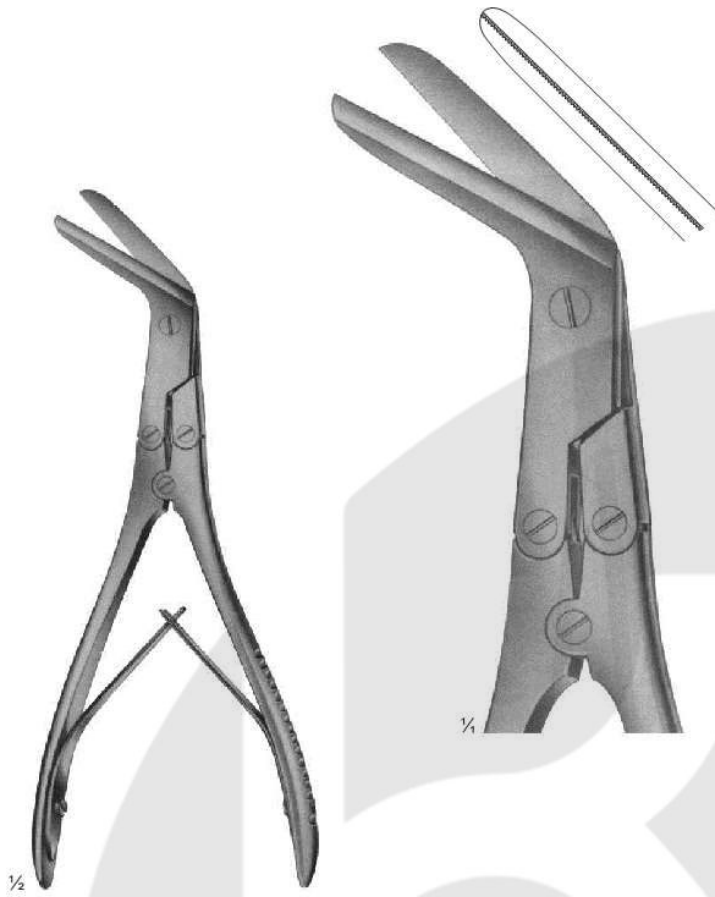

03-304
KILLIAN
Size: 200 mm



03-305 - 306

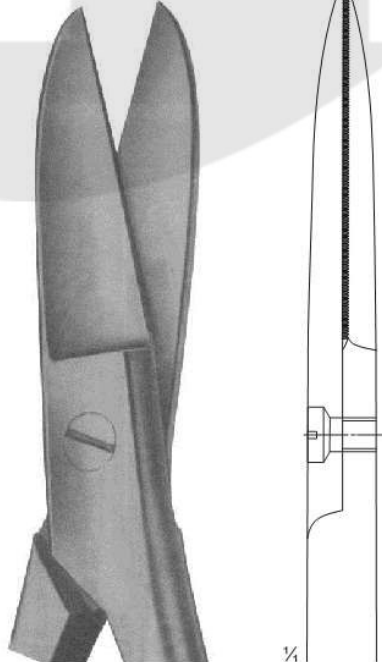

03-305
195 mm

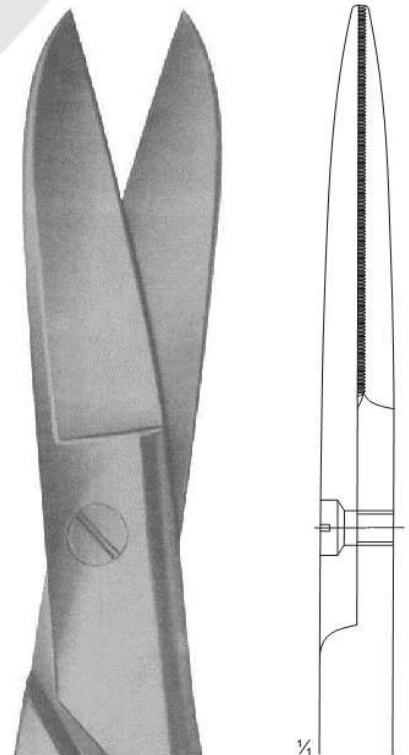

03-306
225 mm

Operating and Gynaecology Scissors

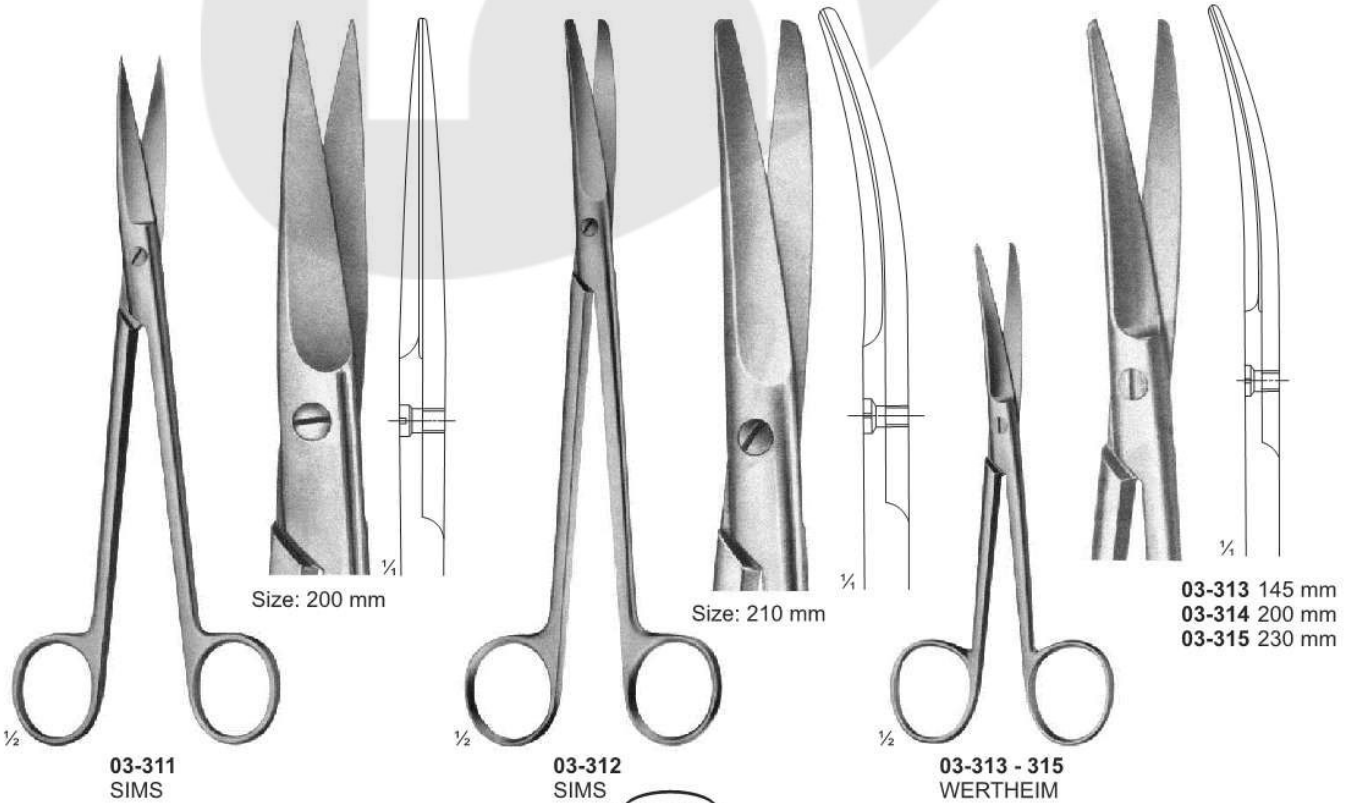
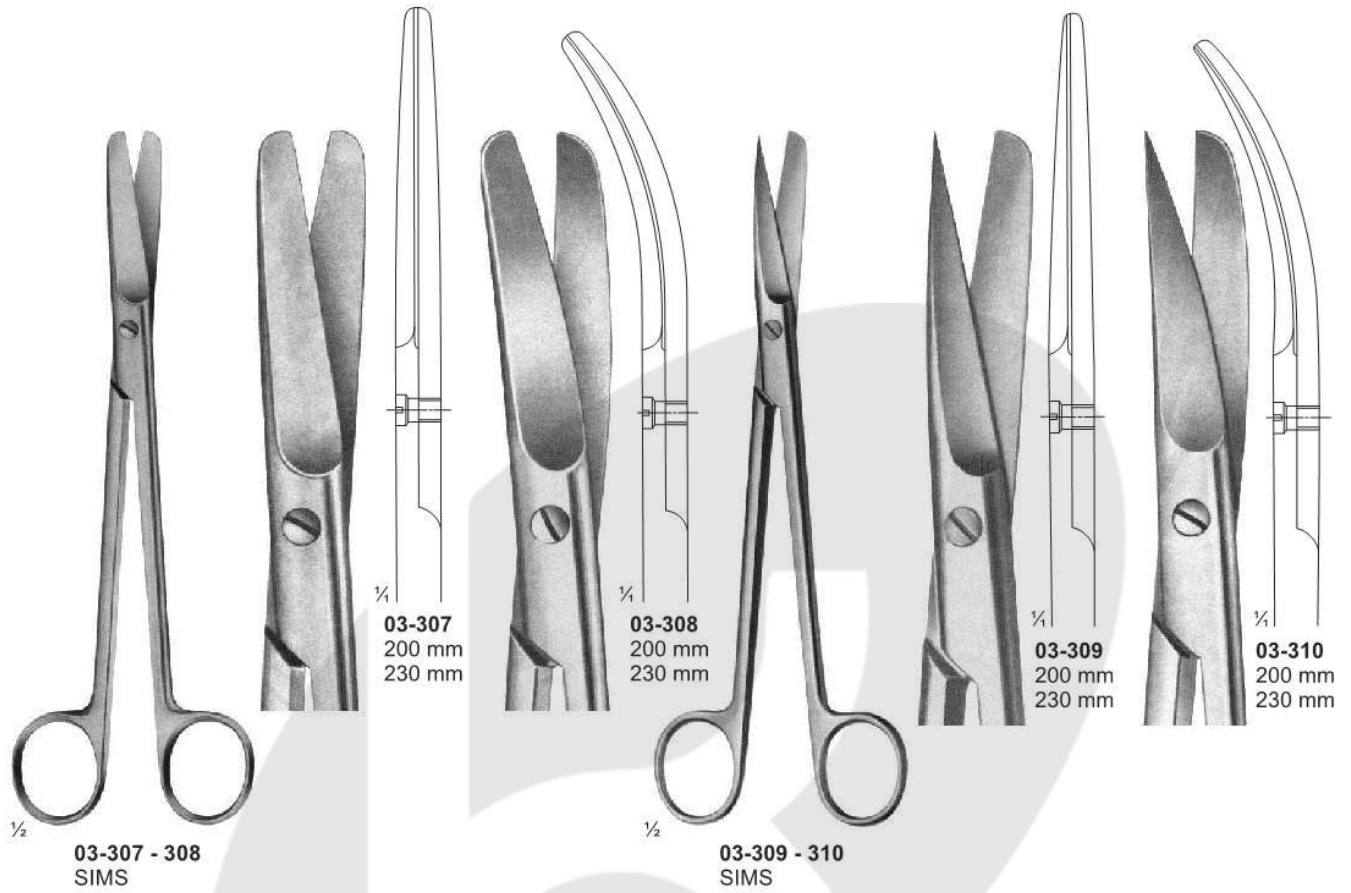

Operating and Gynaecology Scissors



03-316
SIEBOLD
Uterine Scissors
Size: 245 mm

03-317
BOZEMANN
Uterine Scissors
Size: 220 mm

03-318
SIMS-SIEBOLD
Uterine Scissors
Size: 250 mm

Operating and Gynaecology Scissors

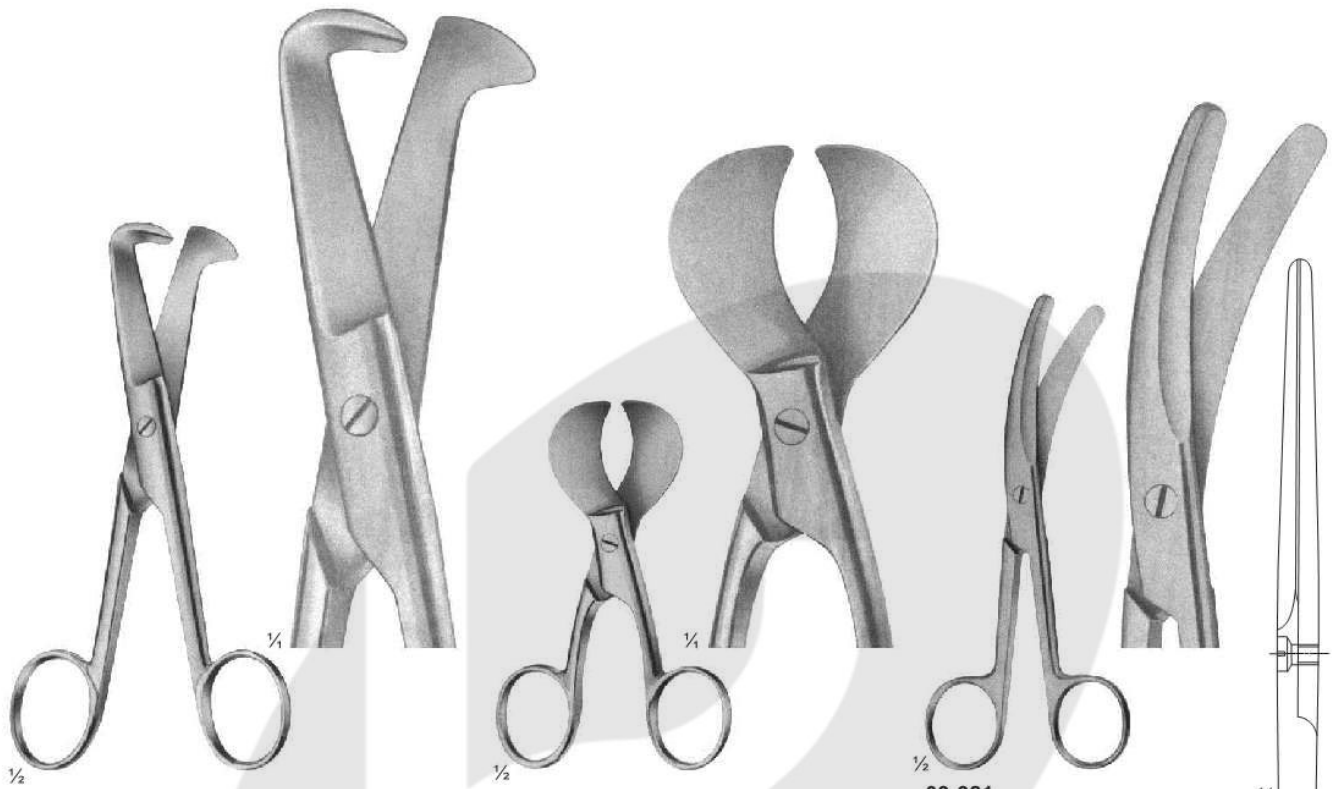

03-319
SCHUMACHER
 Umbilical Cord Scissors
 Size: 155 mm

03-320
 Umbilical Cord Scissors
 Size: 105 mm

03-321
 Umbilical Cord Scissors
 135 mm

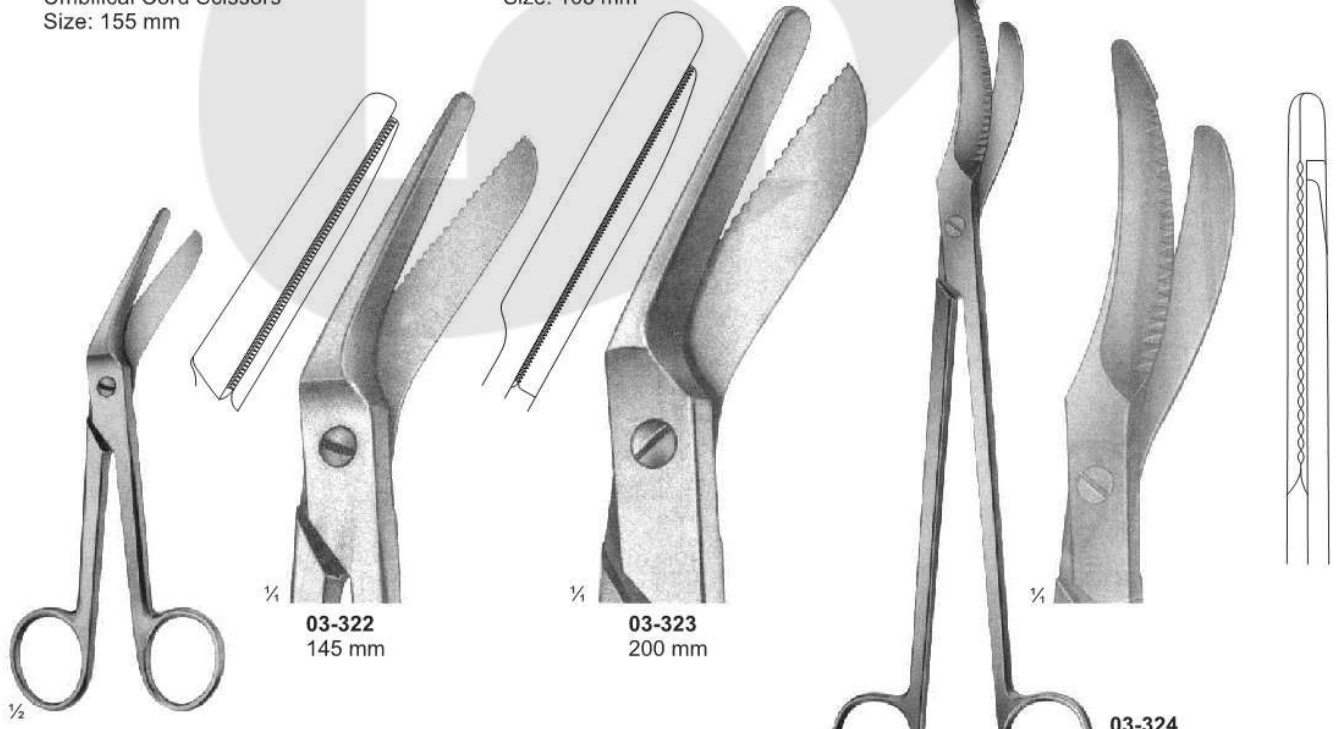

03-322 - 323
BRAUN-STADLER
 Episiotomy Scissors

03-322
 145 mm

03-323
 200 mm

03-324
DAMMSCHERE
 Episiotomy Scissors
 240 mm

Bowel Scissors, Cartilage Scissors



03-325
DAMMSCHERE
 Bowel Scissors
 Size: 210 mm

03-326
DAMMSCHERE
 Bowel Scissors
 Size: 210 mm

03-327
LLOYD-DAVIES
(GOLIGHER'S)
 Rectal Scissors
 Size: 255 mm

03-328
STELZNER
 Rectal Scissors
 Size: 310 mm

Ligature Scissors

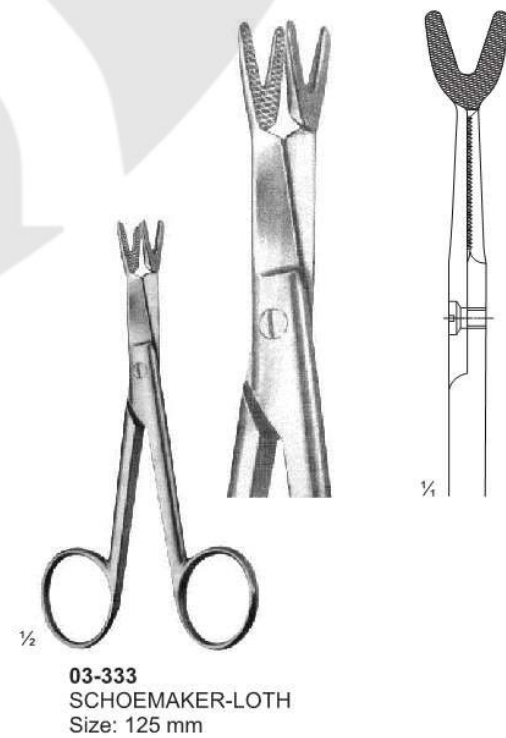
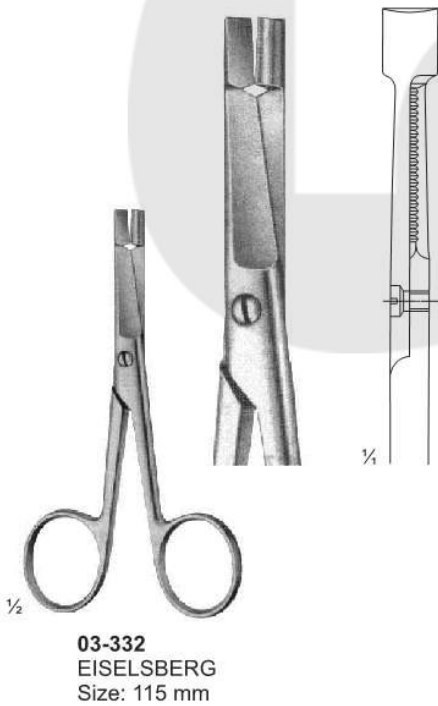
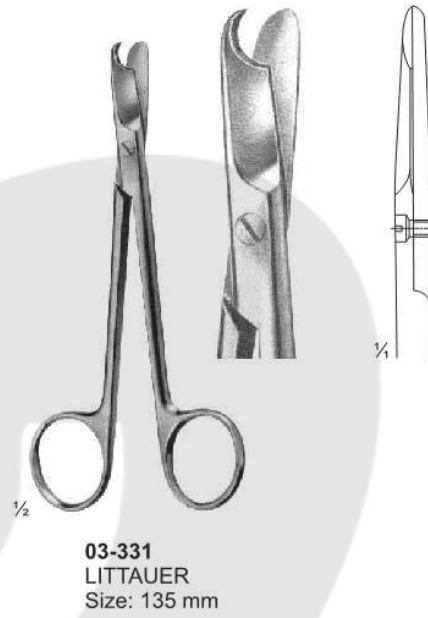

Wire and Plate Scissors

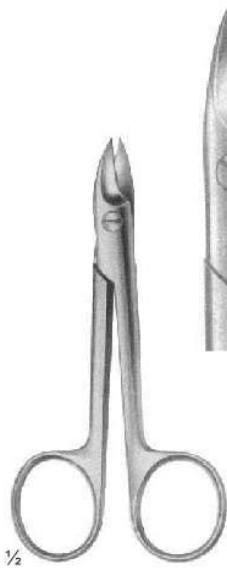

03-334 - 338
BEEBE
Size: 110 mm

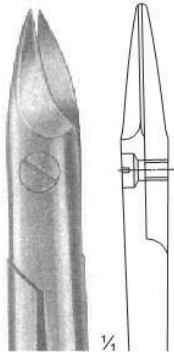

03-334

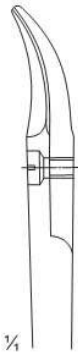

03-335

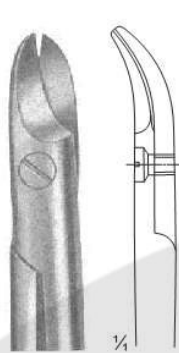

03-336
Broad Blades

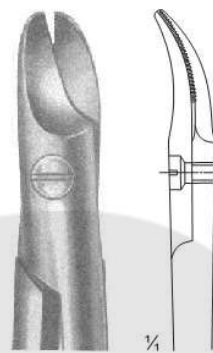

03-337
1 Blade Serrated

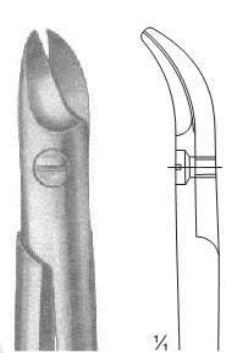

03-338
NAUJOKS
Strongly Curved

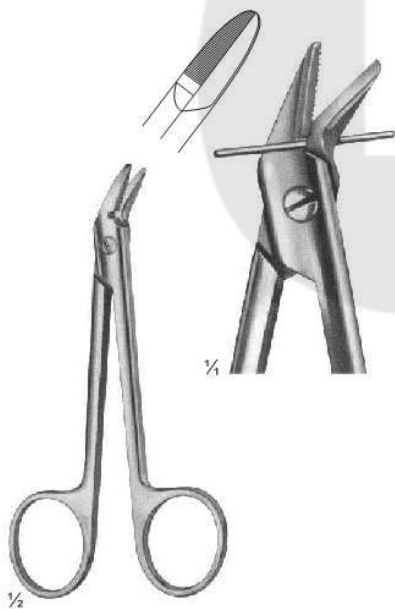

03-339
1 Blade Serrated
Size: 120 mm



03-340
STRACK
Size: 100 mm

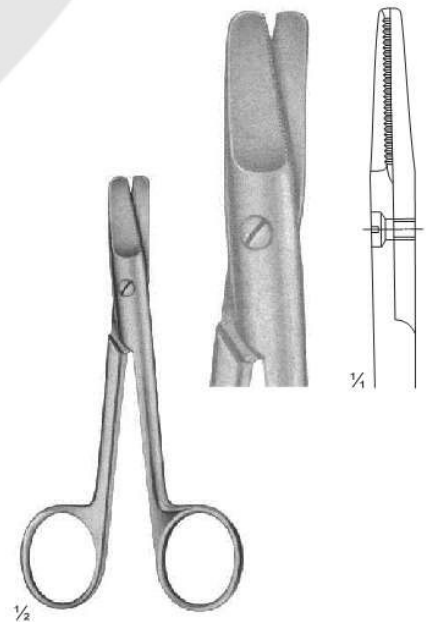

03-341
HARVEY
Size: 125 mm

Wire and Plate Scissors

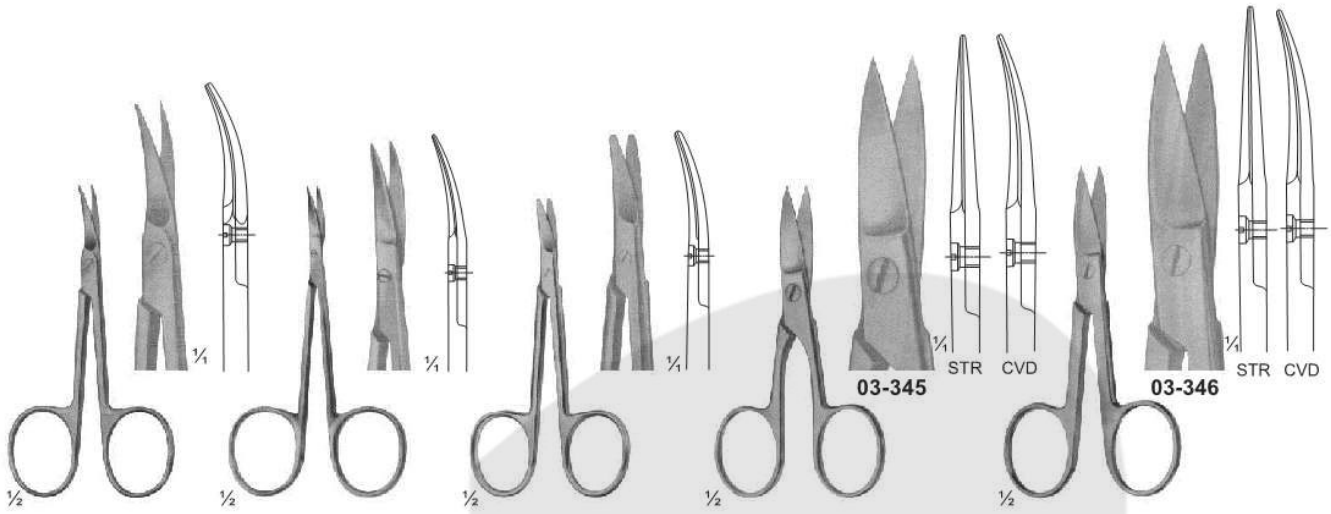

03-342
NAIL SCISSORS
Size: 90 mm

03-343
NAIL SCISSORS
Size: 90 mm

03-344
BABY NAIL SCISSORS
Size: 85 mm

03-345
NAIL SCISSORS
Size: 90 mm

03-346
NAIL SCISSORS
Size: 90 mm

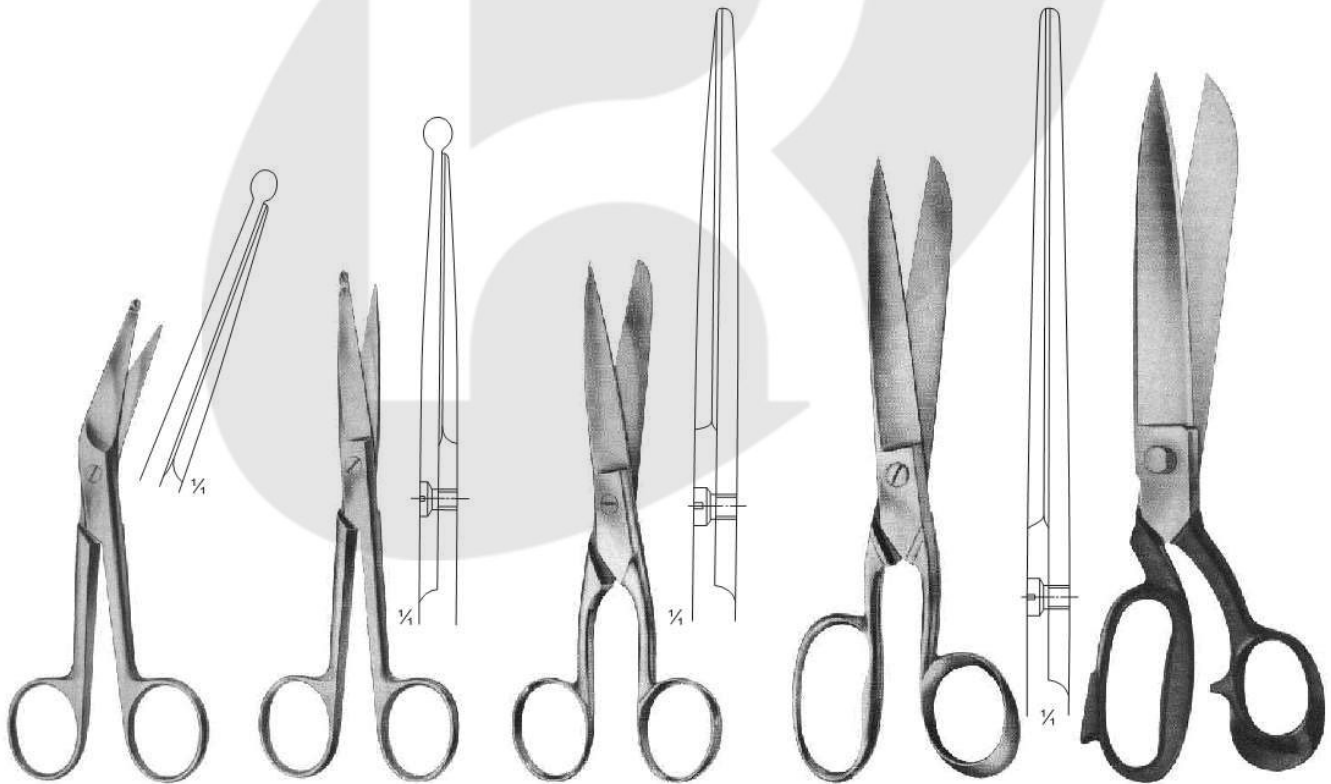

03-347
KNOWLES
Size: 140 mm

03-348
KNOWLES
Size: 145 mm

03-349
Size: 150 mm

03-350
SMITH
Size: 180 mm

03-351
Size: 310 mm

Bandage and Cloth Scissors

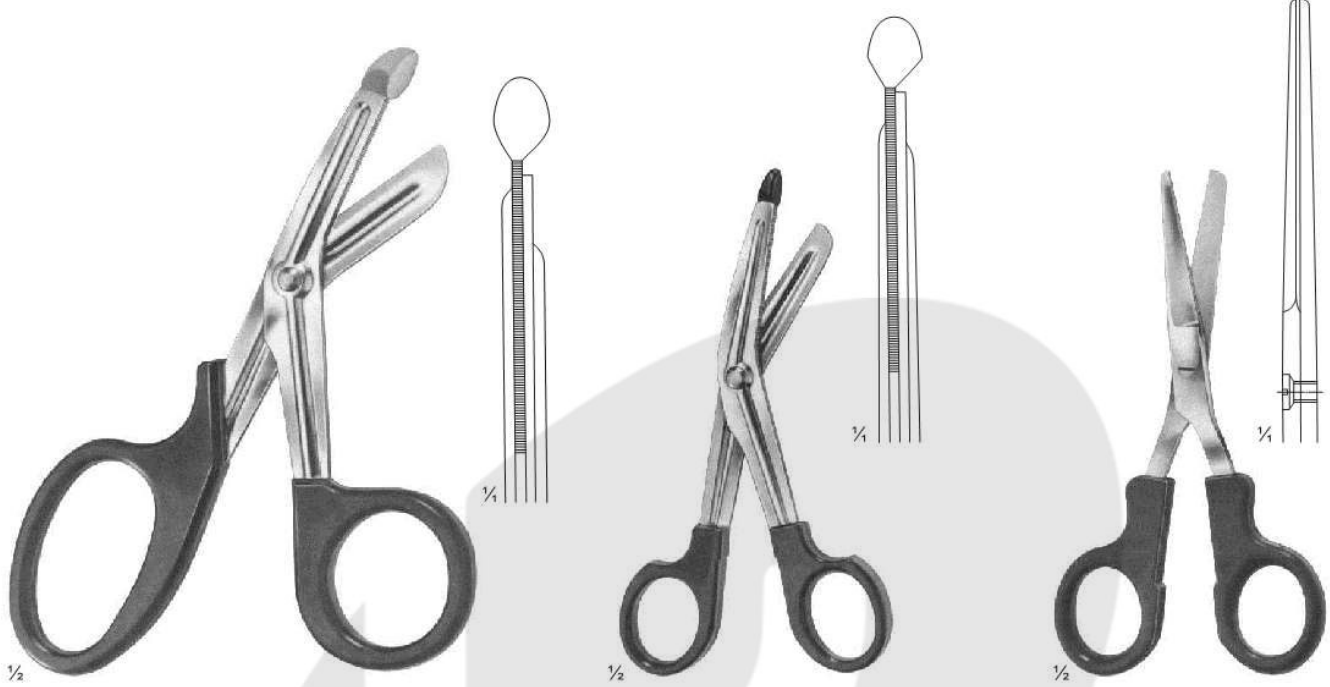

03-352
UNIVERSAL AND BANDAGE SCISSORS
180 mm

03-353
LISTER
Size: 145 mm

03-354
LISTER
Size: 145 mm

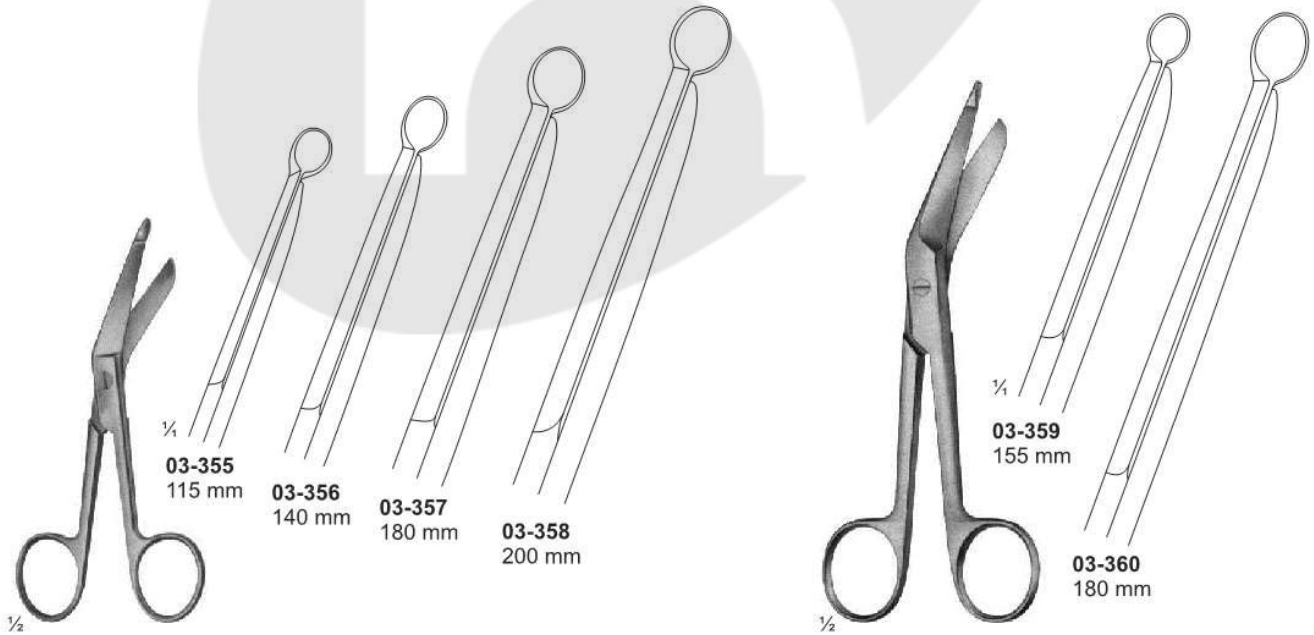

03-355 - 358
LISTER

03-359 - 360
LISTER

Bandage, Cloth and Plaster Scissors



03-361
CLOTH SCISSORS
205 mm

03-362
BRAUN-STADLER
225 mm

03-363
SEUTIN
230 mm

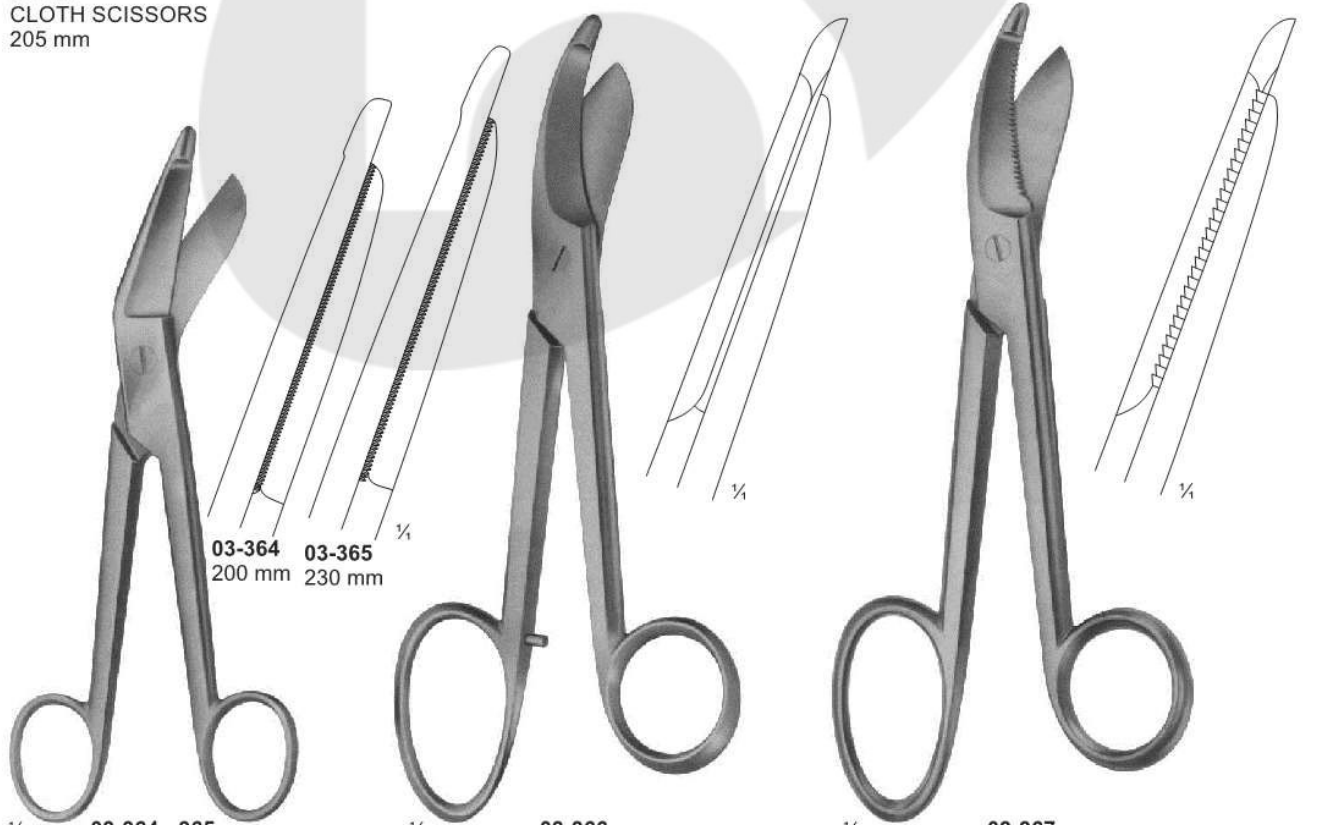

03-364 **03-365**
200 mm 230 mm

03-364 - 365
ESMARCH

03-366
BRUNS
235 mm

03-367
BRUNS
235 mm

Micro Forceps, Jeweler Types

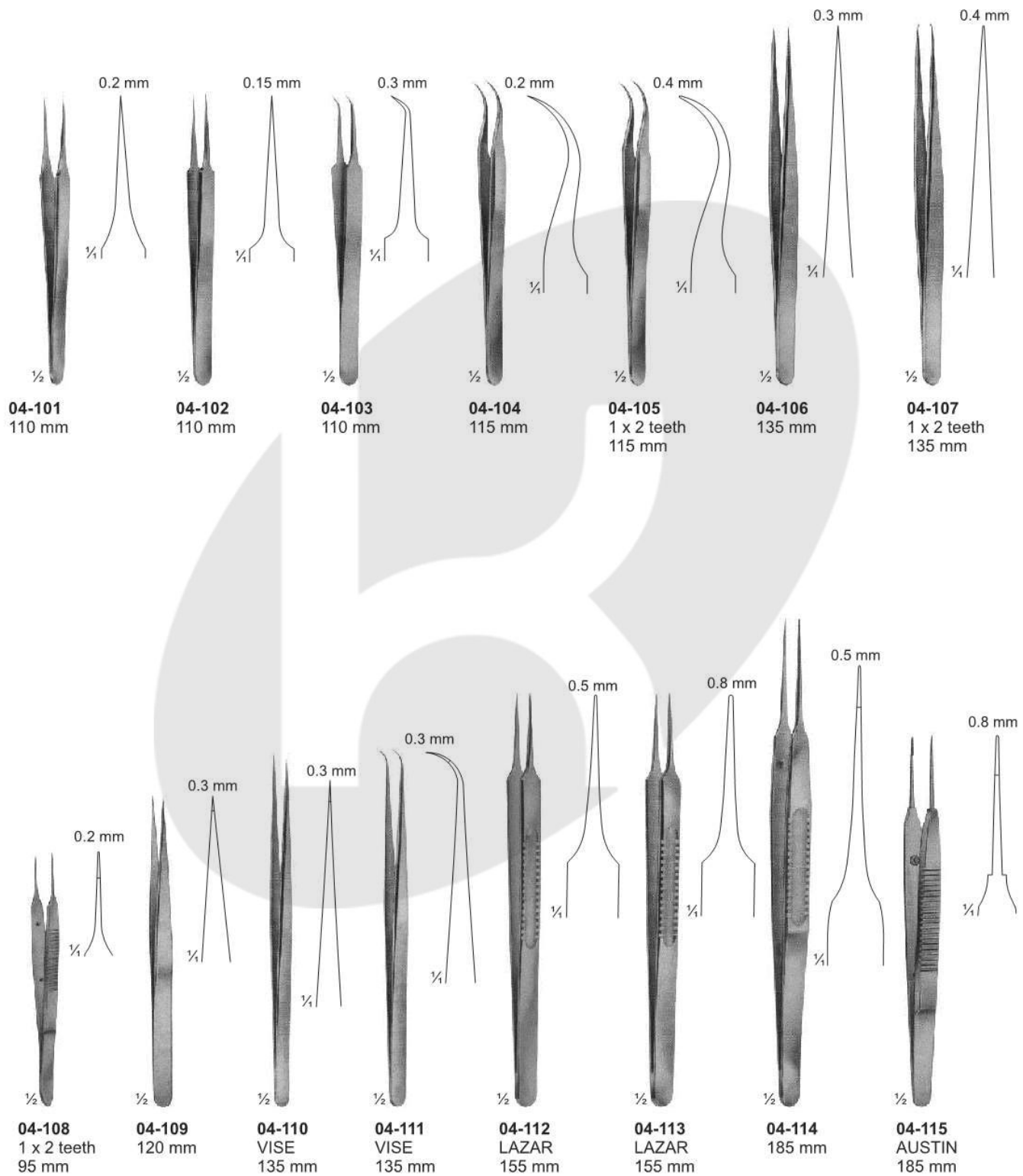

Ligature Forceps, Micro Forceps (Light Patterns)

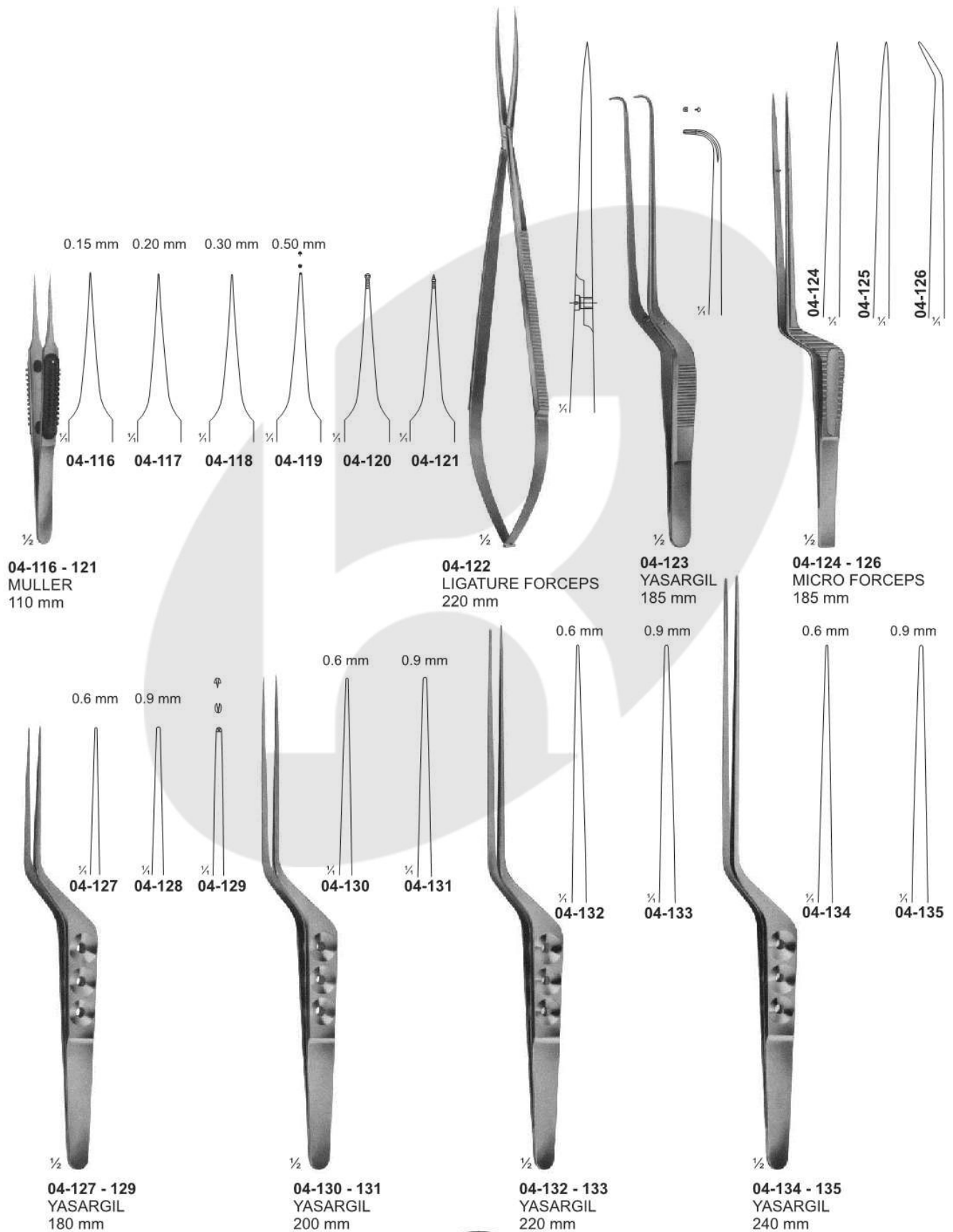

Forceps for Grasping Tissue, Tumors

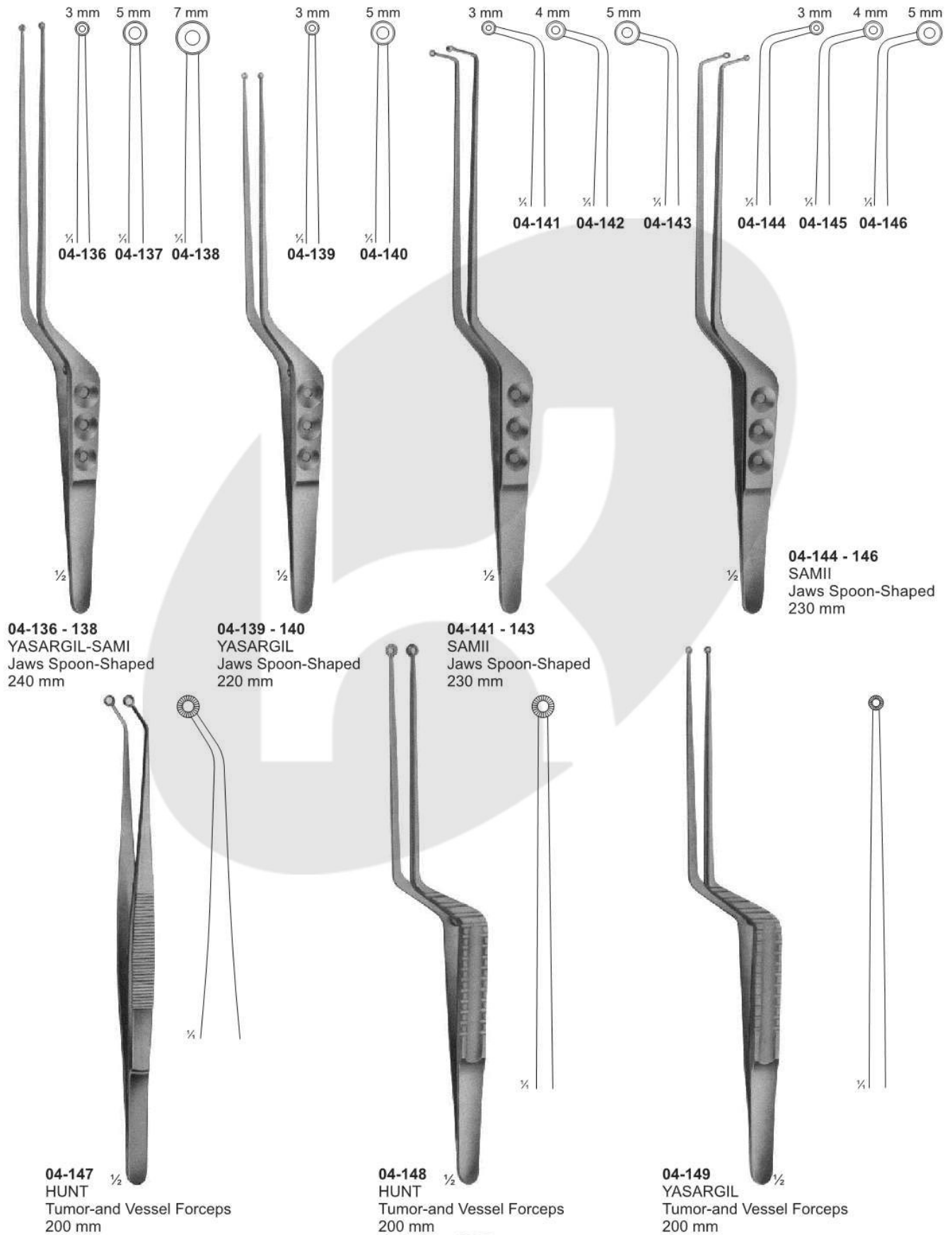

Delicate Dissecting, Microscopic, Sterilizing Forceps

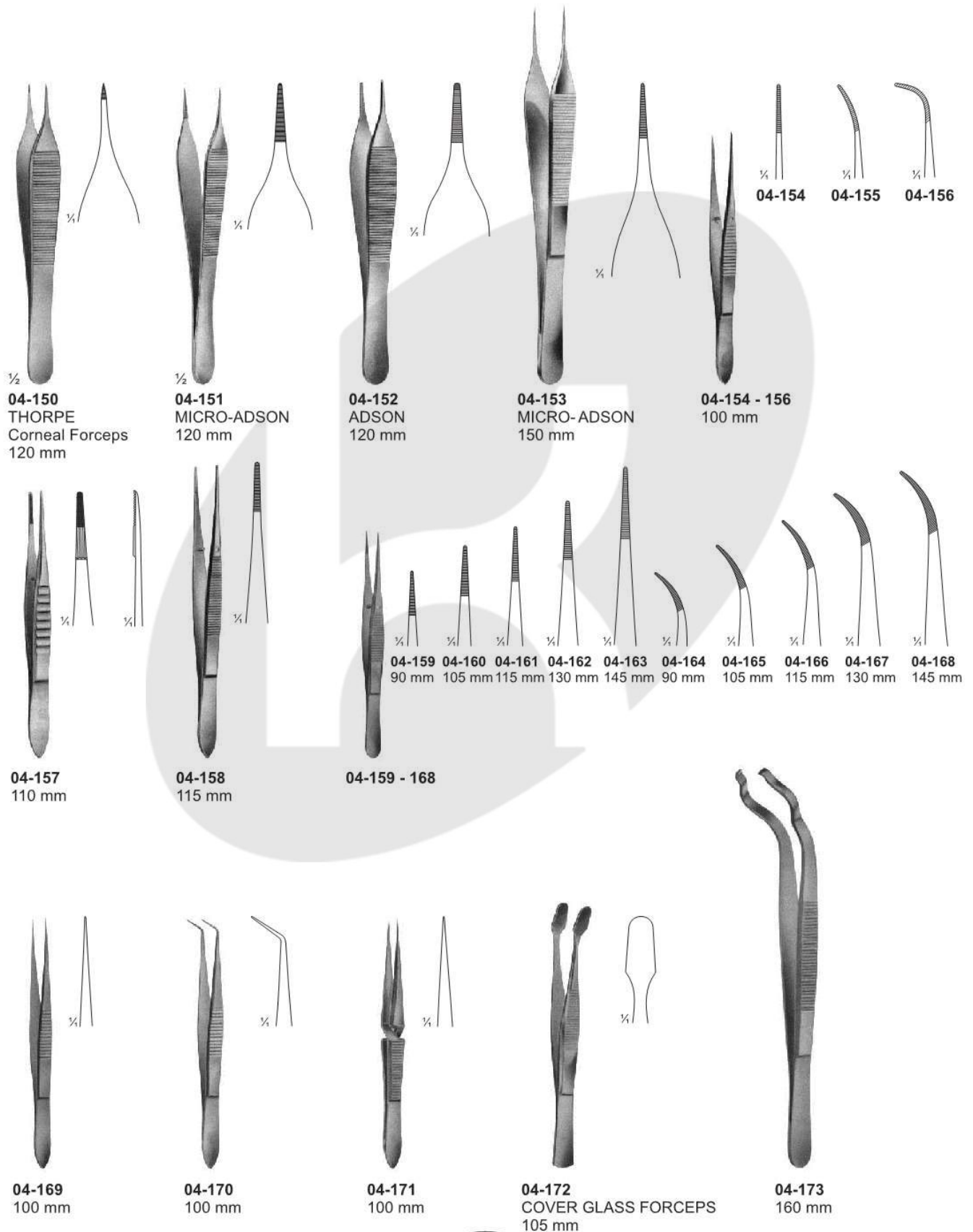

Delicate Dissecting Forceps



Dissecting Forceps



04-190 - 197
STANDARD

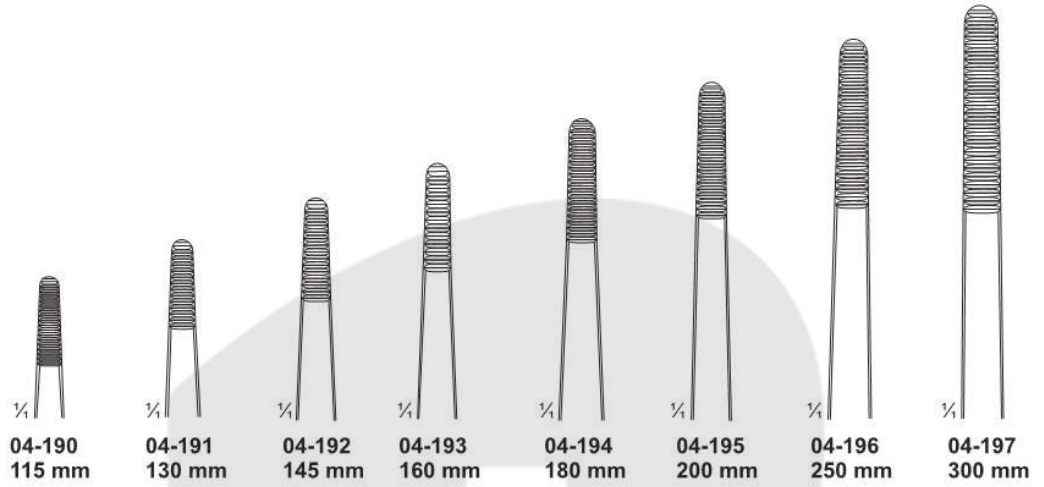

04-198 - 202
MEDIUM

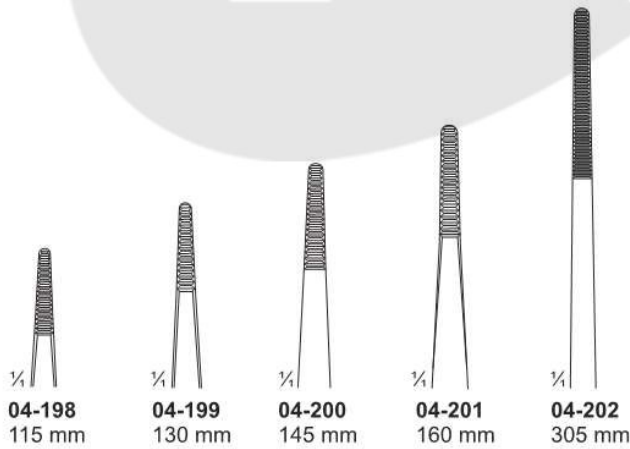

04-203 - 204
MEDIUM

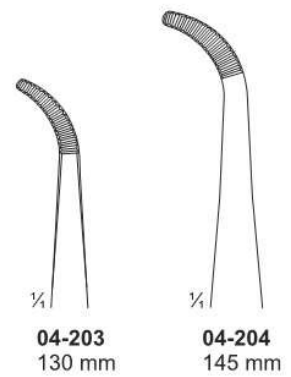

Dissecting Forceps



04-205 - 206



04-205
125 mm



04-206
155 mm



04-207 - 210

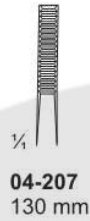

04-207
130 mm



04-208
150 mm



04-209
170 mm



04-210
200 mm



04-211
OCHSNER



04-212
FRICKE



04-213
BONNEY



Ultra-Light Forceps

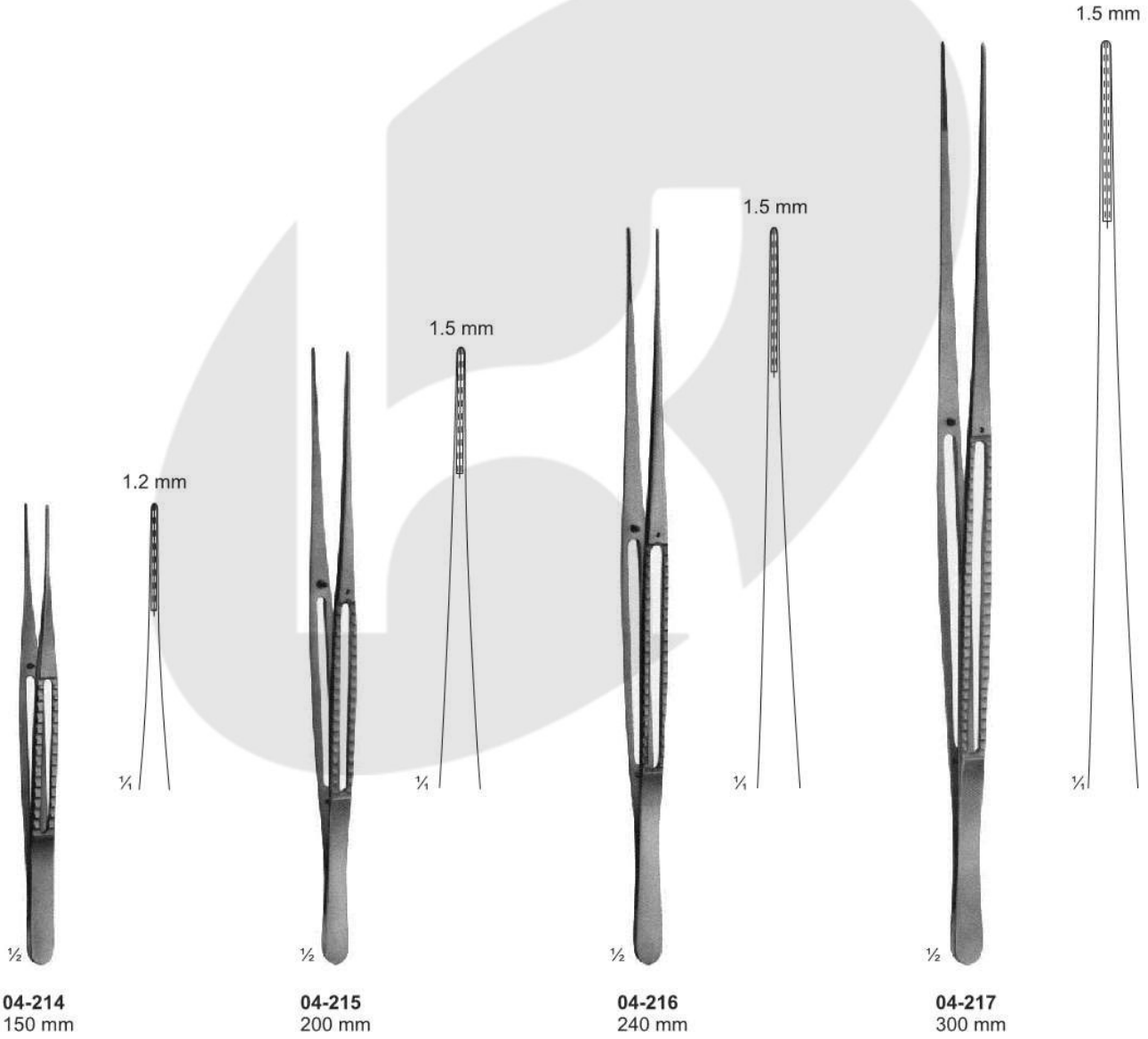

Forceps

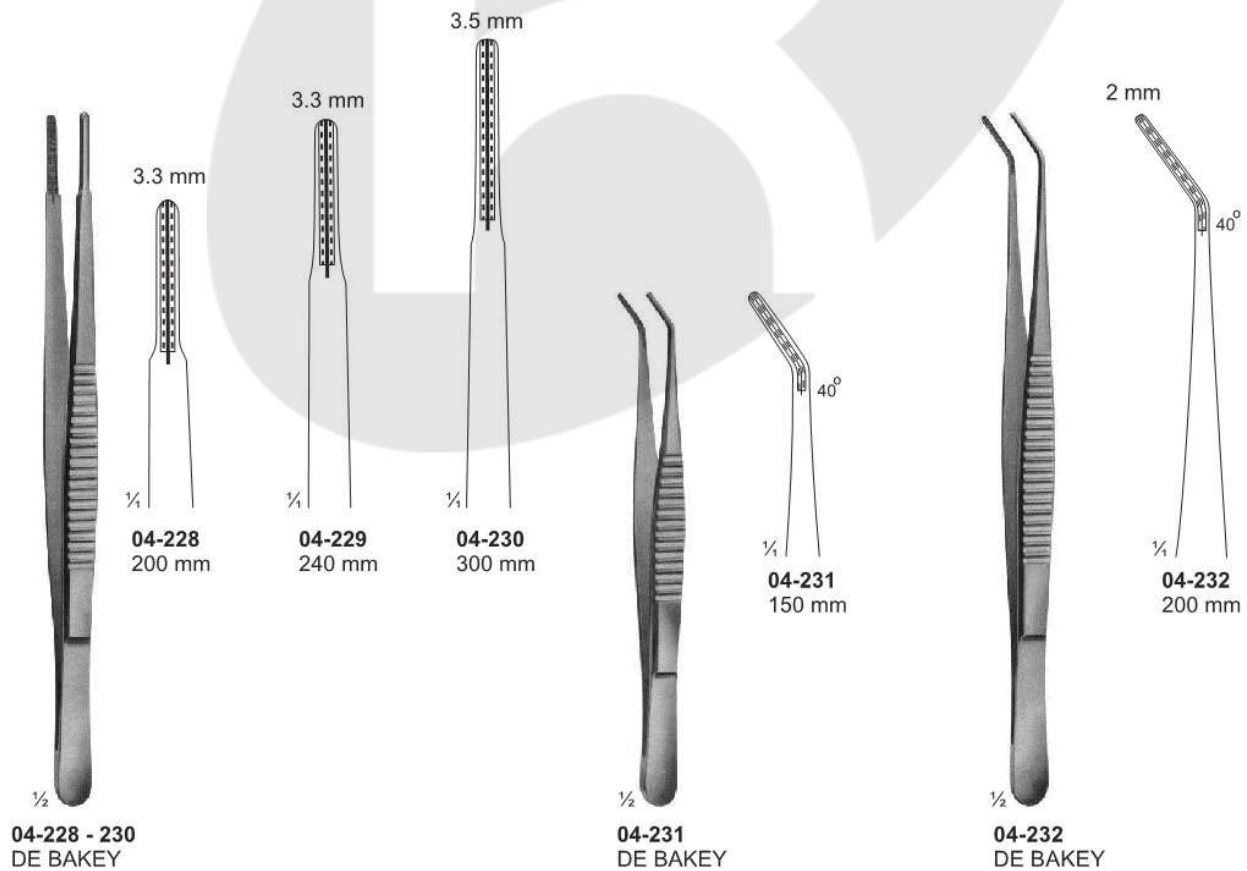
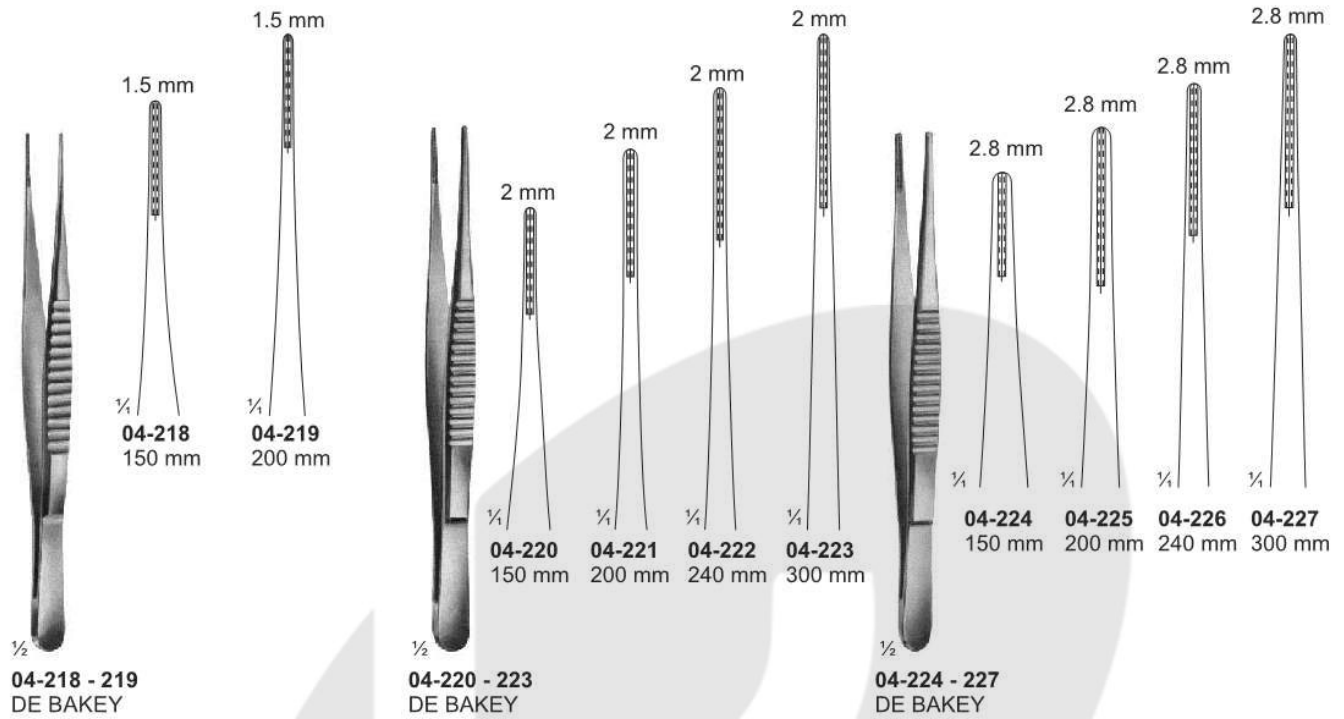

Forceps, Bayonet - Shaped



04-233
LUCAE
140 mm



04-234
LUCAE
1x2 teeth
140 mm

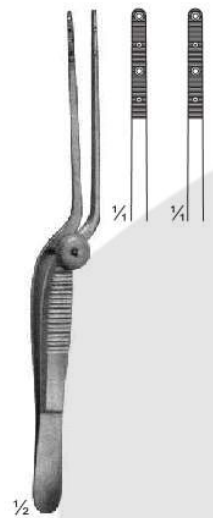

04-235
COTTLE
Forceps with
jaws toothed
and serrated
140 mm



04-236
JANSEN
160 mm

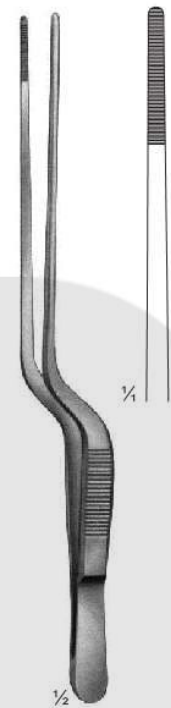

04-237
GRUENWALD
200 mm

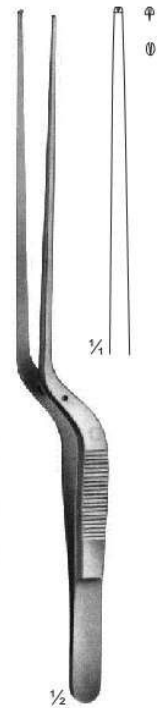

04-238
1x2 teeth
200 mm



04-239
TROELTSCH
100 mm

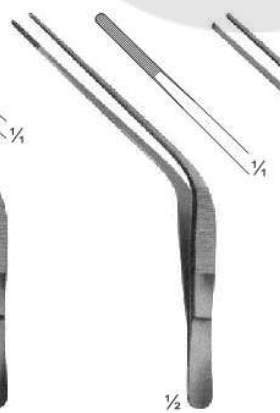

04-240
TROELTSCH
115 mm

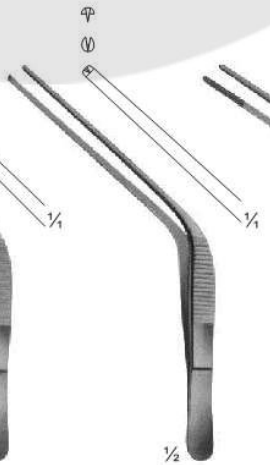

04-241
TROELTSCH
1X2 teeth
115 mm

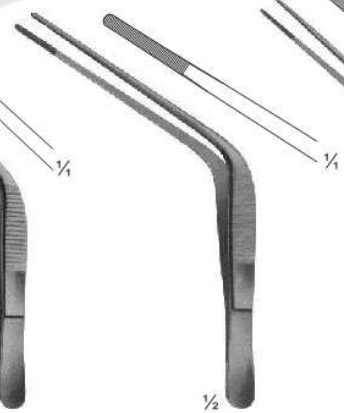

04-242
WILDE
115 mm

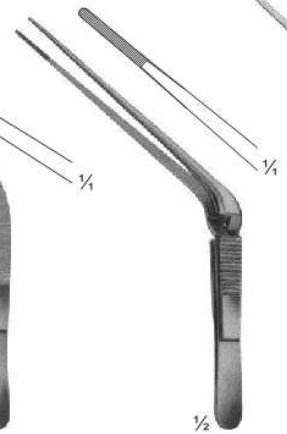

04-243
TROELTSCH
Cross action
120 mm

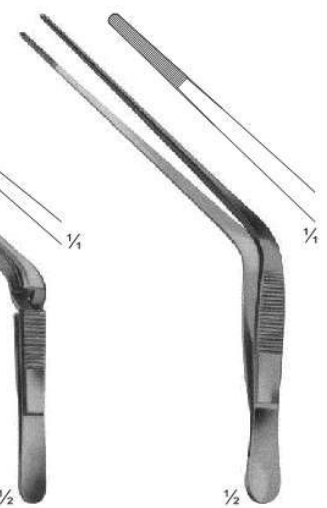

04-244
TROELTSCH
140 mm

Delicate Tissue Forceps

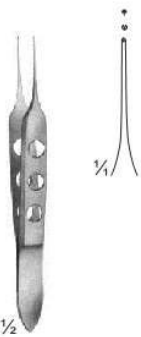

04-245
BISHOP-HARMON
85 mm

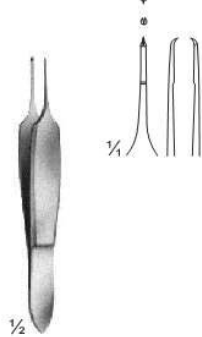

04-246
ST. MARTIN
80 mm

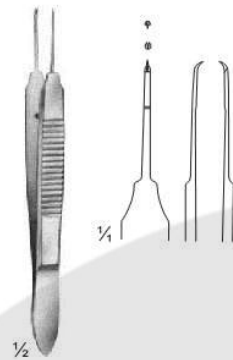

04-247
CASTROVIEJO
teeth 0.9 mm
100 mm

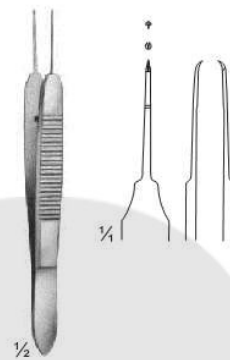

04-248
CASTROVIEJO
teeth 0.5 mm
100 mm

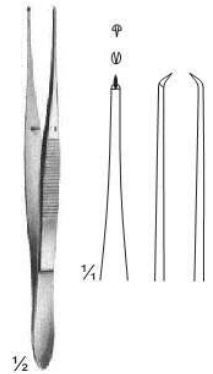

04-249
ELSCHING
110 mm

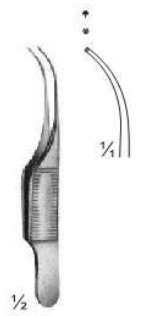

04-250
GILL
75 mm

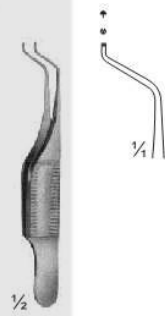

04-251
GILL - HESS
75 mm

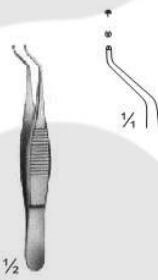

04-252
HESS
70 mm

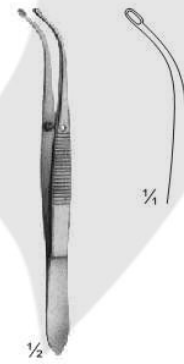

04-253
ARRUGA
100 mm

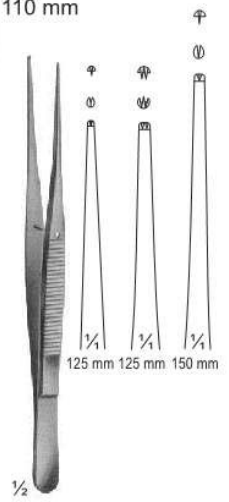

04-254
SEMKEN

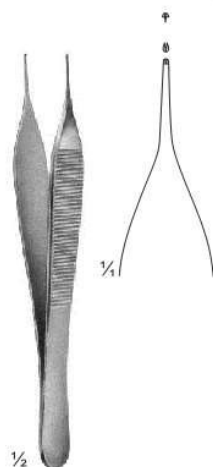

04-255
MICRO-ADSON
120 mm

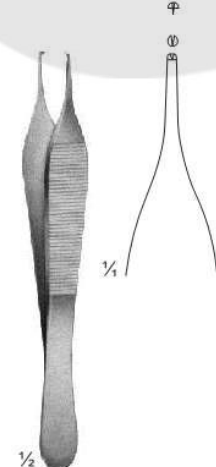

04-256
ADSON
120 mm

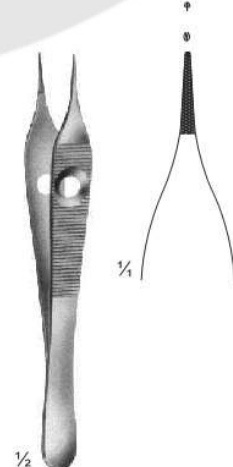

04-257
ADSON
120 mm



04-258
ADSON
120 mm

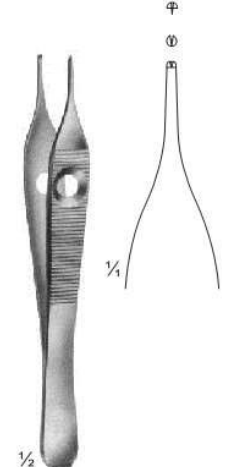

04-259
ADSON
150 mm

Tissue Forceps

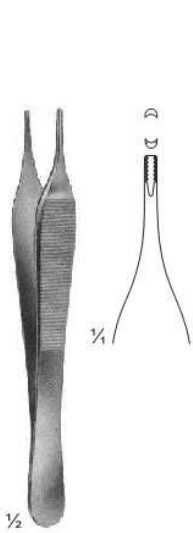

**04-260
ADSON - BROWN
Non-traumatic
120 mm**

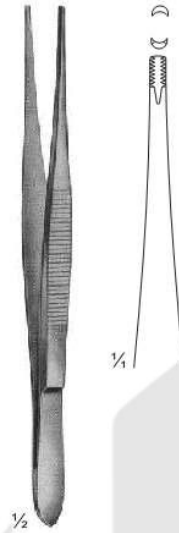

**04-261
BROWN
120 mm**

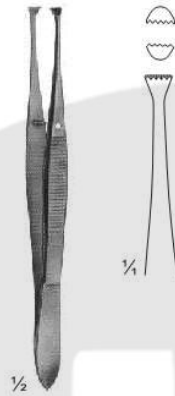

**04-262
GRAEFE
110 mm**

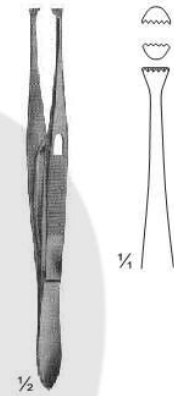

**04-263
GRAEFE
With Catch
110 mm**

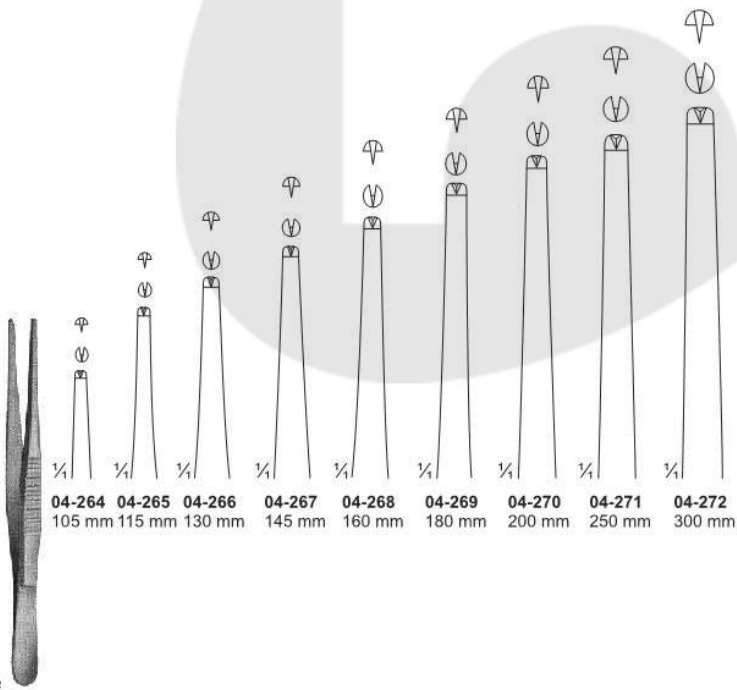

**04-264 - 272
STANDARD**

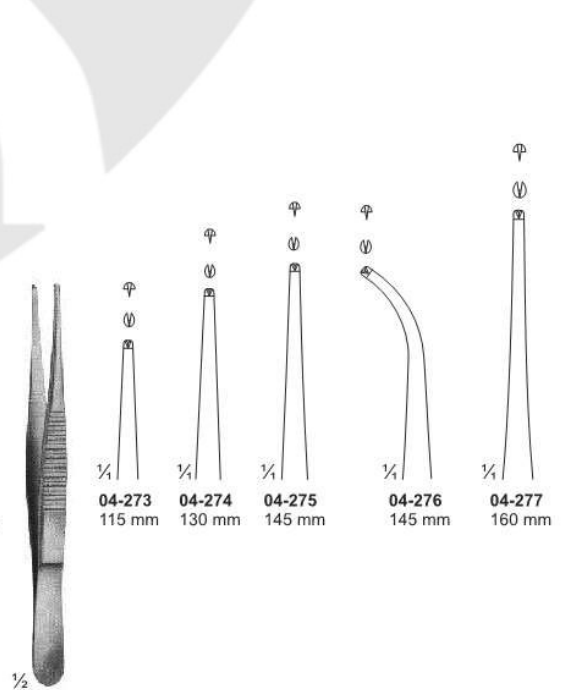

**04-273 - 277
GRAEFE
110 mm**

Tissue Forceps

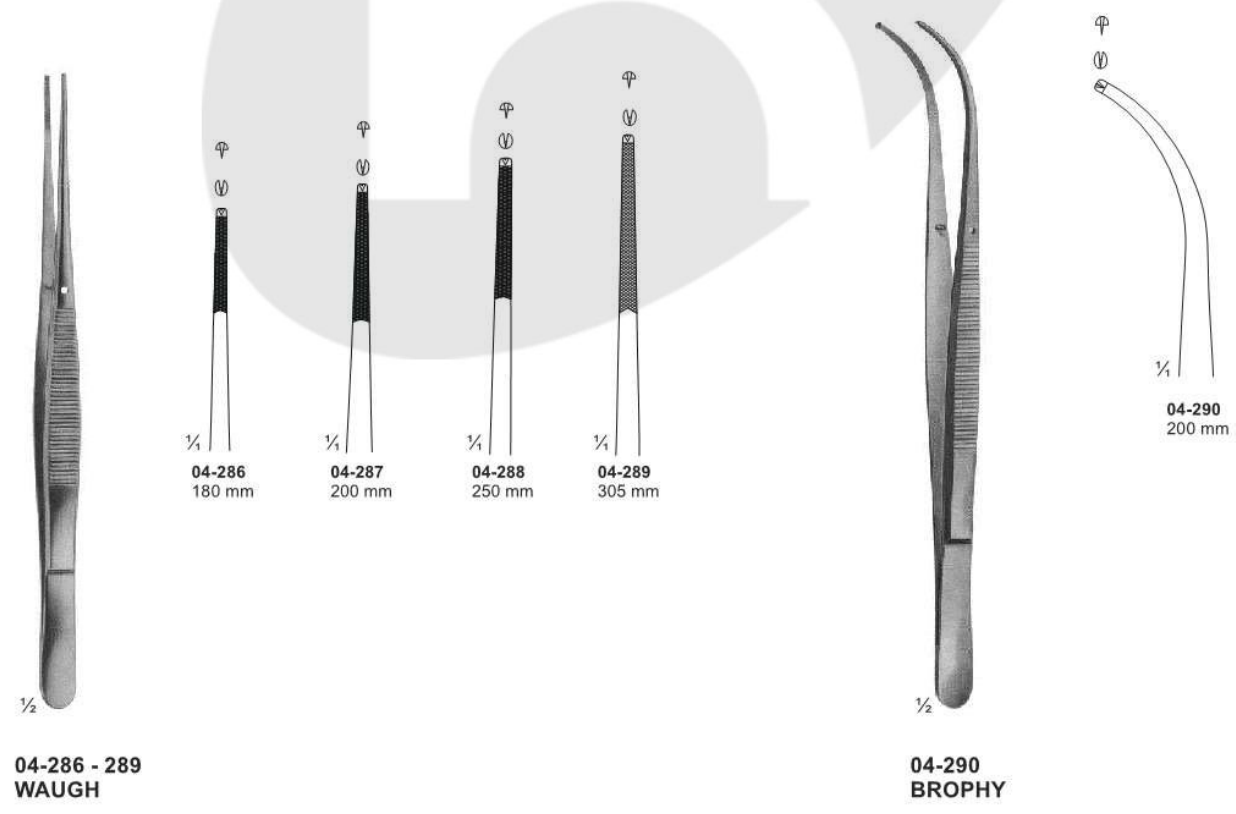
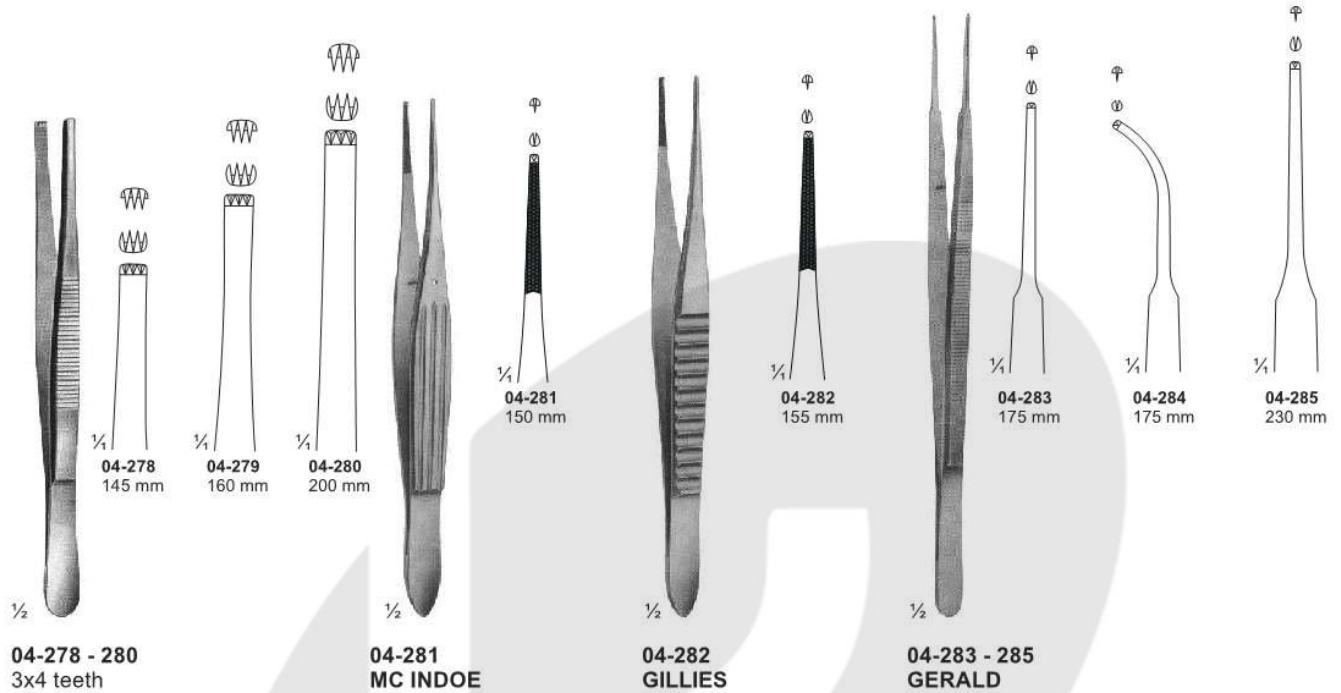

Tissue Forceps, Lung Dissecting Forceps



Splinter and Cilia Forceps



Sponge and Dressing Forceps

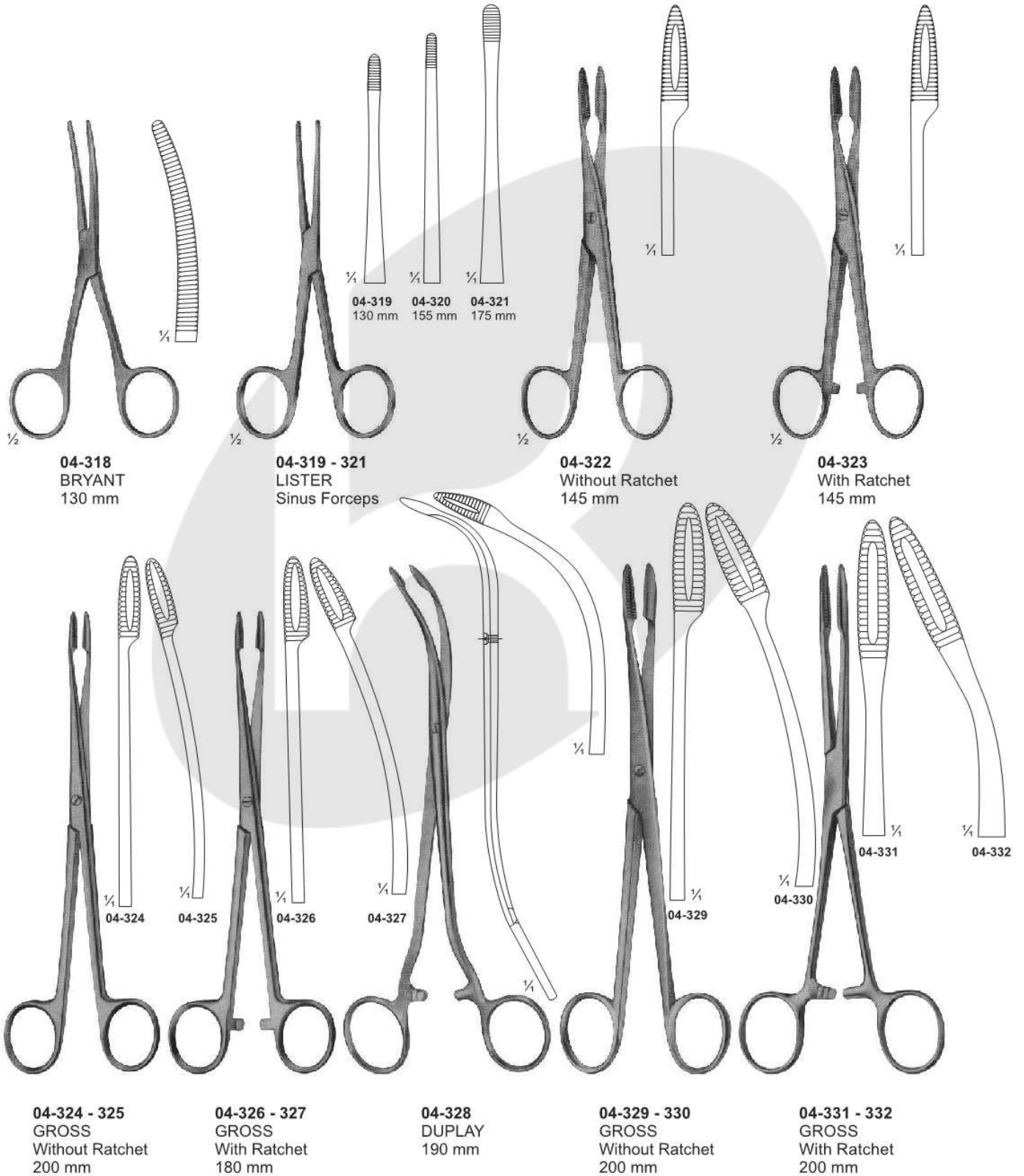

Sponge and Dressing Forceps



04-333 - 334
AESCULAP
220 mm

04-335 - 336
MAIER
Without Ratchet
265 mm

04-337 - 338
MAIER
With Ratchet
265 mm

Sponge and Dressing Forceps

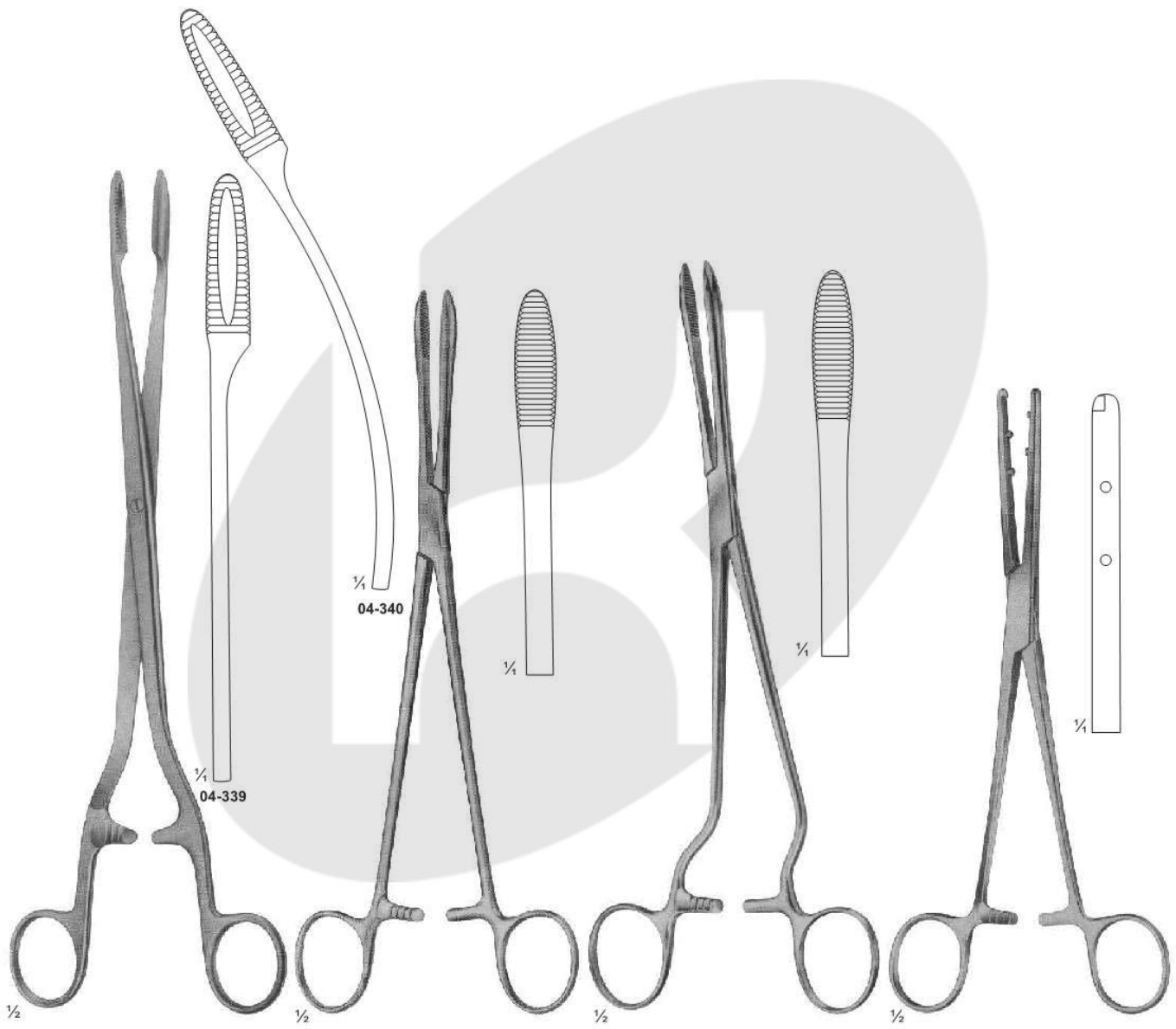

04-339 - 340
SIMS-MAIER
280 mm

04-341
COLLIN
240 mm

04-342
CHERON
Handles Laterally Angled
240 mm

04-343
EMMET
210 mm

Dressing, Sponge holding, Organ and Tissue Grasping Forceps

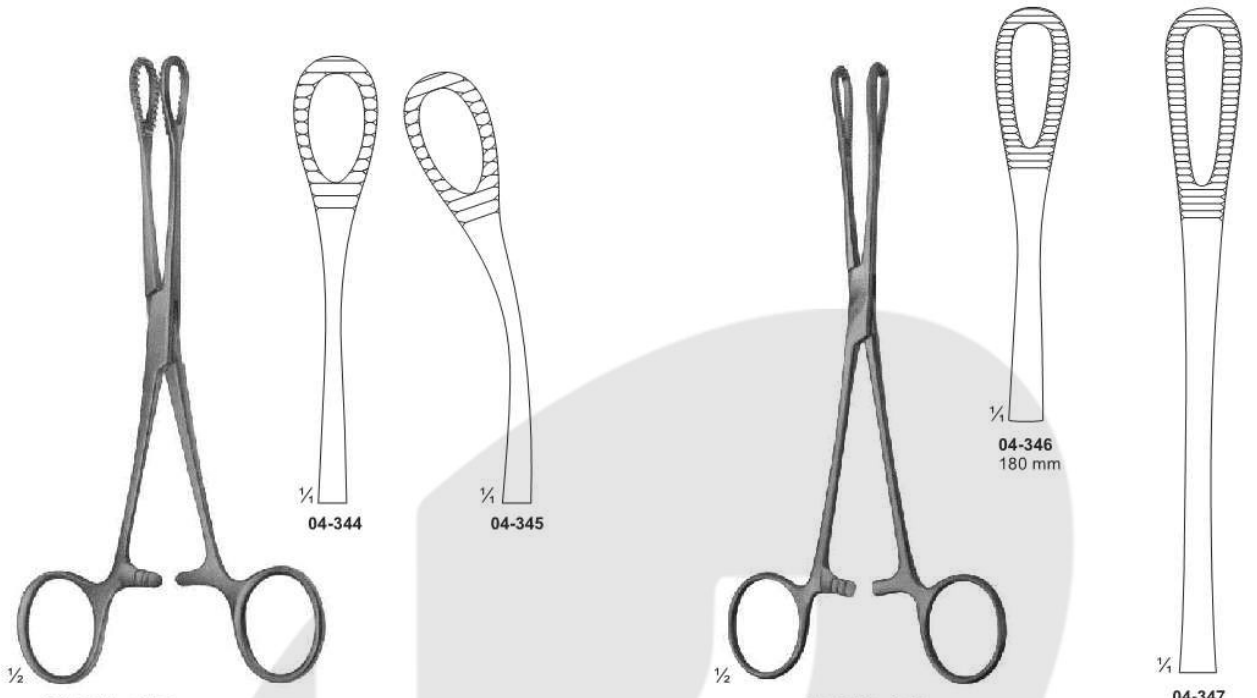

04-344 - 345
FOERSTER-BALLENGER
180 mm

04-346 - 347
RAMPLEY

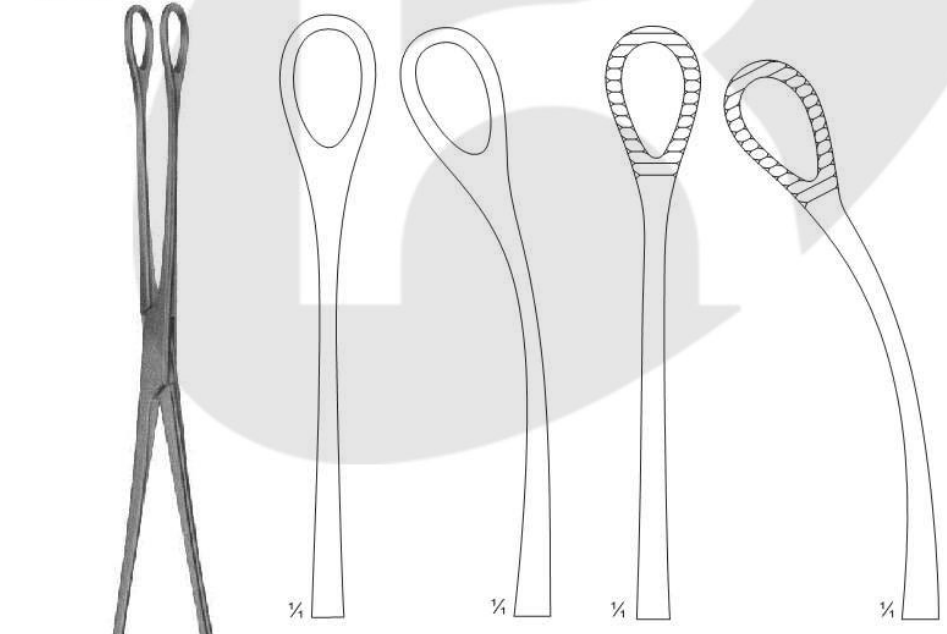

04-348 - 351
FOERSTER-BALLENGER
240 mm

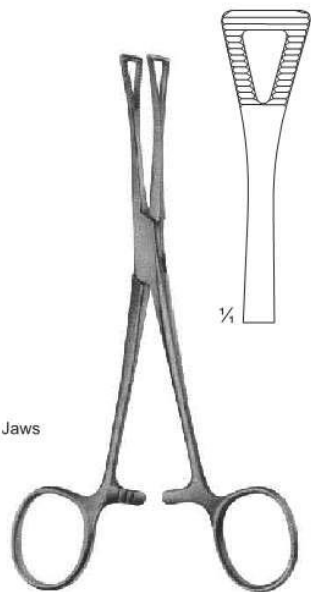

04-352
PENNINGTON
155 mm

Dressing, Sponge holding, Organ and Tissue Grasping Forceps

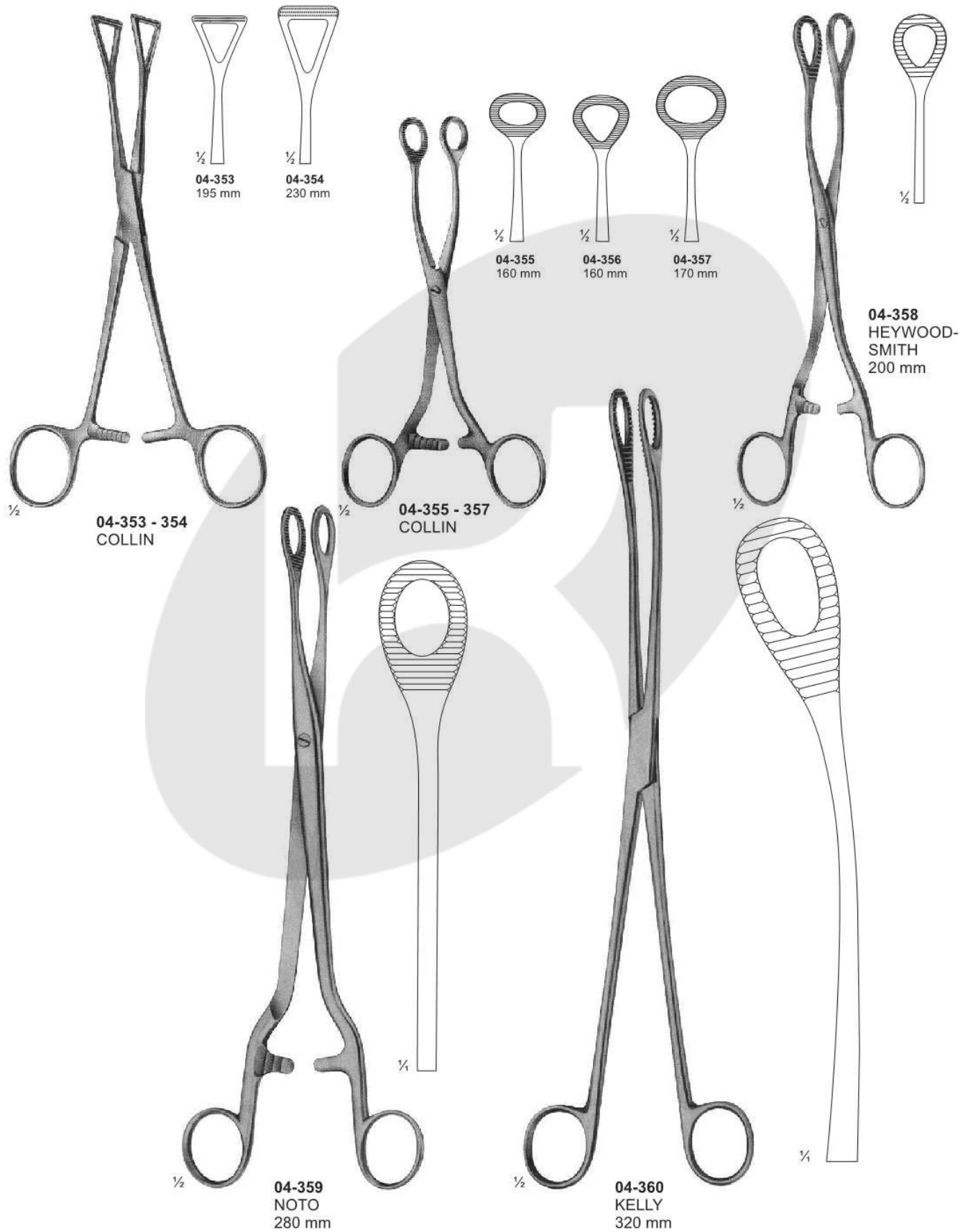

Tendon Seizing Forceps

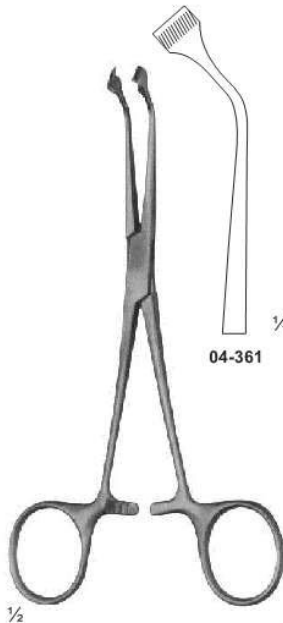

04-361

04-362

04-361 - 362
HERZ
155 mm



04-363

04-363
JACKSON
4 x 5 teeth
150 mm

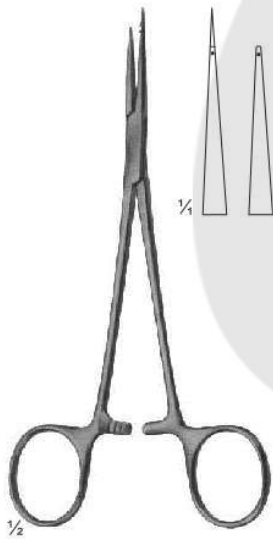

04-364
150 mm

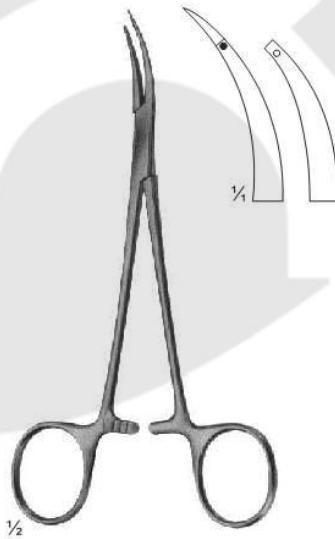

04-365
150 mm



04-366
120 mm

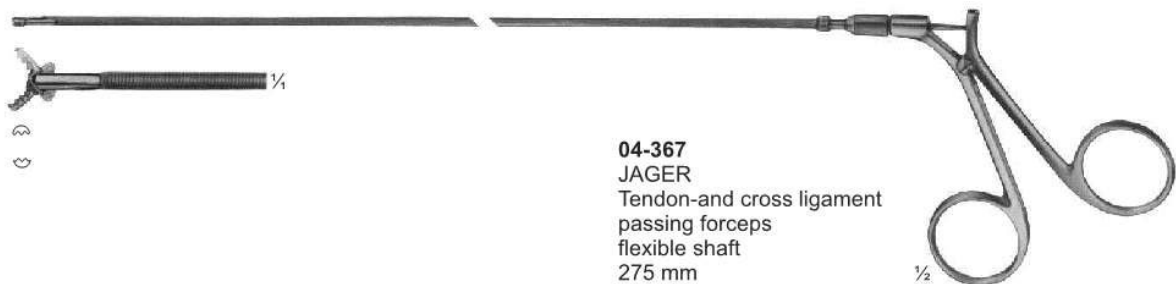

04-367
JAGER
Tendon and cross ligament
passing forceps
flexible shaft
275 mm

Artery Traction - and Tissue Grasping Forceps

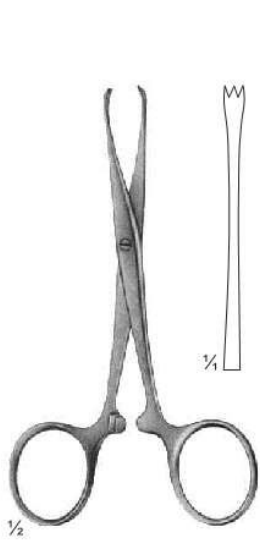

04-368
CHAPUT
 2 x 3 teeth
 125 mm

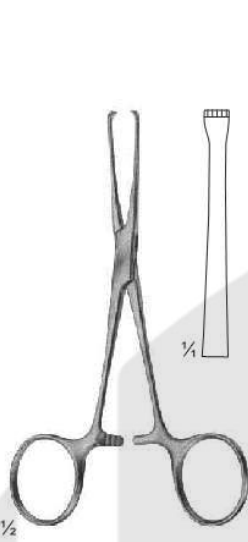

04-369
BABY-ALLIS
 4 x 5 teeth
 130 mm

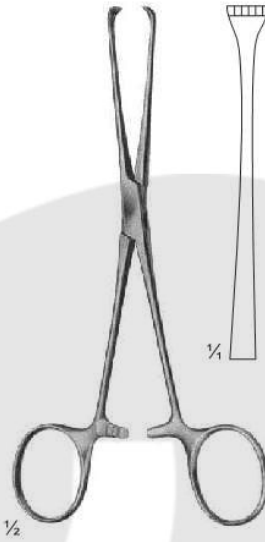

04-370
BOYS-ALLIS
 5 x 6 teeth
 155 mm

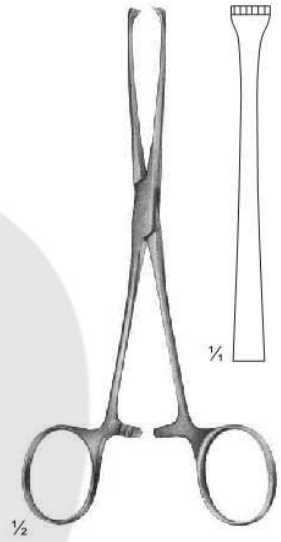

04-371
ALLIS
 5 x 6 teeth
 155 mm

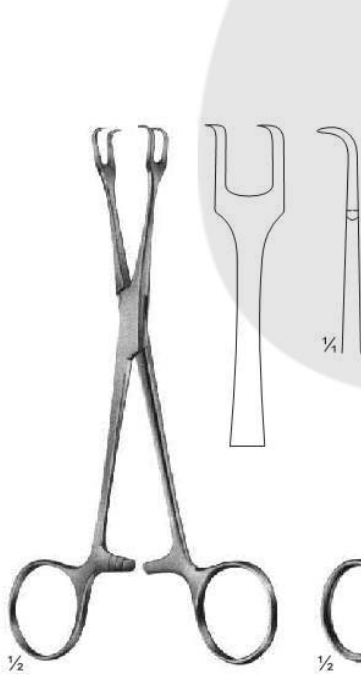

04-372
LAHEY
 135 mm

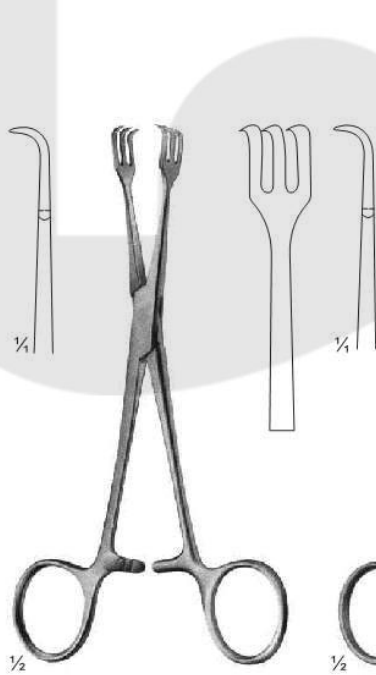

04-373
LAHEY
 135 mm

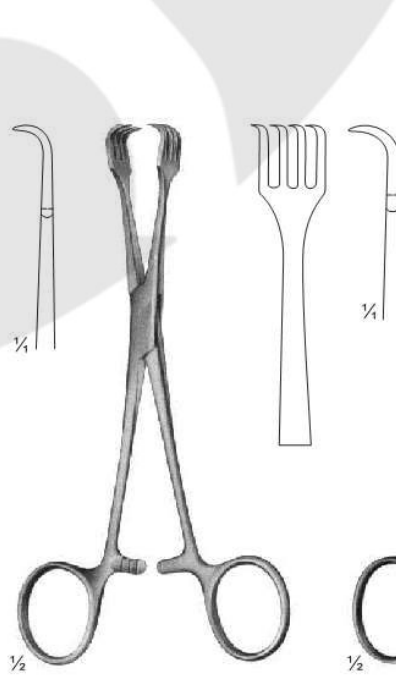

04-374
BRAUN
 155 mm

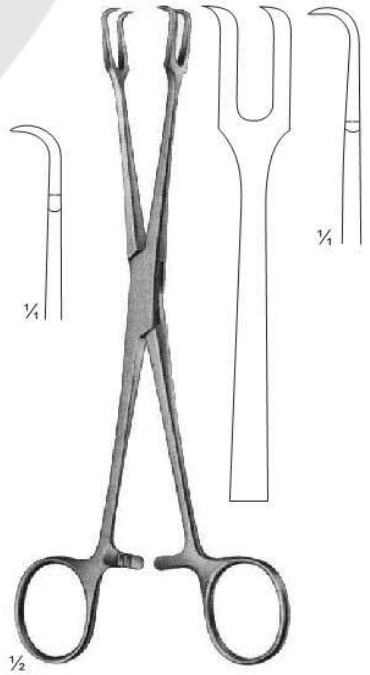

04-375
MUSEUX
 200 mm

Organ - and Tissue Grasping Forceps



04-376
AESCULAP
260 mm

04-377
PRATT
270 mm

04-378
TIEMANN
Bullet forceps
220 mm

04-379
SCHRODER
250 mm

Towel Clamps

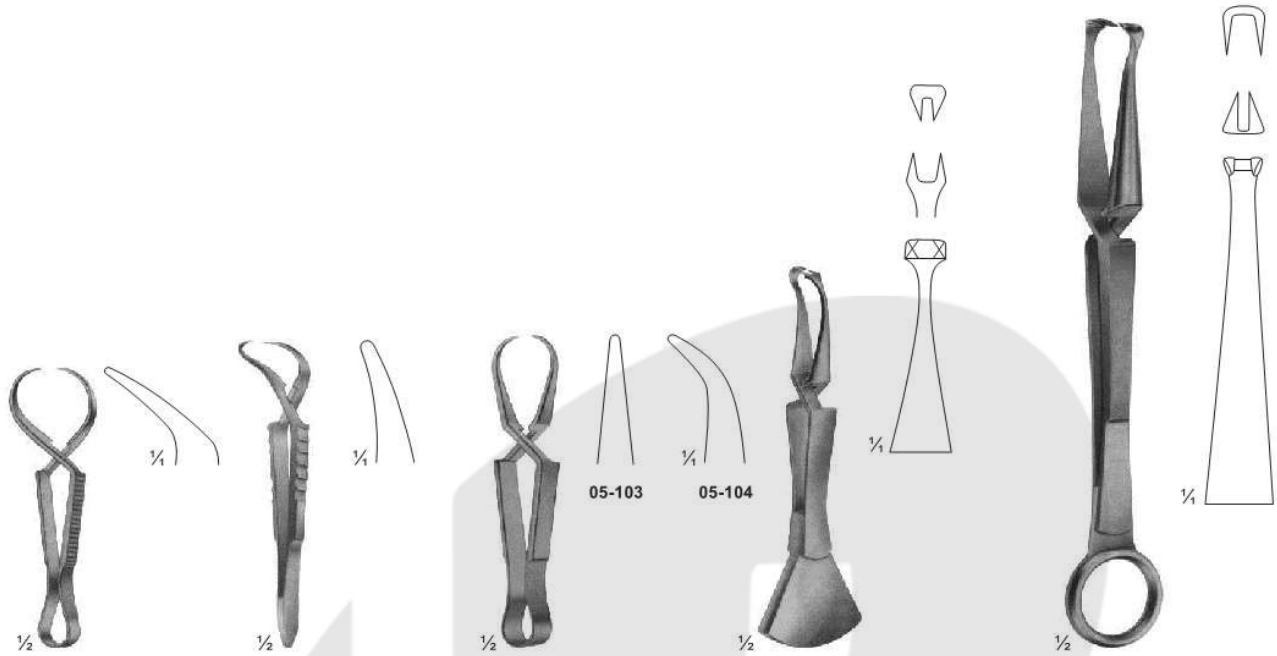

05-101
JONES
85 mm

05-102
ENGL. MOD.
85 mm

05-103 - 104
SCHAEDEL
85 mm

05-105
DOYEN
110 mm

05-106
DOYEN
180 mm

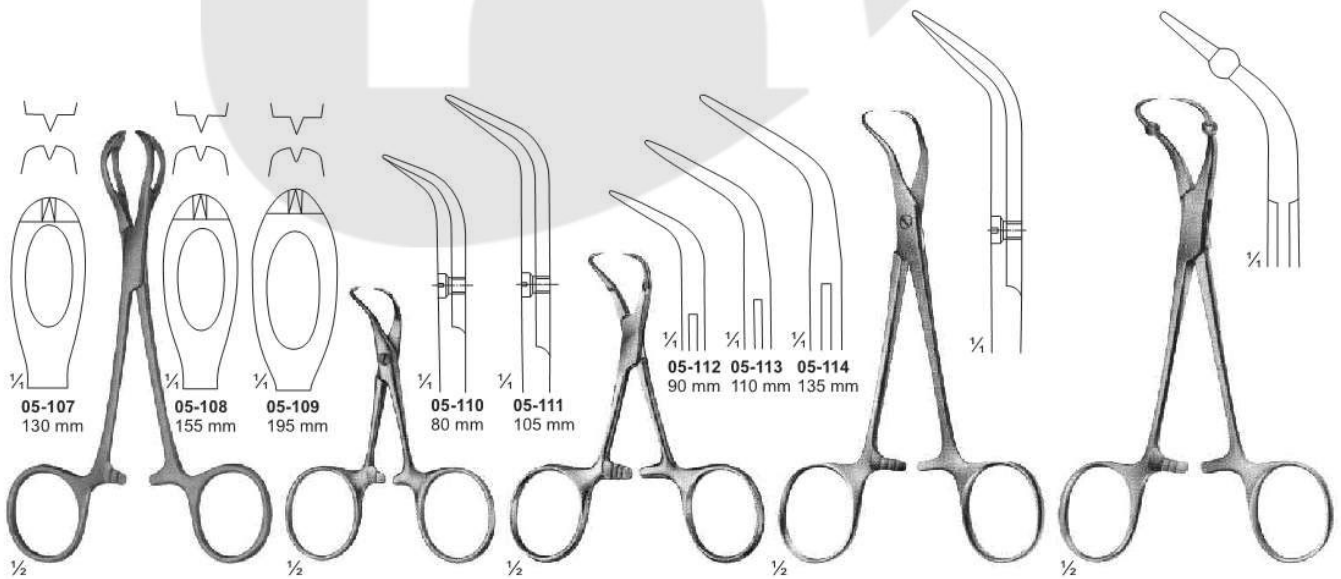

05-107
130 mm

05-108
155 mm

05-109
195 mm

05-110
80 mm

05-111
105 mm

05-112 05-113 05-114
90 mm 110 mm 135 mm

05-107 - 109
LANE

05-110 - 111
BACKHAUS

05-112 - 114
BACKHAUS

05-115
BACKHAUS-KOCHER
135 mm

05-116
ROEDER
135 mm

Towel Clamps

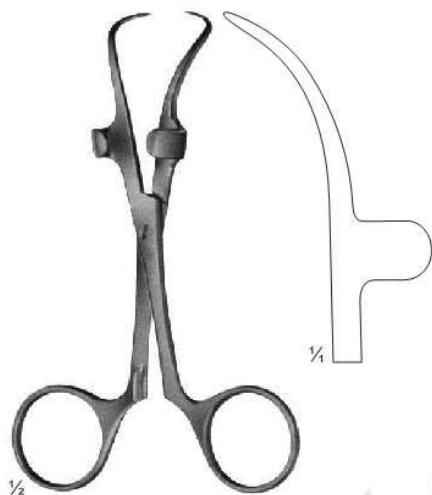

05-117
ROBIN
 with holders for tubing
 up to 13 mm
 135 mm

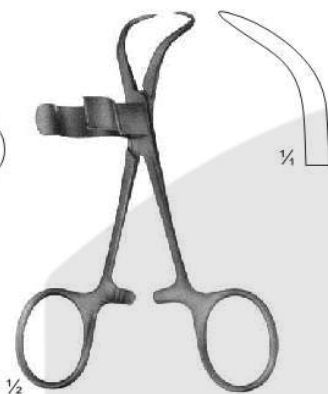

05-118
 with clip for tubing
 up to 15 mm
 110 mm

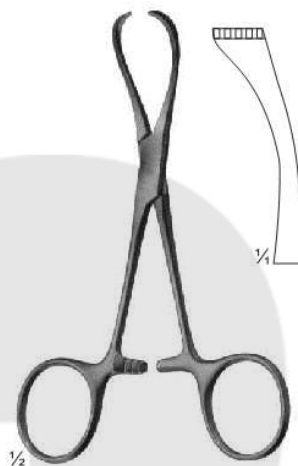

05-119
LORNA
 non perforating
 130 mm

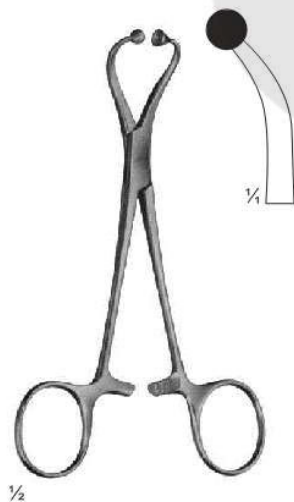

05-120
 for paper cloths
 140 mm



05-121
BUNT
 105 mm



05-122
MAYO
 140 mm

Muller Vessel Clips and Bulldog Clamps

Closing force

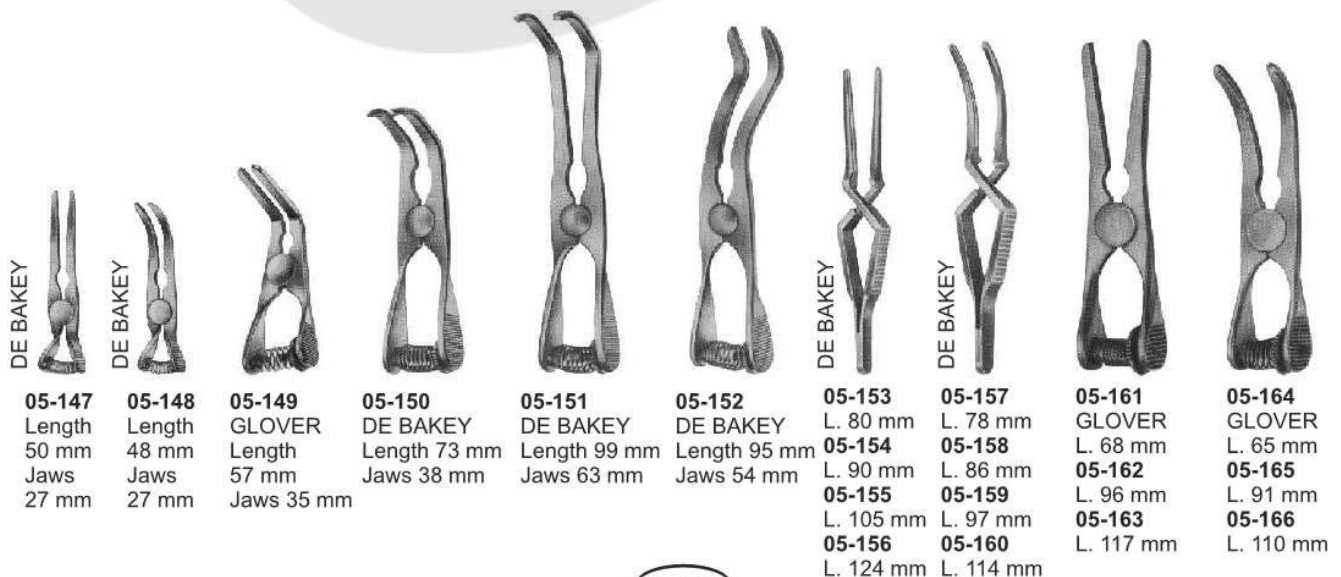
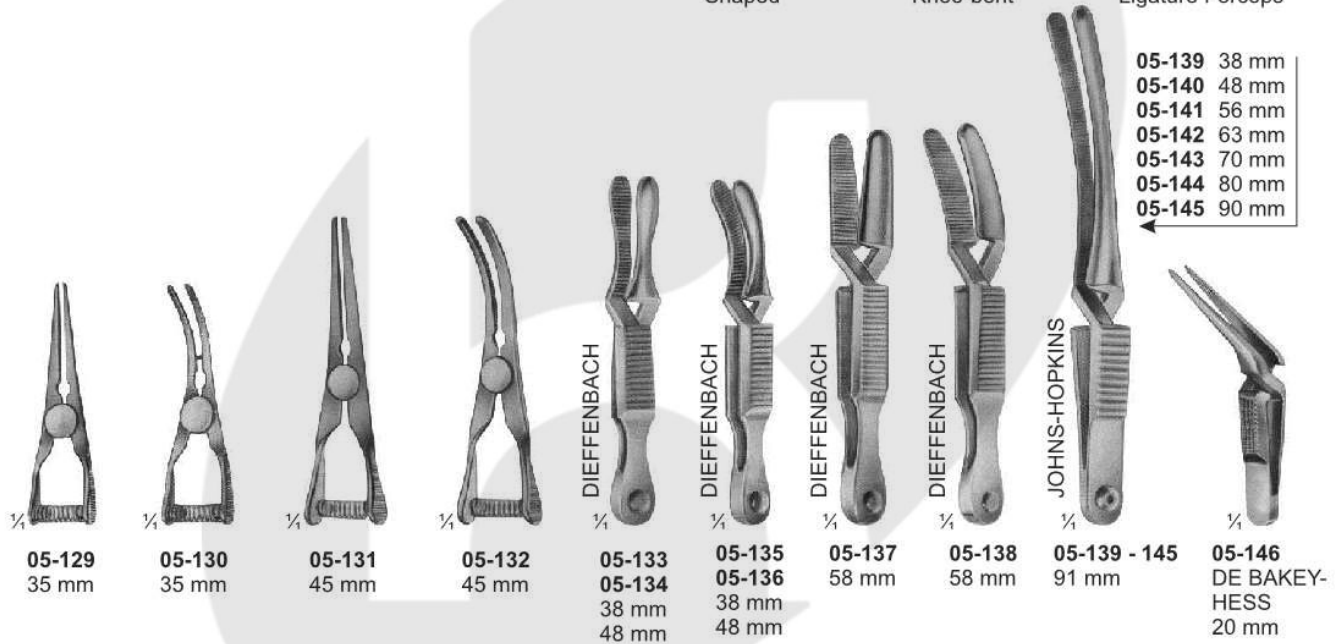
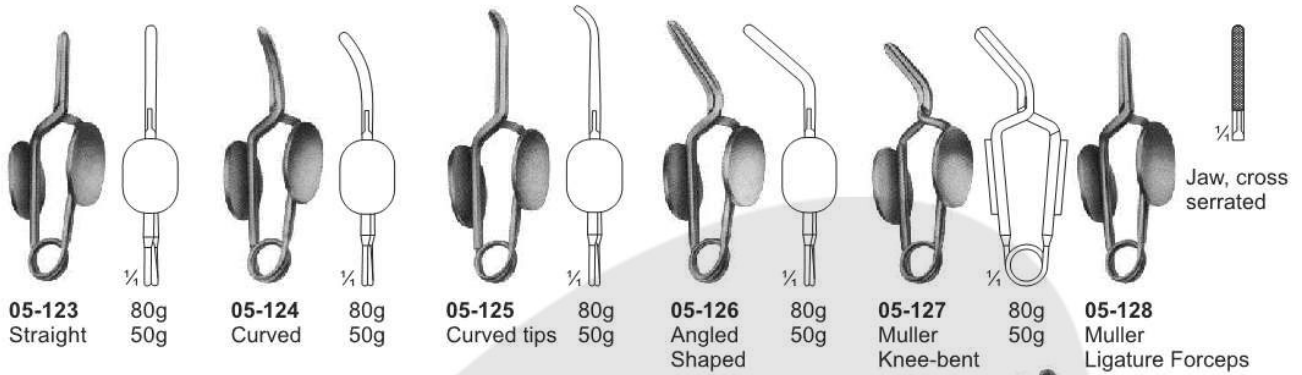

Delicate Haemostatic Forceps



Delicate Haemostatic Forceps

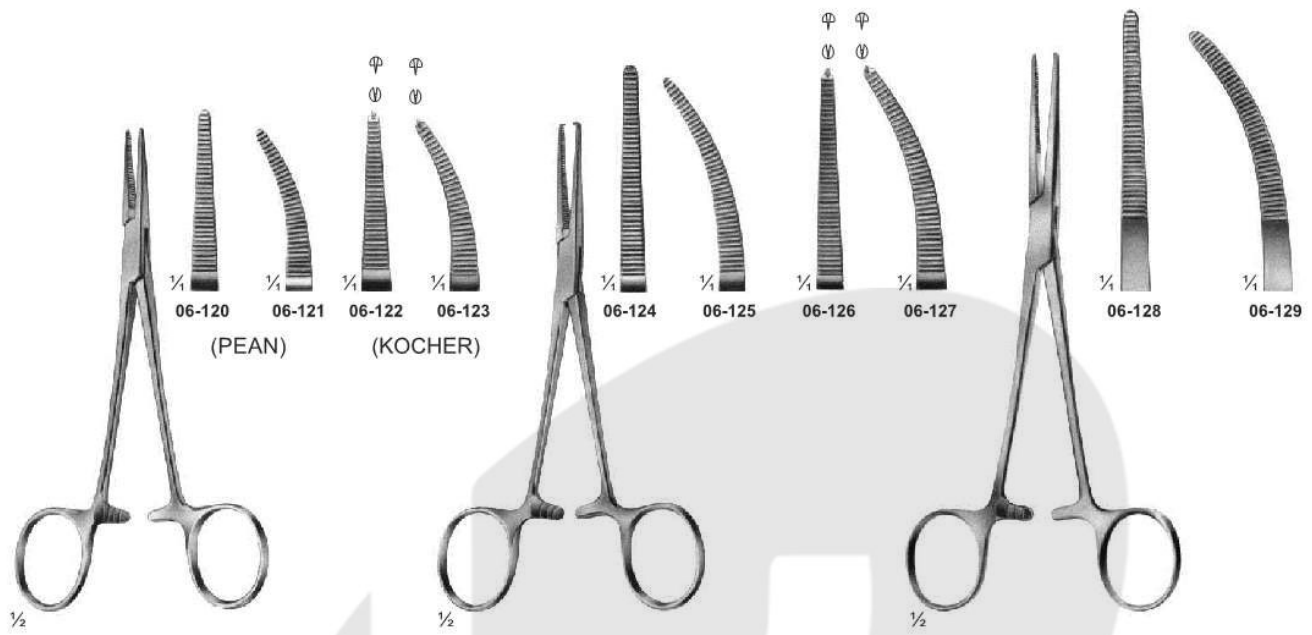

06-120 - 123
BABY-CRILE
140 mm

06-124 - 127
CRILE
140 mm

06-128 - 129
RANKIN
160 mm

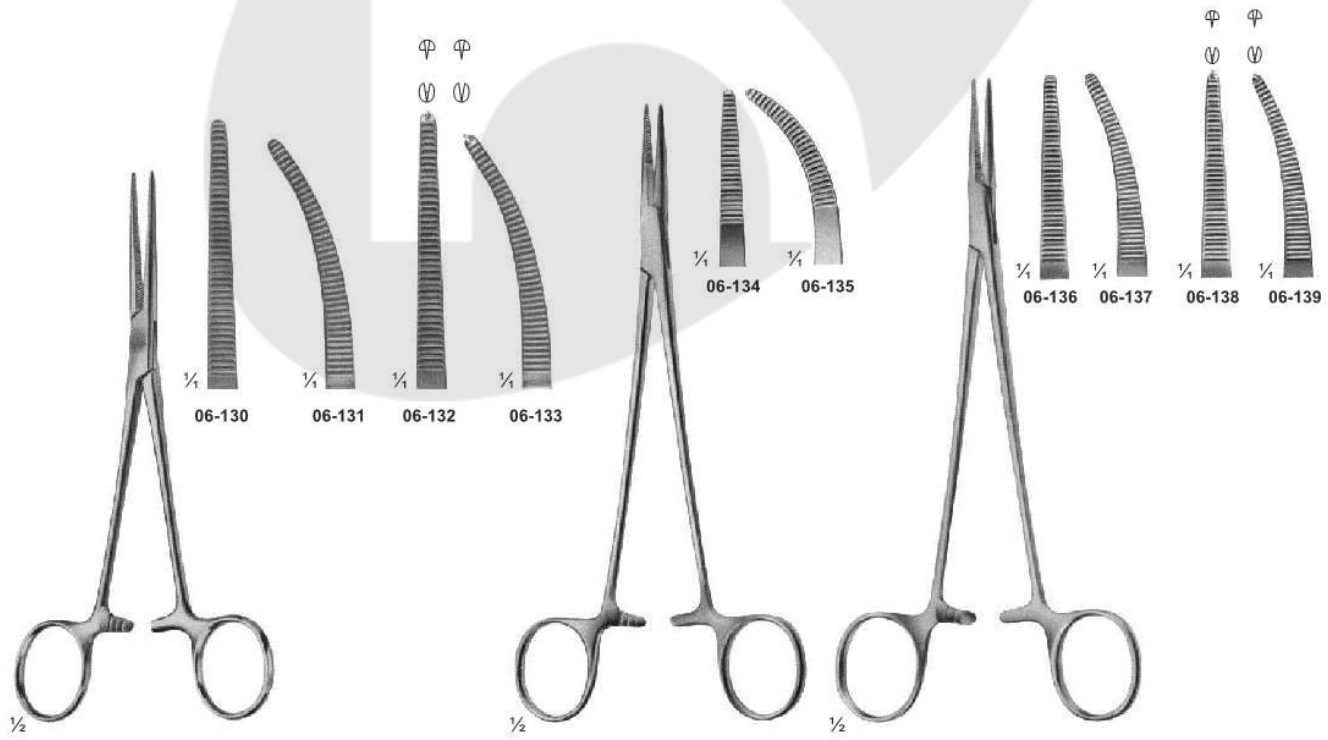

06-130 - 133
CRILE
160 mm

06-134 - 135
ADSON
185 mm

06-136 - 139
HALSTED
185 mm

Delicate Haemostatic Forceps

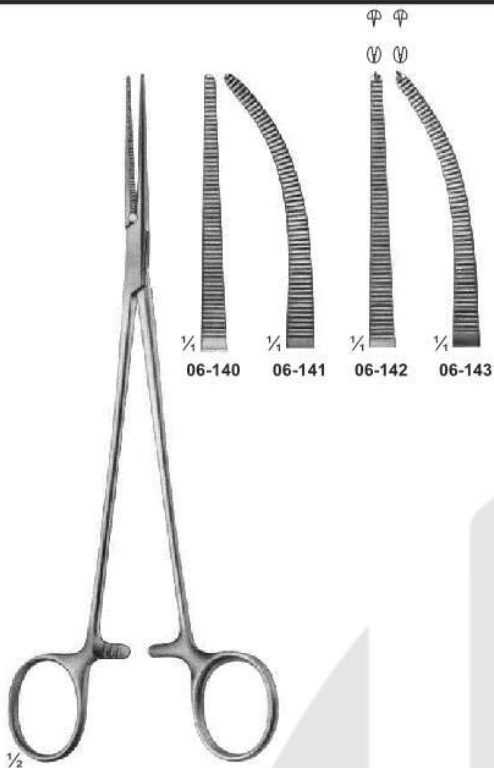

06-140 - 143
HALSTED-MOSQUITO
200 mm

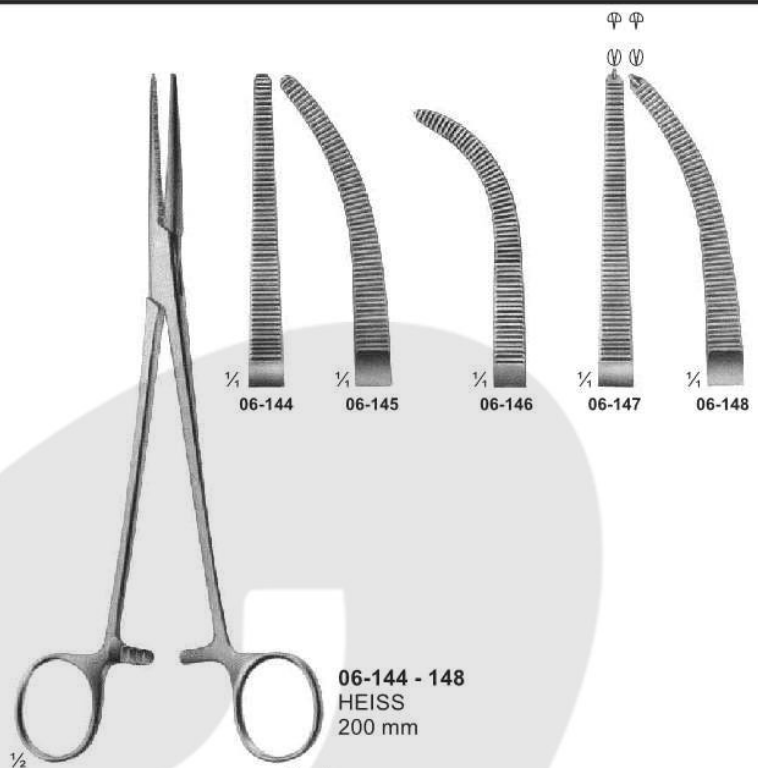

06-144 - 148
HEISS
200 mm

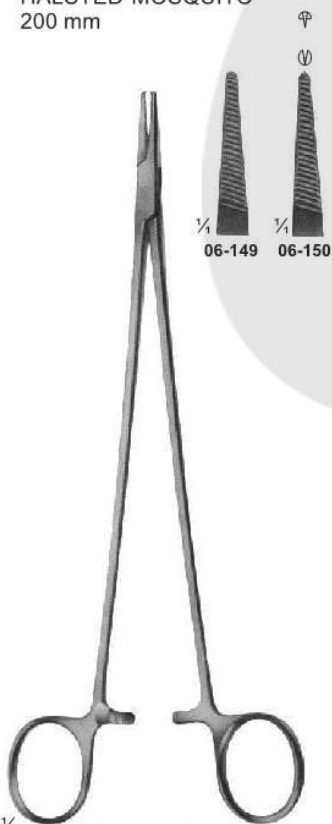

06-149 - 150
HALSTED
215 mm

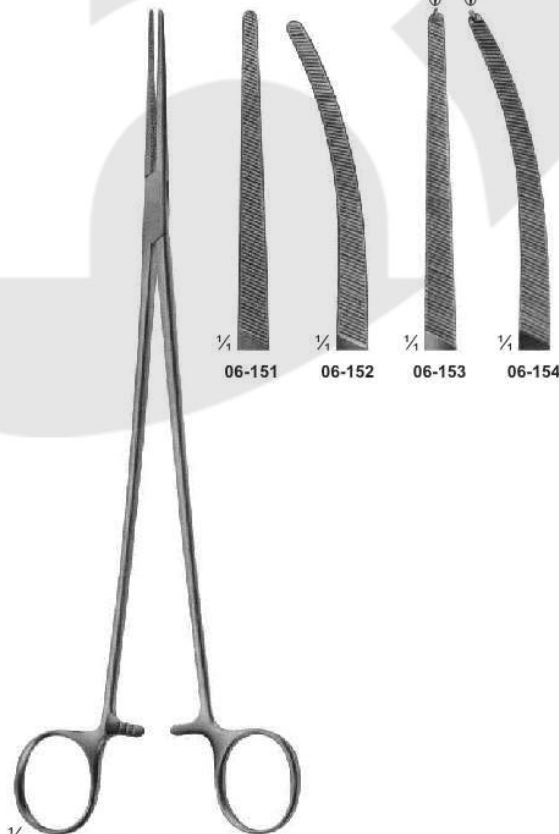

06-151 - 154
BENGOLEA
245 mm

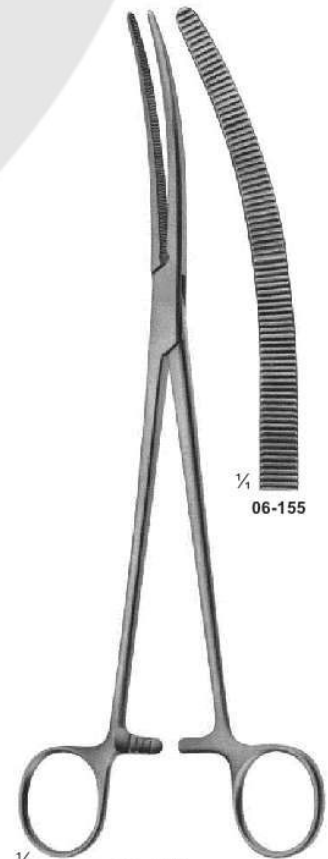

06-155
CRAFOORD
245 mm

Haemostatic Forceps

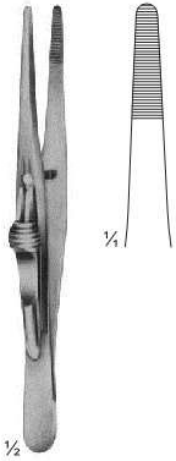

06-156
FRICKE
Artery forceps
130 mm

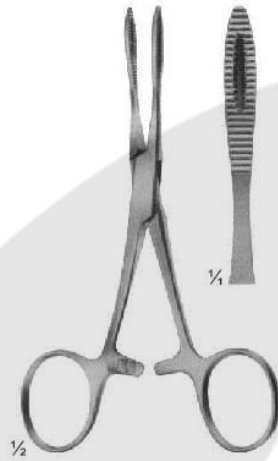

06-157
KRONLEIN
130 mm

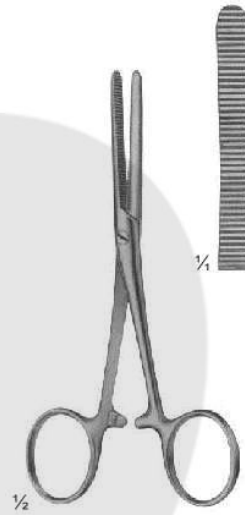

06-158
PEAN
125 mm

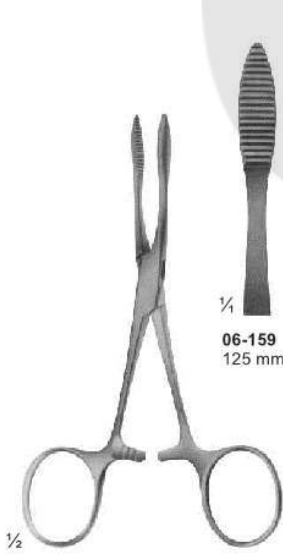

06-159 - 160
PEAN



06-159
125 mm



06-160
140 mm

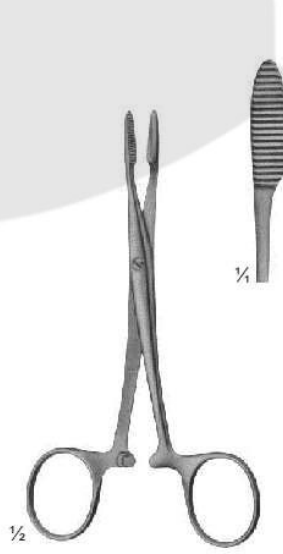

06-161
PEAN

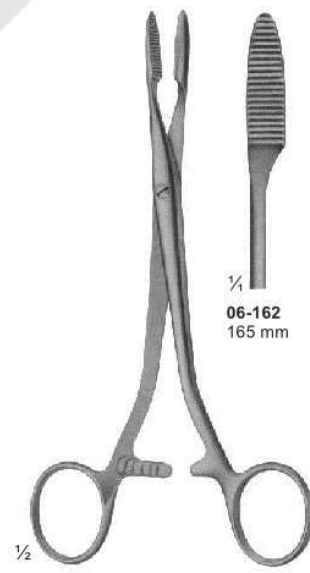

06-162 - 163
PEAN



06-162
165 mm



06-163
185 mm

Haemostatic Forceps

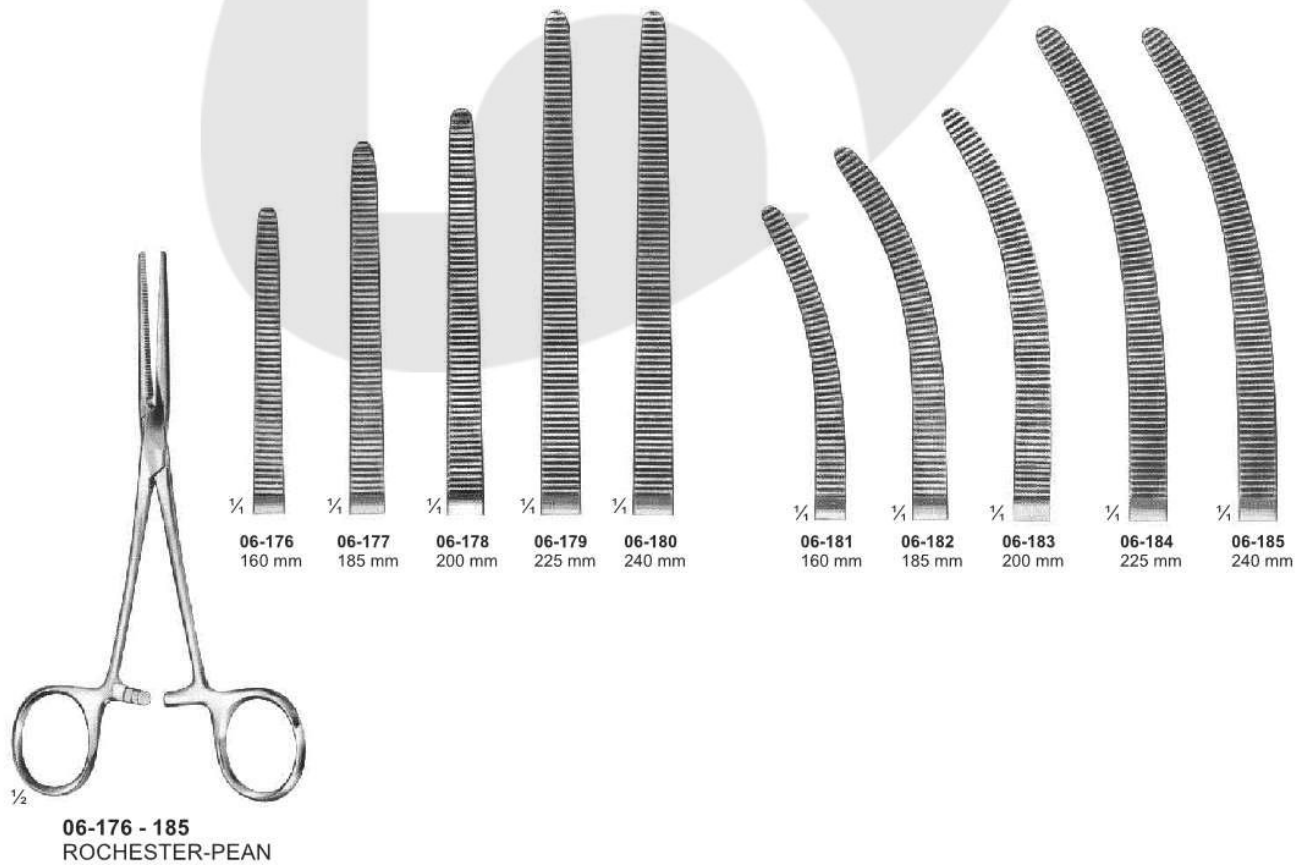
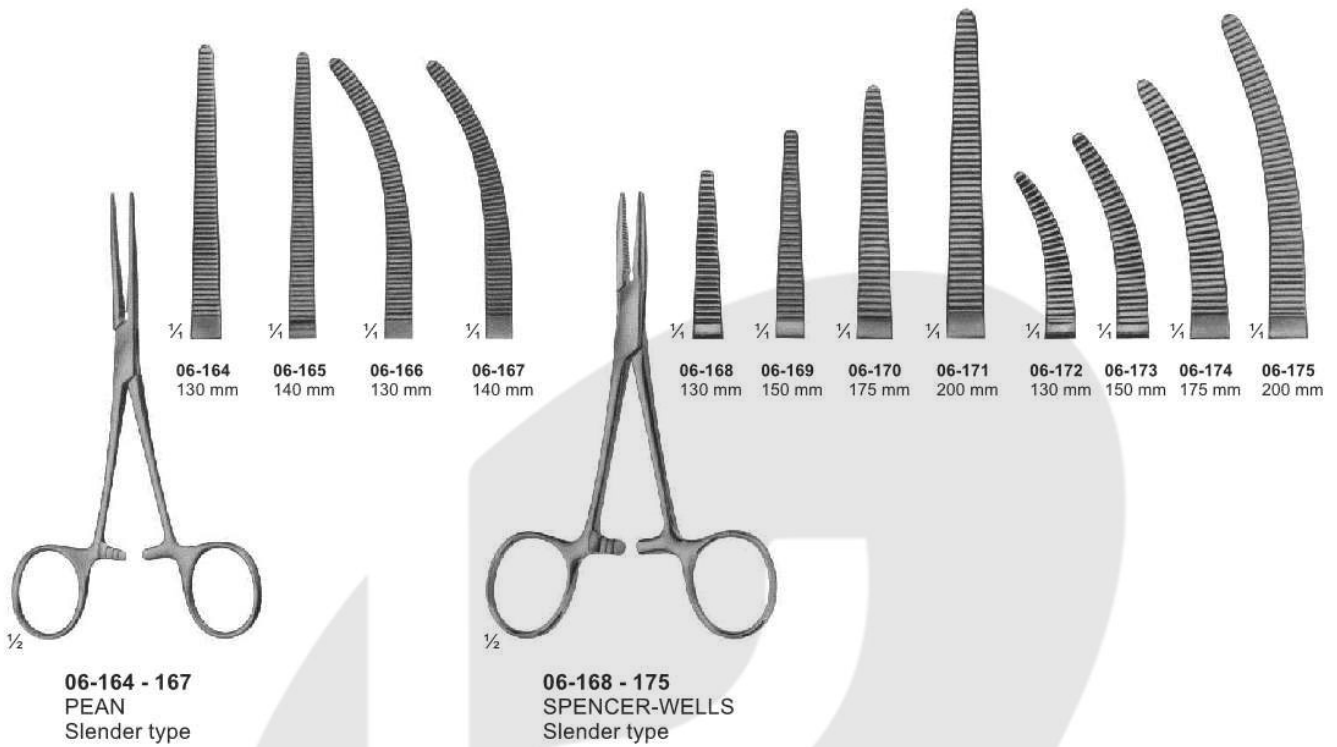

Haemostatic Forceps

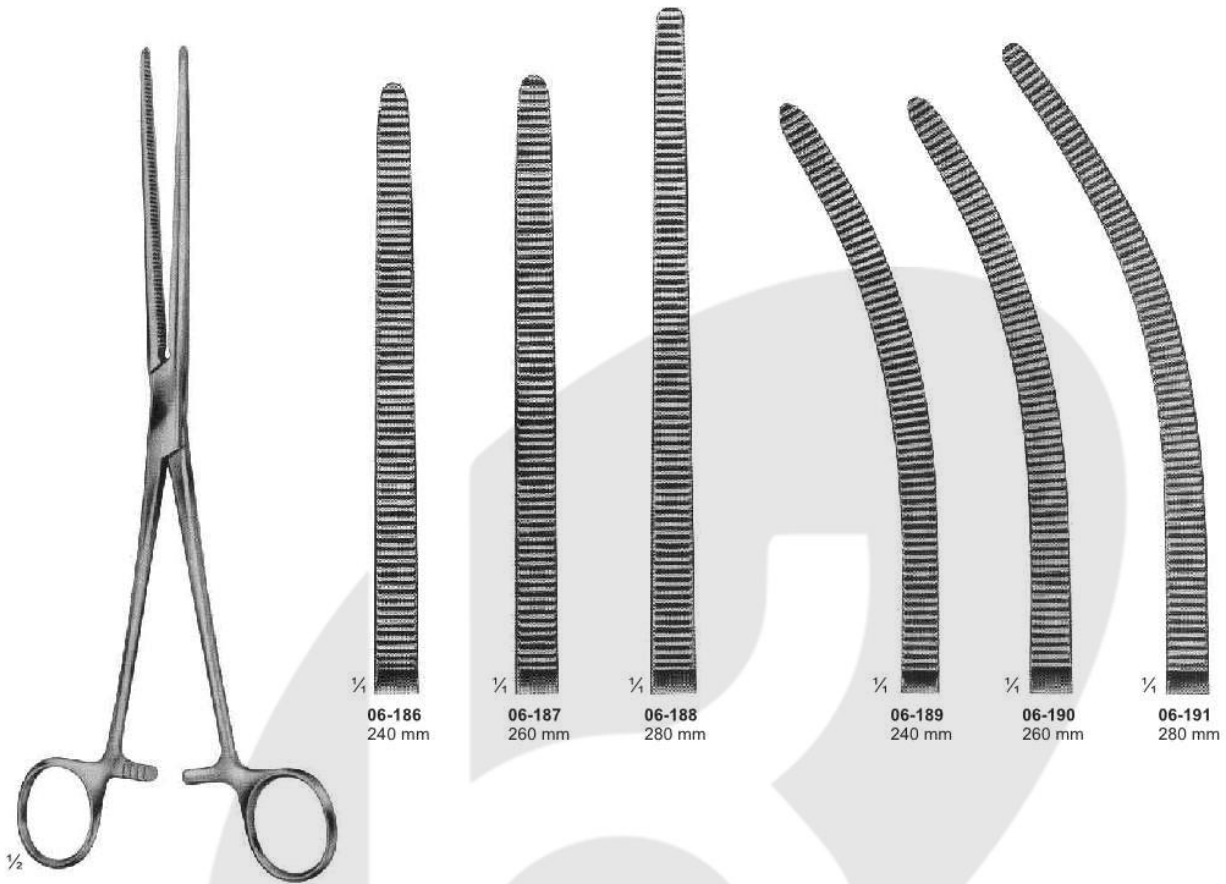

06-186 - 191
PEAN

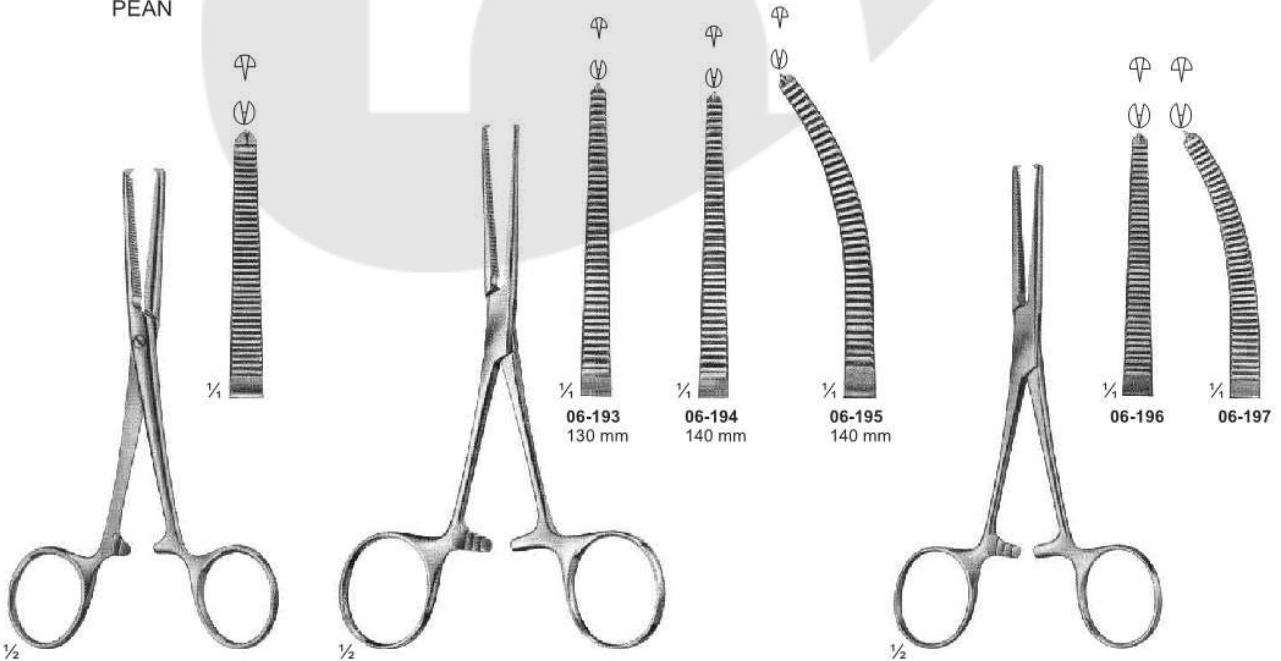

06-192
KOCHER
Strong Pattern
145 mm

06-193 - 195
KOCHER

06-196 - 197
ROCHESTER-OCHSNER
140 mm

Haemostatic Forceps

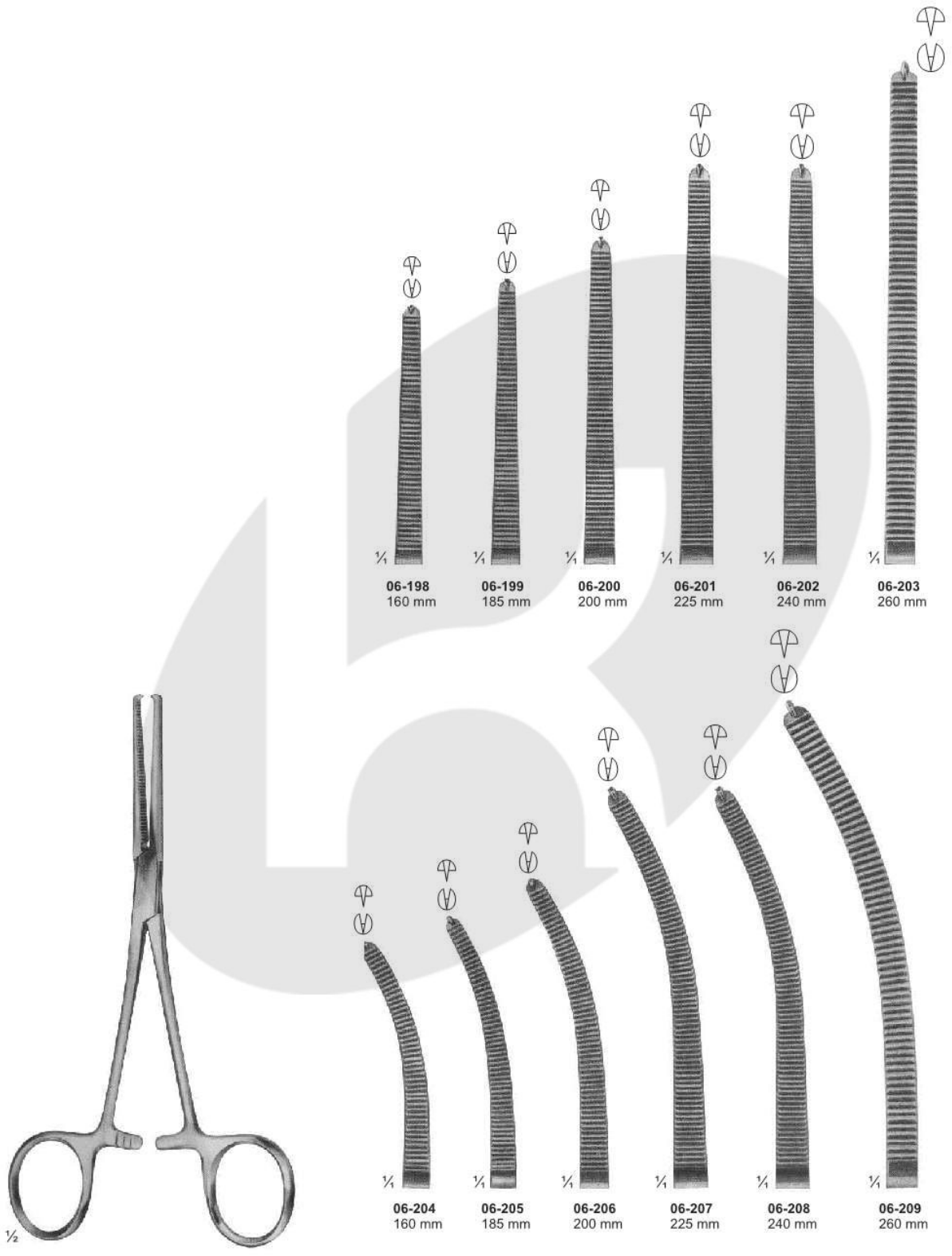

06-198 - 209
KOCHER-OCHSNER

Haemostatic Forceps, Special Pattern, Tonsil Forceps

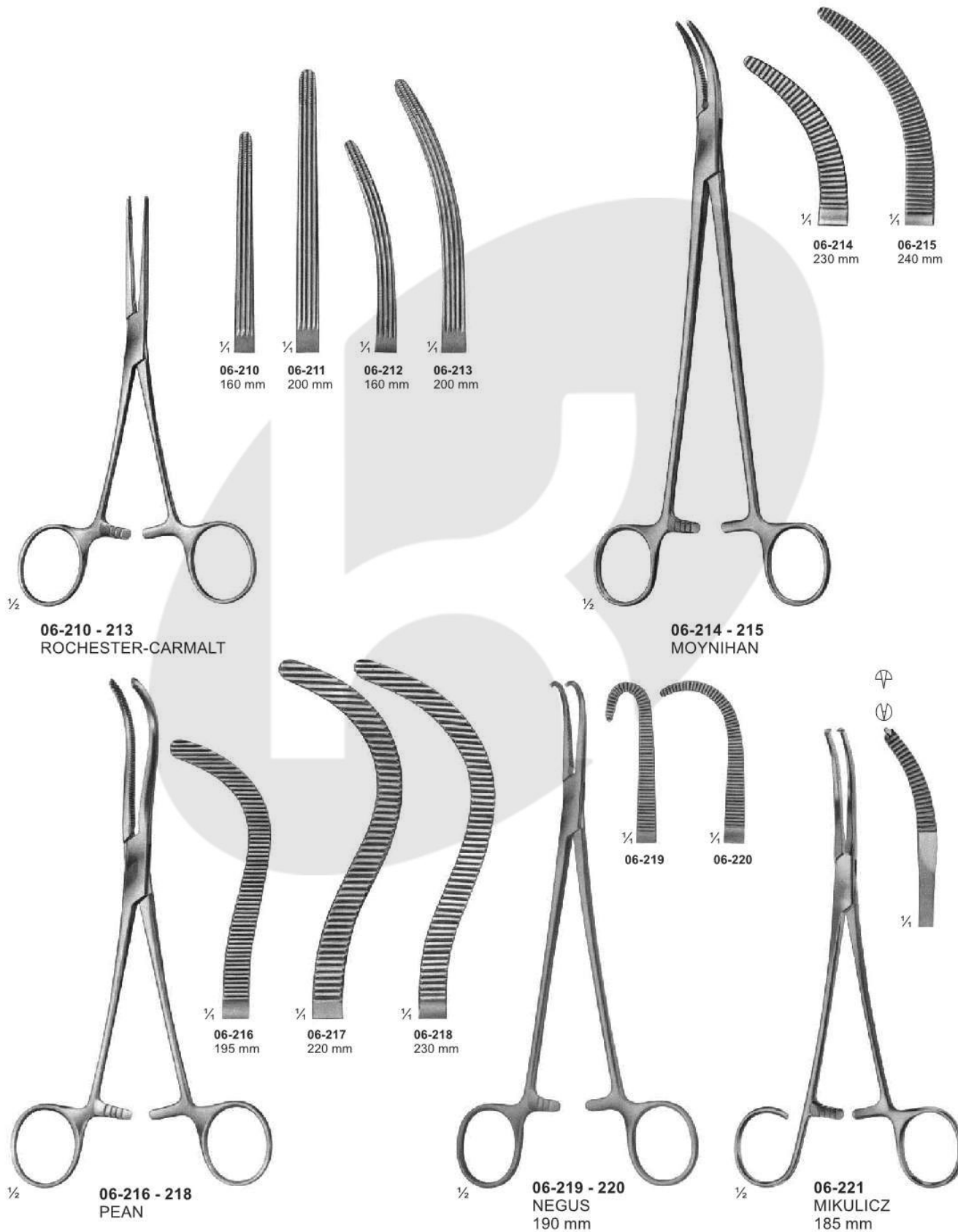

Dissecting- and Ligature Forceps

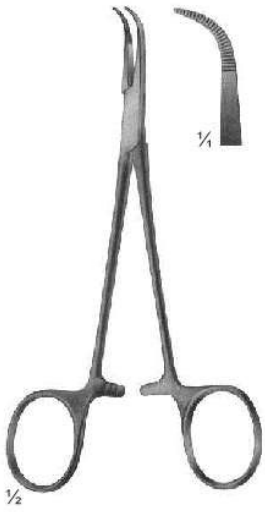

06-222
MICRO-ADSON
140 mm

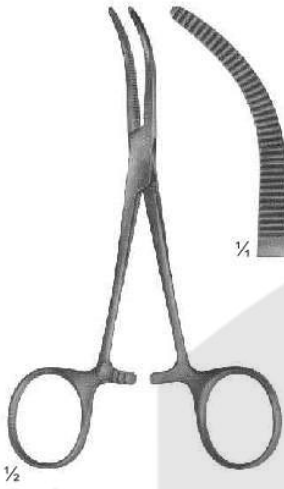

06-223
BABY-OVERHOLT
135 mm

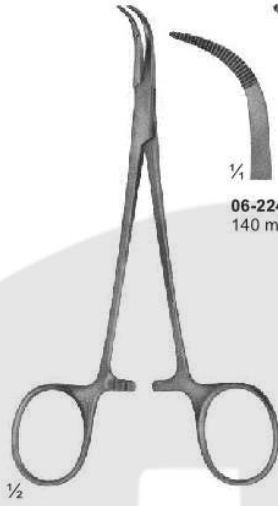

06-224 - 225
BABY-MIXTER

06-224
140 mm

06-225
180 mm

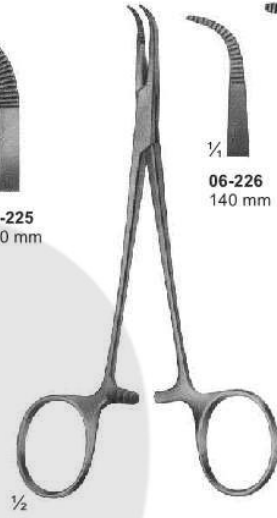

06-226 - 227
BABY-ADSON

06-226
140 mm

06-227
180 mm



06-228
NISSEN



06-229 - 230
YASARGIL
195 mm



06-231
OVERHOLT-MIXTER



Dissecting- and Ligature Forceps

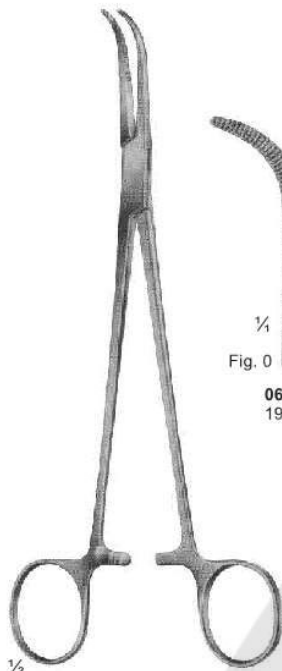

1/2

06-232 - 243
OVERHOLT-GEISSENDOERFER

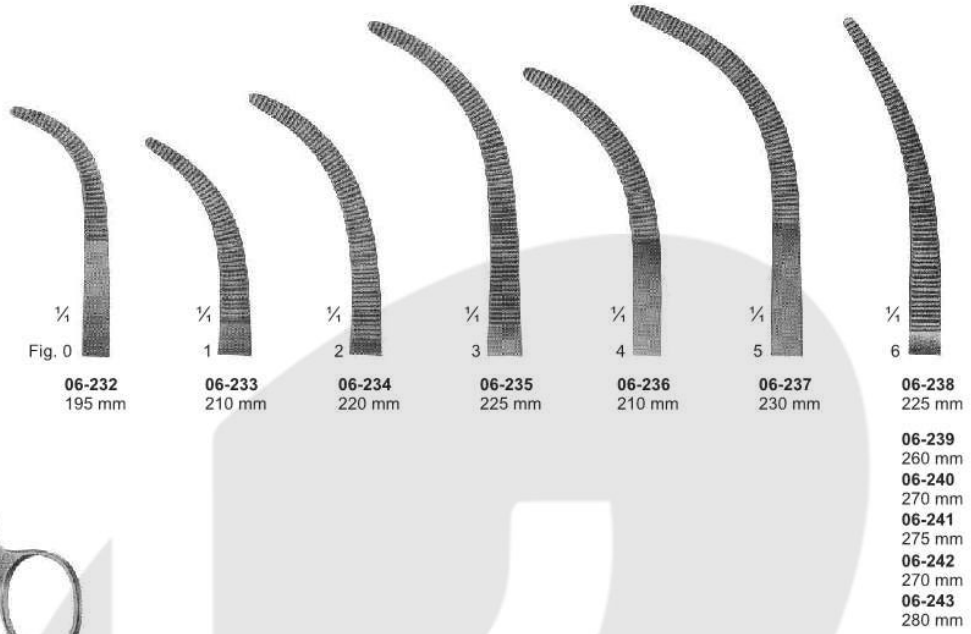

Fig. 0	1	2	3	4	5	6
06-232 195 mm	06-233 210 mm	06-234 220 mm	06-235 225 mm	06-236 210 mm	06-237 230 mm	06-238 225 mm

06-239
260 mm
06-240
270 mm
06-241
275 mm
06-242
270 mm
06-243
280 mm



1/2

06-244 - 251
OVERHOLT
fine pattern

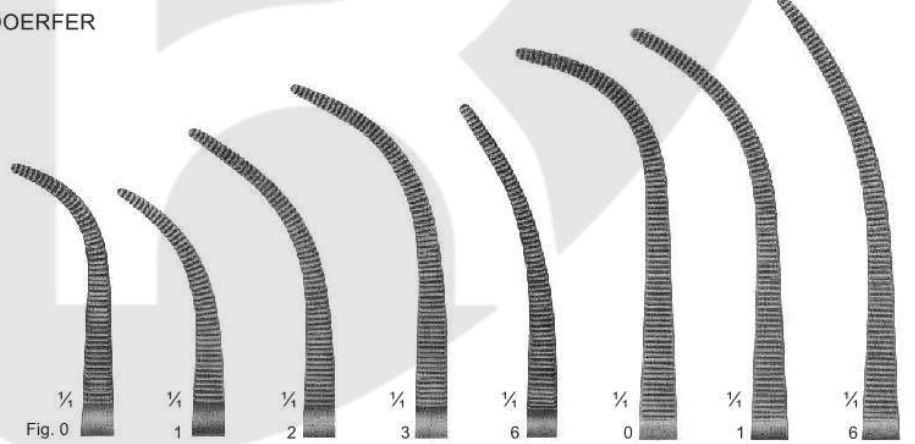
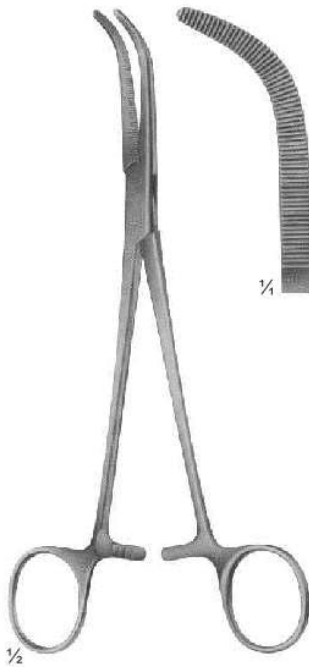
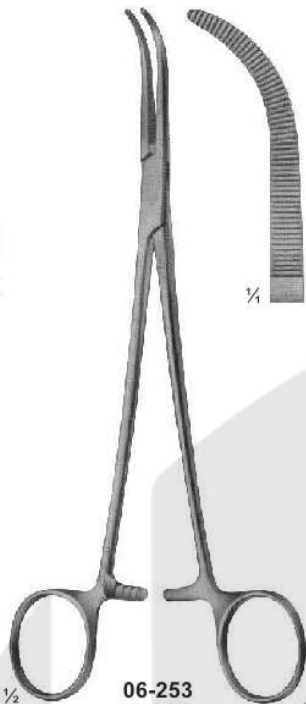

Fig. 0	1	2	3	6	0	1	6
06-244 215 mm	06-245 210 mm	06-246 220 mm	06-247 225 mm	06-248 225 mm	06-249 295 mm	06-250 295 mm	06-251 300 mm

Dissecting- and Ligature Forceps



06-252
MIXTER-O'SHAUGNESSY
190 mm



06-253
HEISS
195 mm

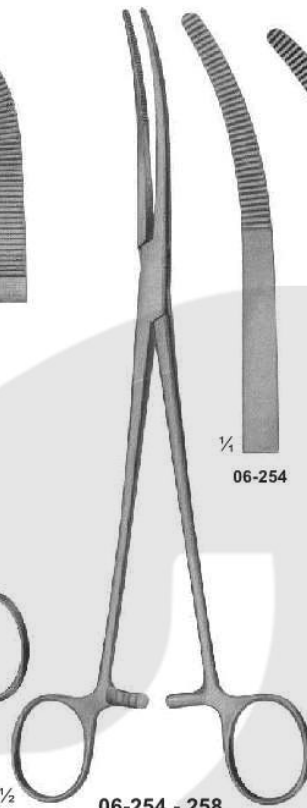

06-254 - 258
RUMEL
240 mm

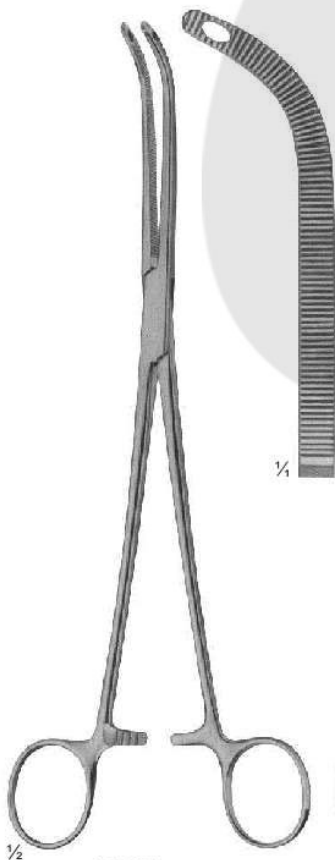
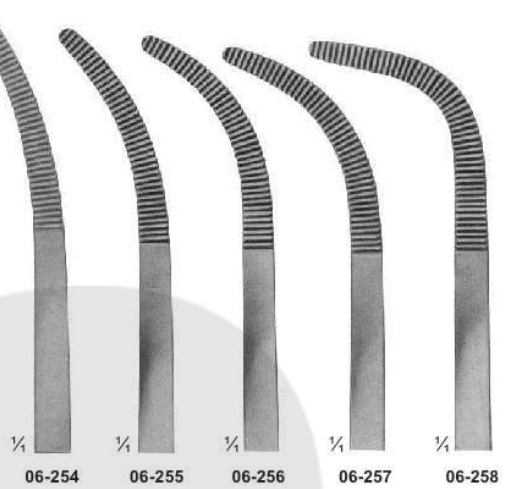

06-259
FINOCHIETTO
245 mm

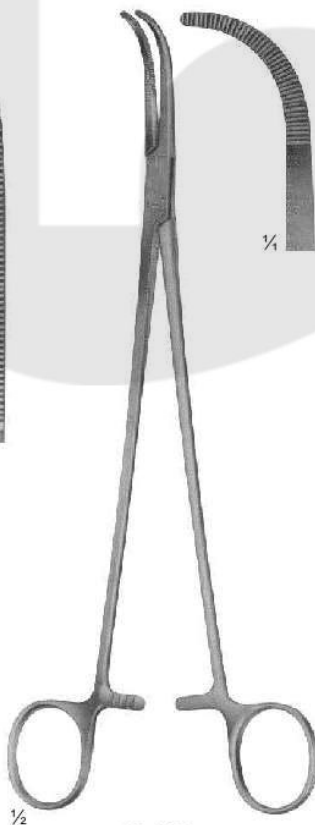

06-260
MIXTER
230 mm

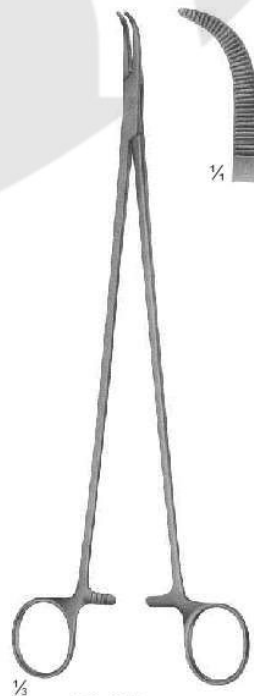

06-261
LAWRENCE
270 mm

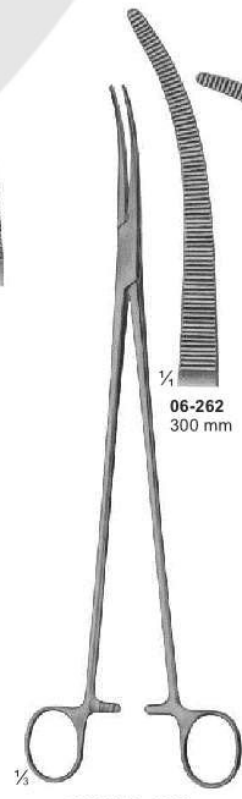

06-262 - 263
ZENKER



06-263
290 mm

Dissecting- and Ligature Forceps

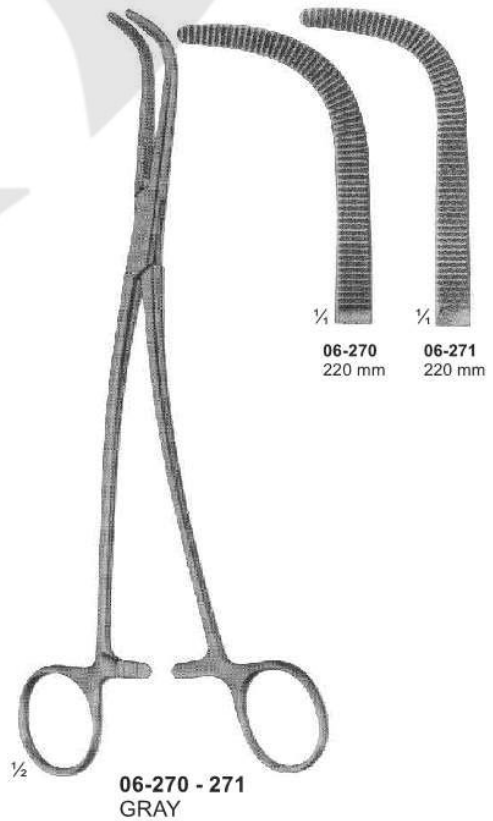
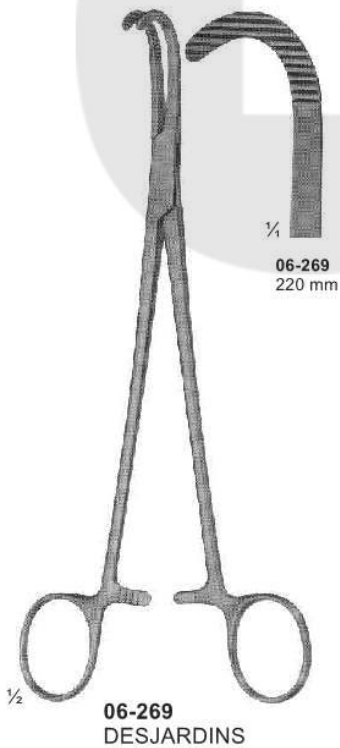
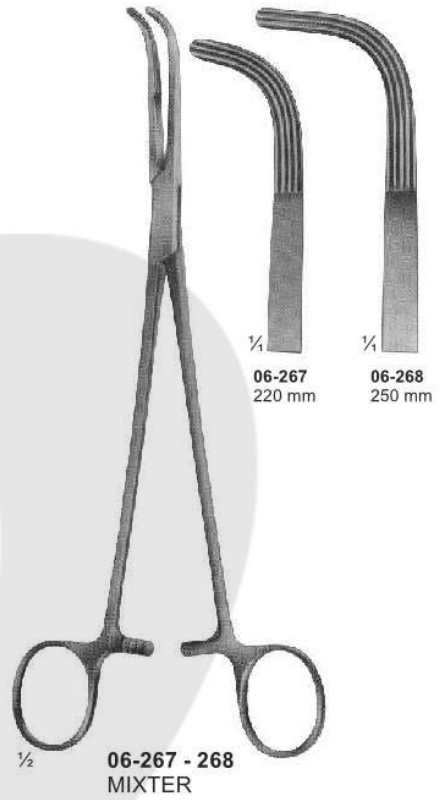
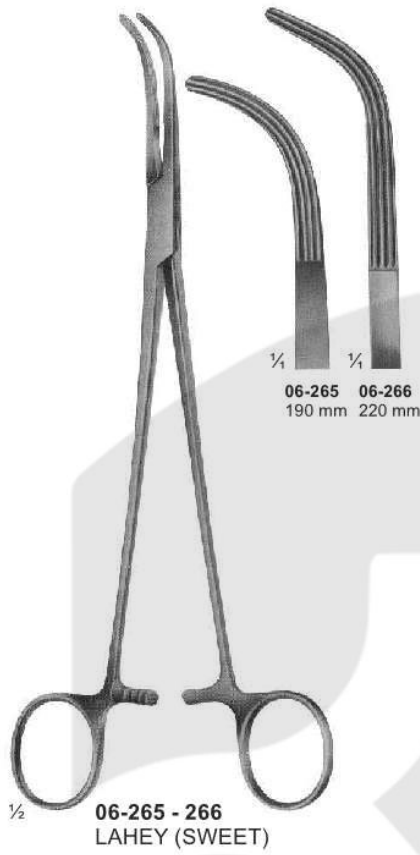
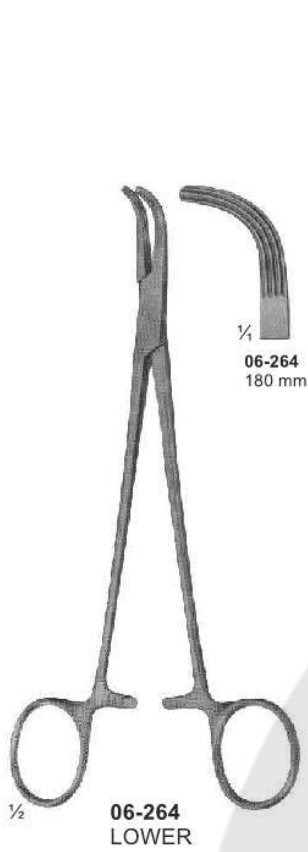

Peritoneum Forceps

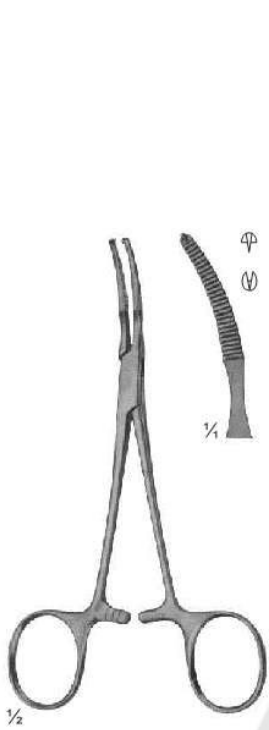

06-272
BABY-MIKULICZ
140 mm

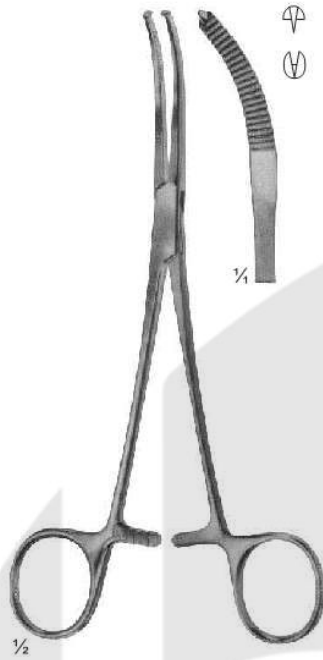

06-273
MIKULICZ
185 mm

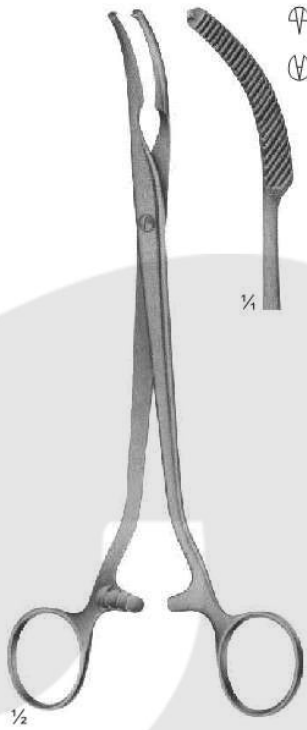

06-274
MIKULICZ
205 mm

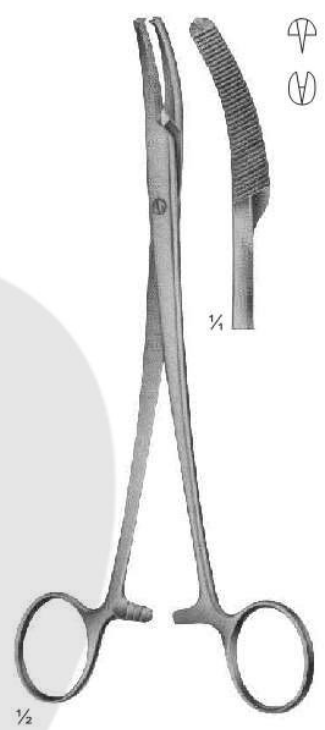

06-275
MIKULICZ
200 mm

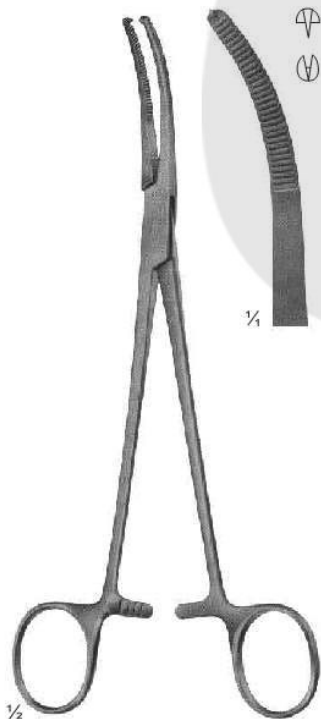

06-276
MIKULICZ
205 mm

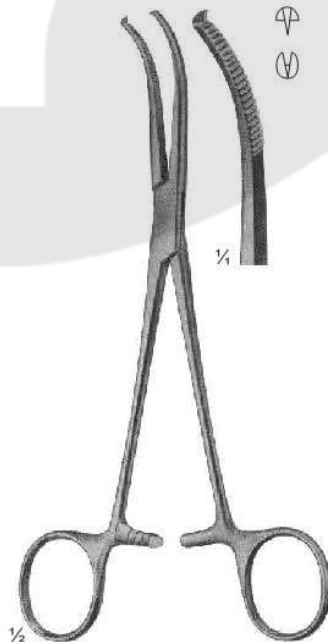

06-277
MIKULICZ
185 mm

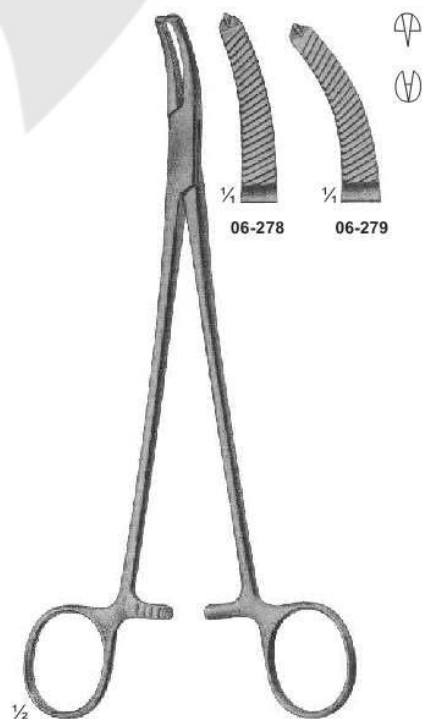

06-278 - 279
FAURE
205 mm

Hysterectomy Forceps

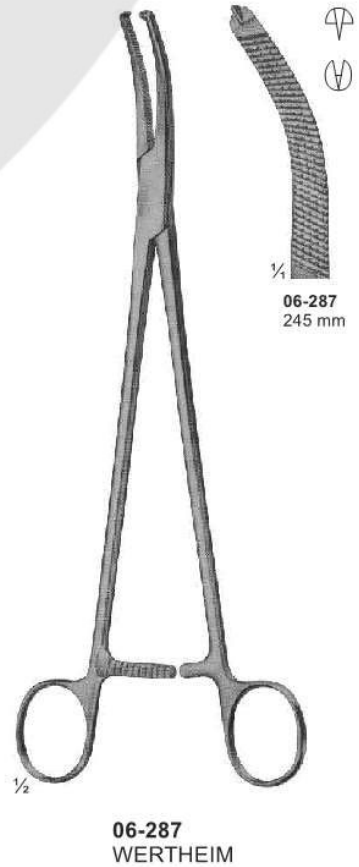
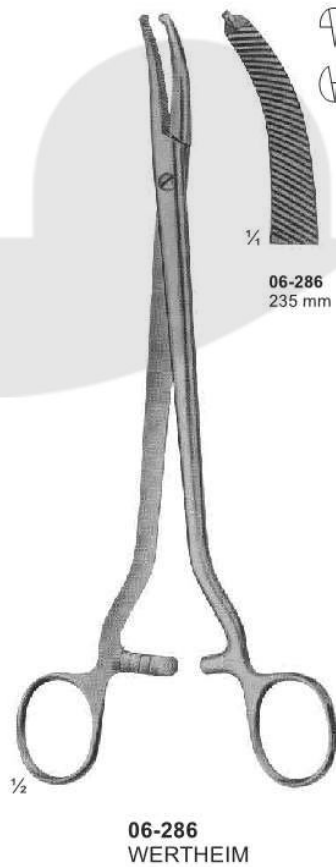
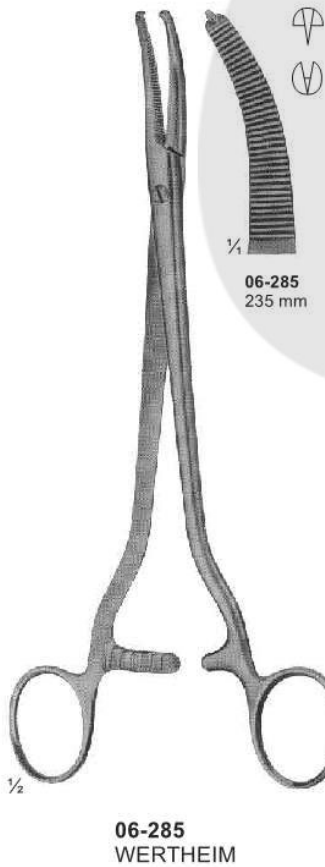
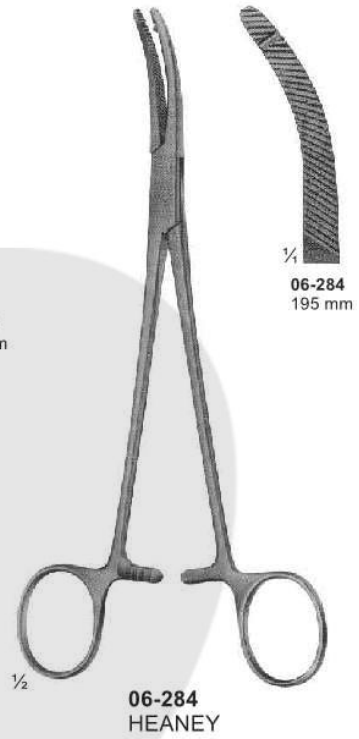
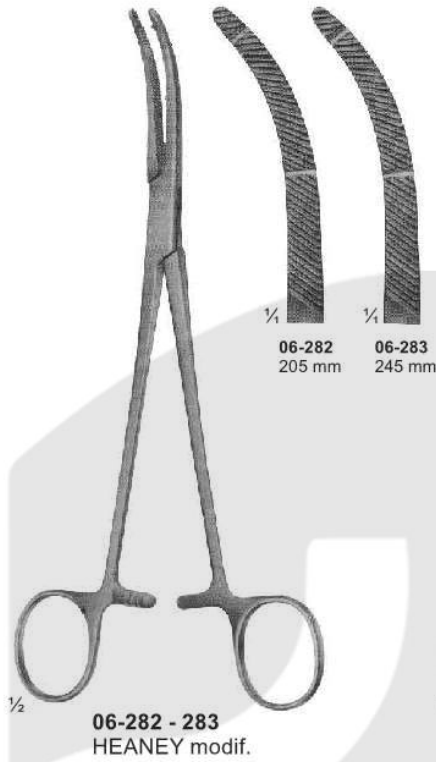
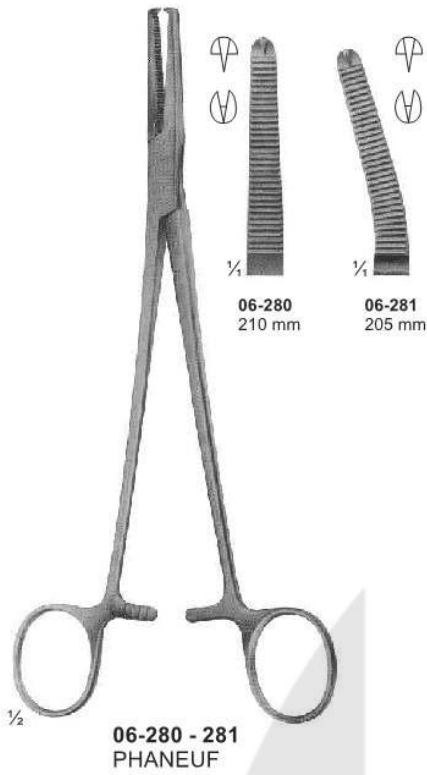

Hysterectomy Forceps and Vaginal Clamps

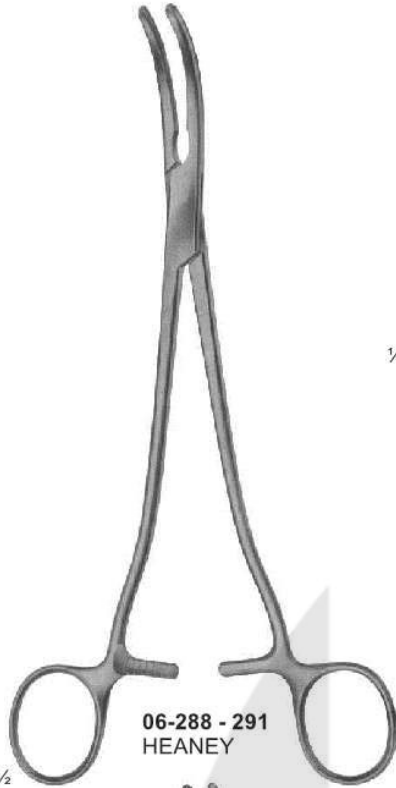

06-288 - 291
HEANEY

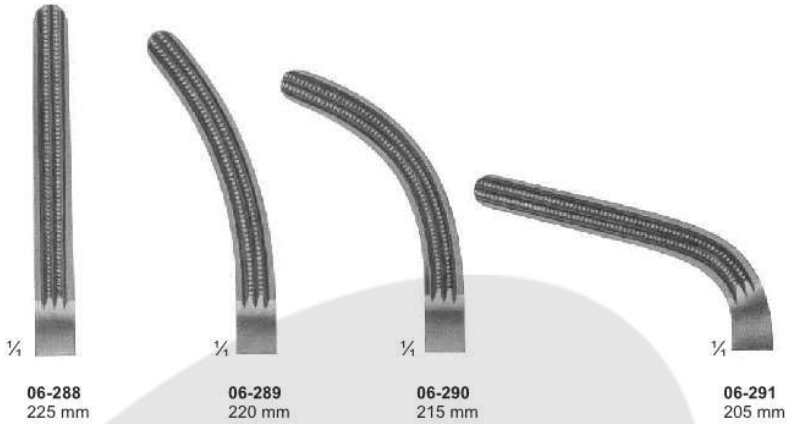

06-288
225 mm

06-289
220 mm

06-290
215 mm

06-291
205 mm

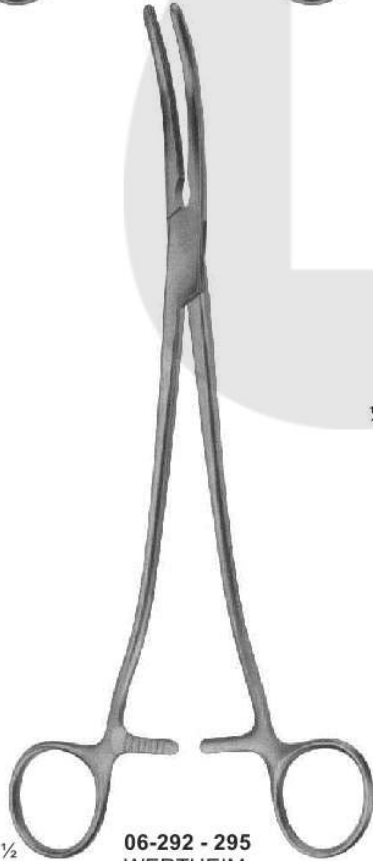

06-292 - 295
WERTHEIM
Parametrium clamps

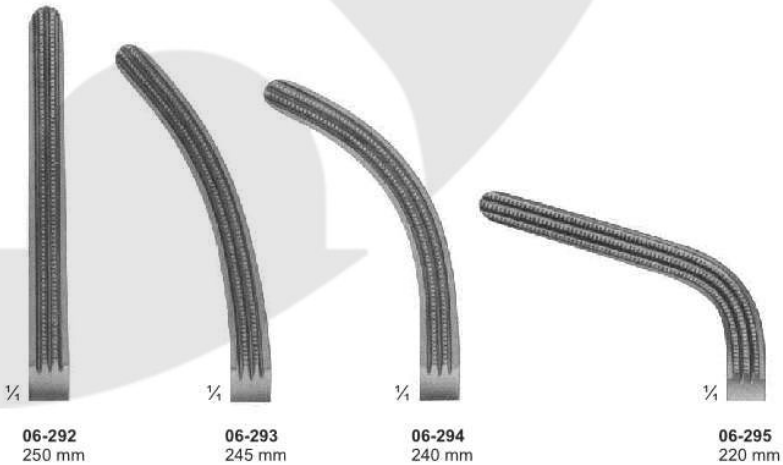

06-292
250 mm

06-293
245 mm

06-294
240 mm

06-295
220 mm

Hysterectomy Forceps and Vaginal Clamps and Compression Forceps



1/2
06-296
 WERTHEIM
 Hysterectomy Forceps
 255 mm

1/2
06-297
 WERTHEIM
 Parametrium Clamp
 260 mm

1/4
06-298 **06-299** **06-300**
 255 mm 265 mm 275 mm

1/2
06-298 - 300
 DICK

Hysterectomy Forceps and Vaginal Clamps and Compression Forceps

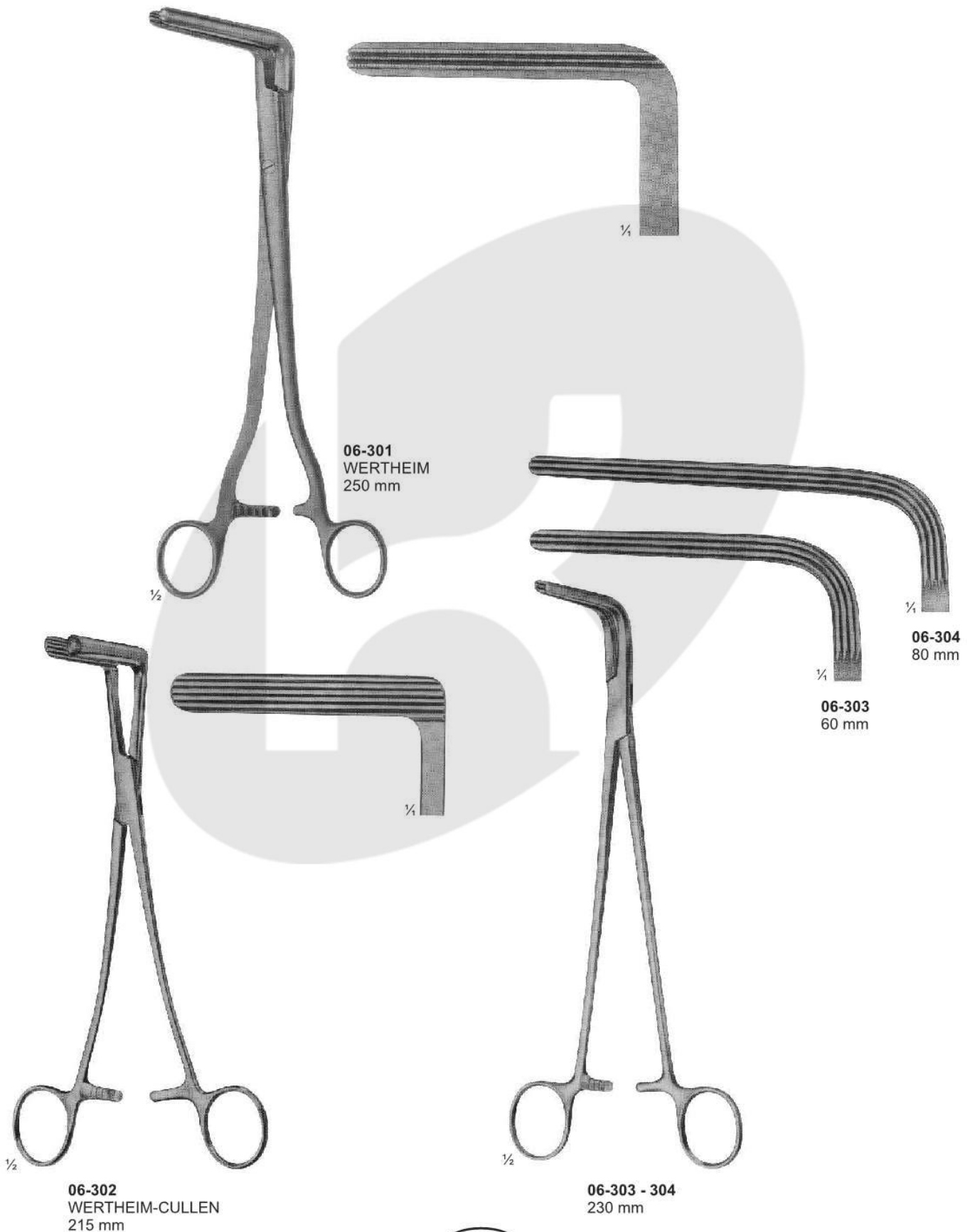

Needle Holders For Micro Surgery



07-101
ROHRSCHEIDER
With copper inserts
100 mm



07-102
KALT
With catch
135 mm



07-103
ARRUGA
With catch
135 mm



07-104 - 105
CASTROVIEJO
With catch
145 mm



07-106 - 107
CASTROVIEJO
With Catch
160 mm

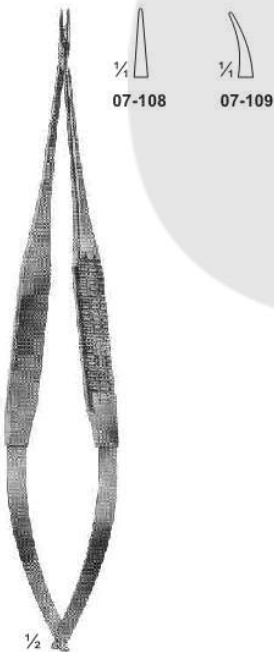

07-108 - 109
Without catch
185 mm



07-110 - 111
JACOBSON
185 mm



07-112
Without catch
195 mm

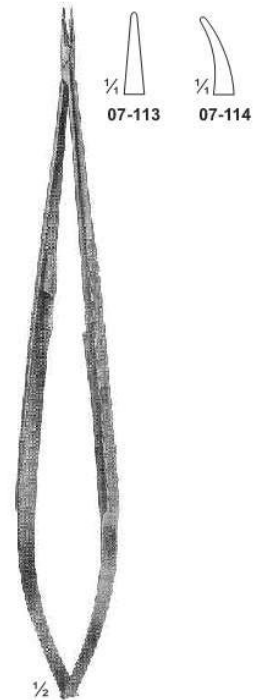

07-113 - 114
YASARGIL
With catch
200 mm

Micro Needle Holders With Round Handles

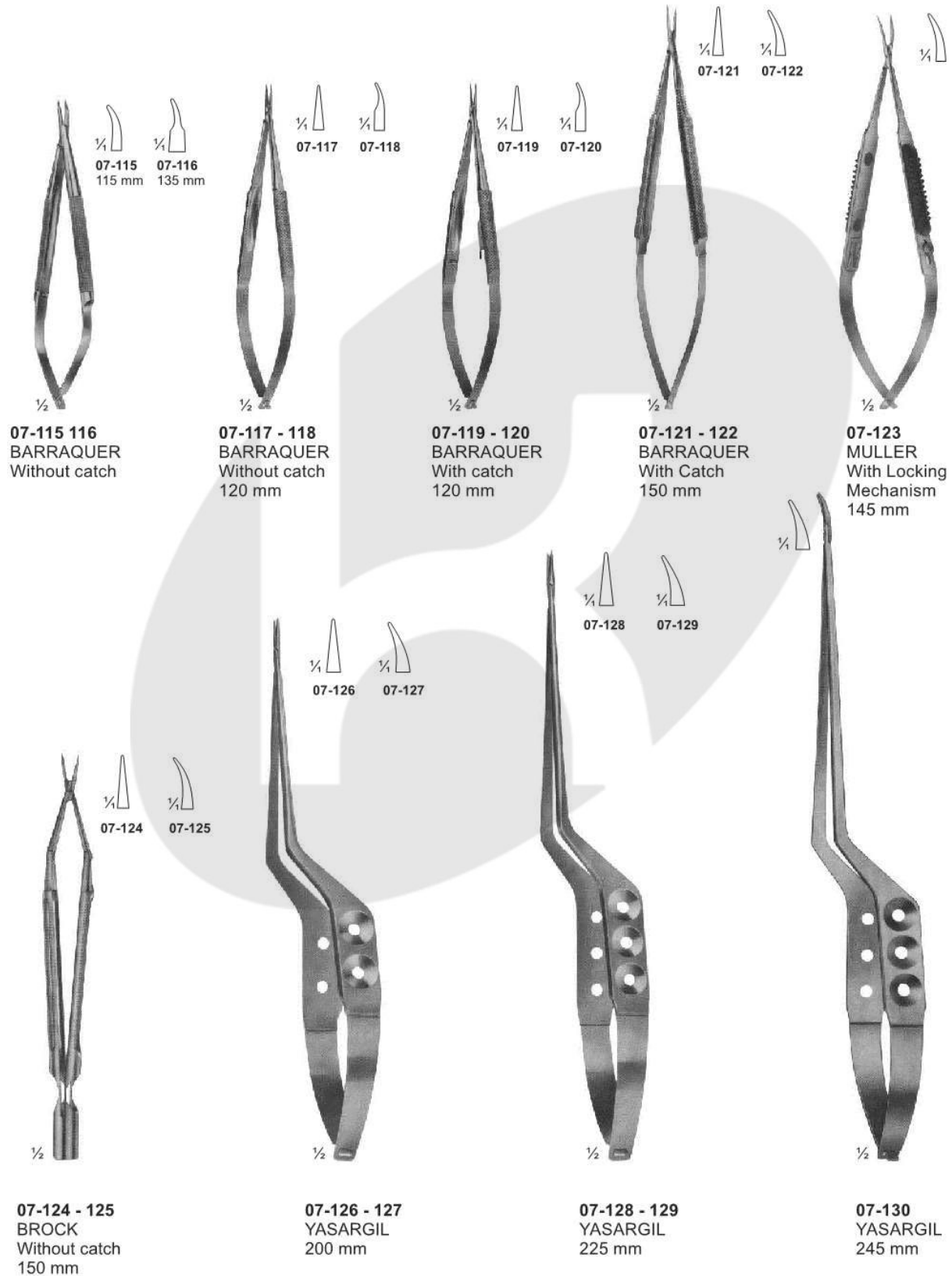

Needle Holders

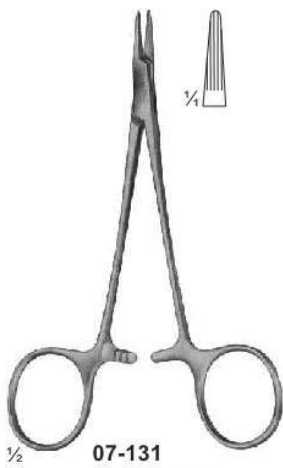

1/2 **07-131**
CONVERSE
125 mm



1/2 **07-132**
WEBSTER
125 mm

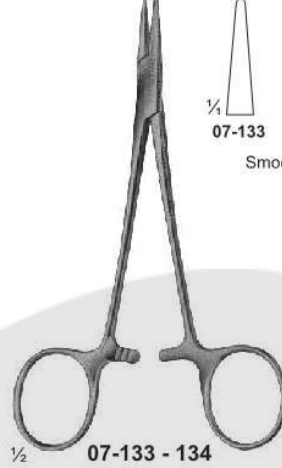

1/2 **07-133 - 134**
HALSEY
130 mm

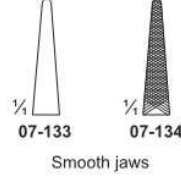

Smooth jaws

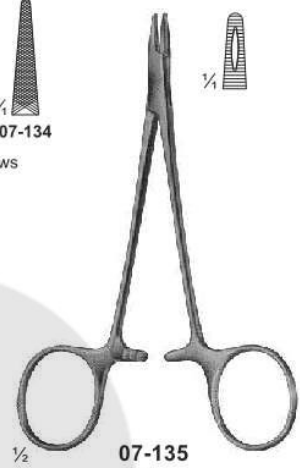

1/2 **07-135**
DERF
130 mm



1/2 **07-136**
DOYEN
125 mm



1/2 **07-137**
BAUMGARTNER
145 mm

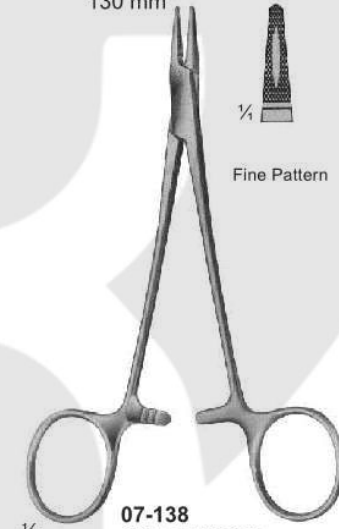

1/2 **07-138**
CRILE-WOOD
150 mm



Fine Pattern



1/2 **07-139**
CRILE-WOOD
160 mm



1/2 **07-140**
CRILE-MURRAY
150 mm

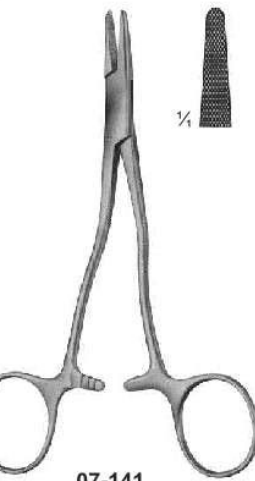

1/2 **07-141**
KILNER
135 mm



1/2 **07-142**
ADSON
175 mm

Needle Holders



Needle Holders

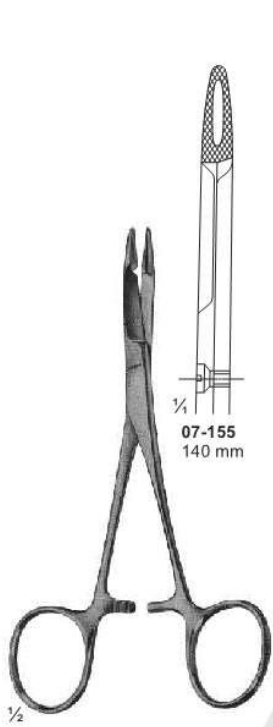

07-155 - 156
HEGAR-OLSEN
255 mm

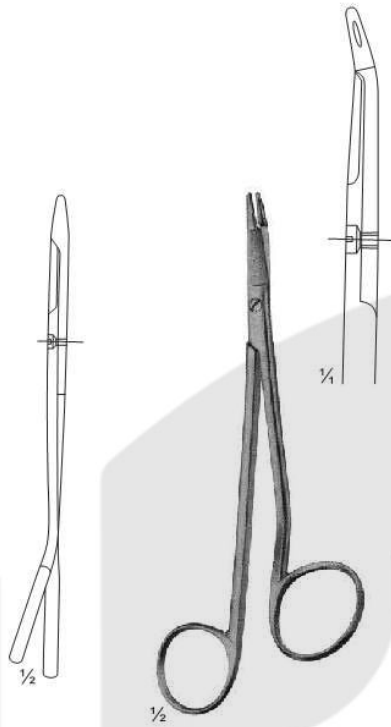

07-157
GILLIES
150 mm

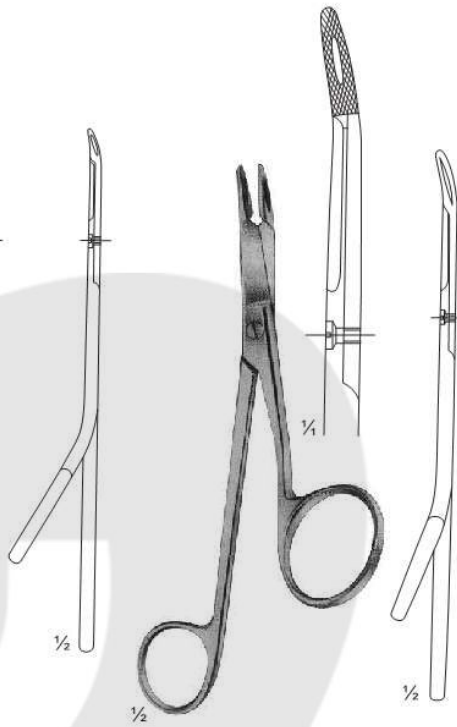

07-158
GILLIES
160 mm

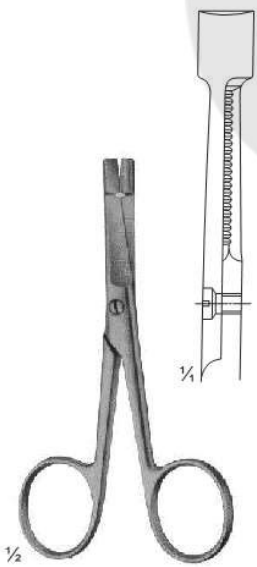

07-159
EISELSBERG
115 mm

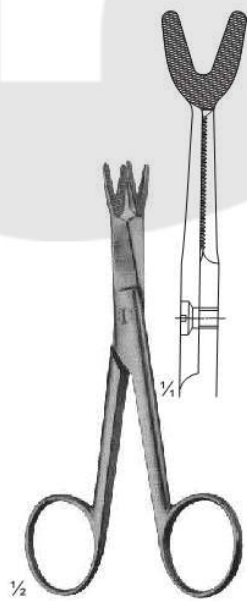

07-160
SCHOEMAKER-LOTH
125 mm



07-161
CRILE
150 mm



07-162
TONNIS
Elastic pattern for
dura- or intestinal suture
180 mm

Needle Holders

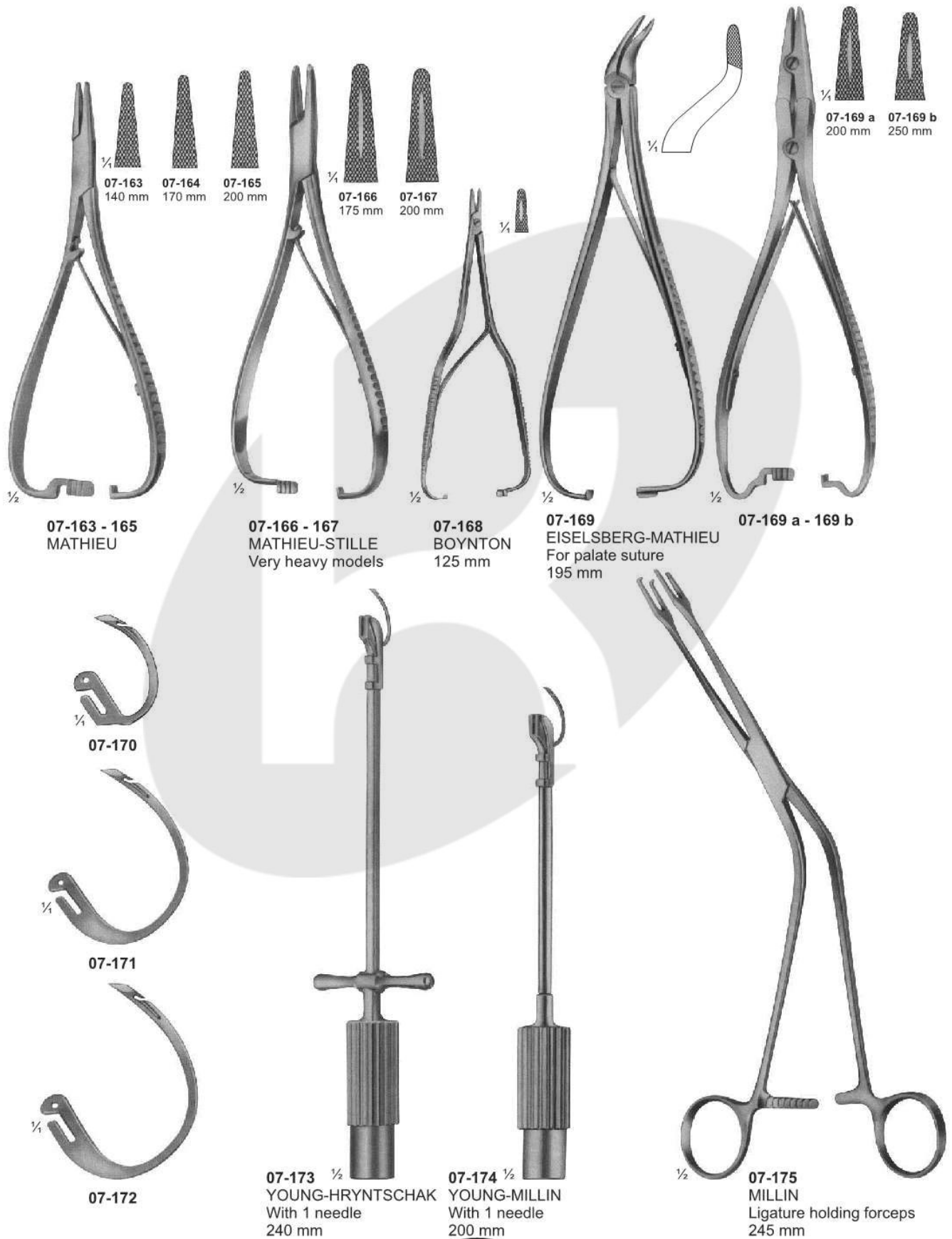

Suture Instruments - Reverdin Needles

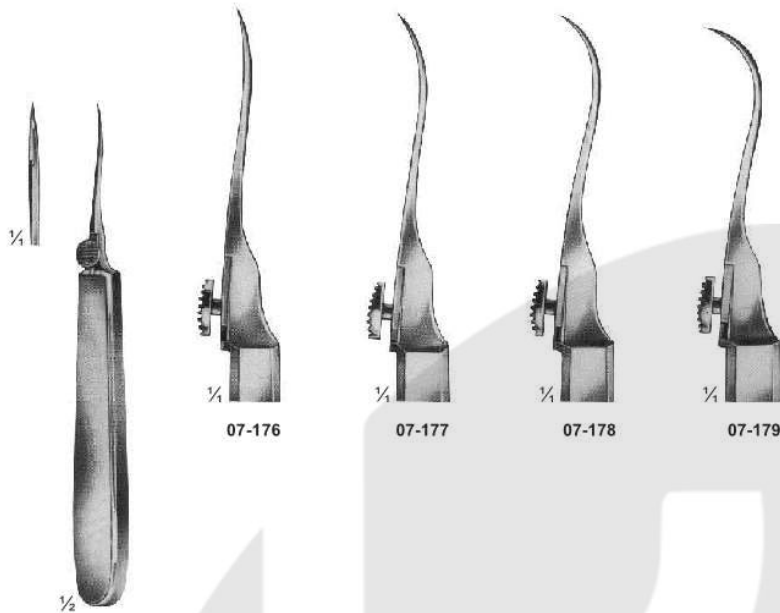

07-176 - 179
REVERDIN
140 mm



07-180 - 183
REVERDIN
195 mm

07-184 - 188
REVERDIN
220 mm

Suture Instruments - Ligature Needles

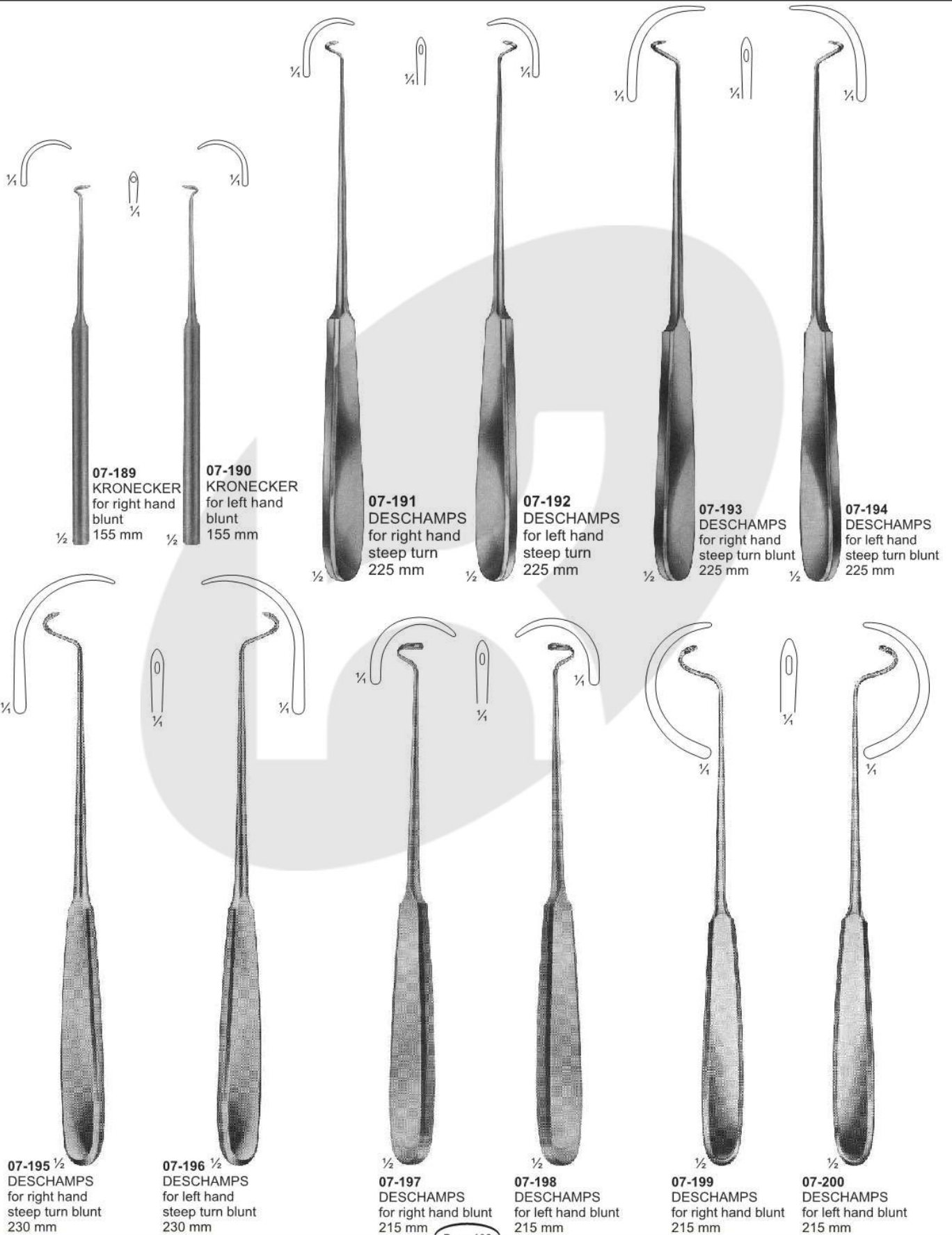

Suture Instruments - Ligature Needles

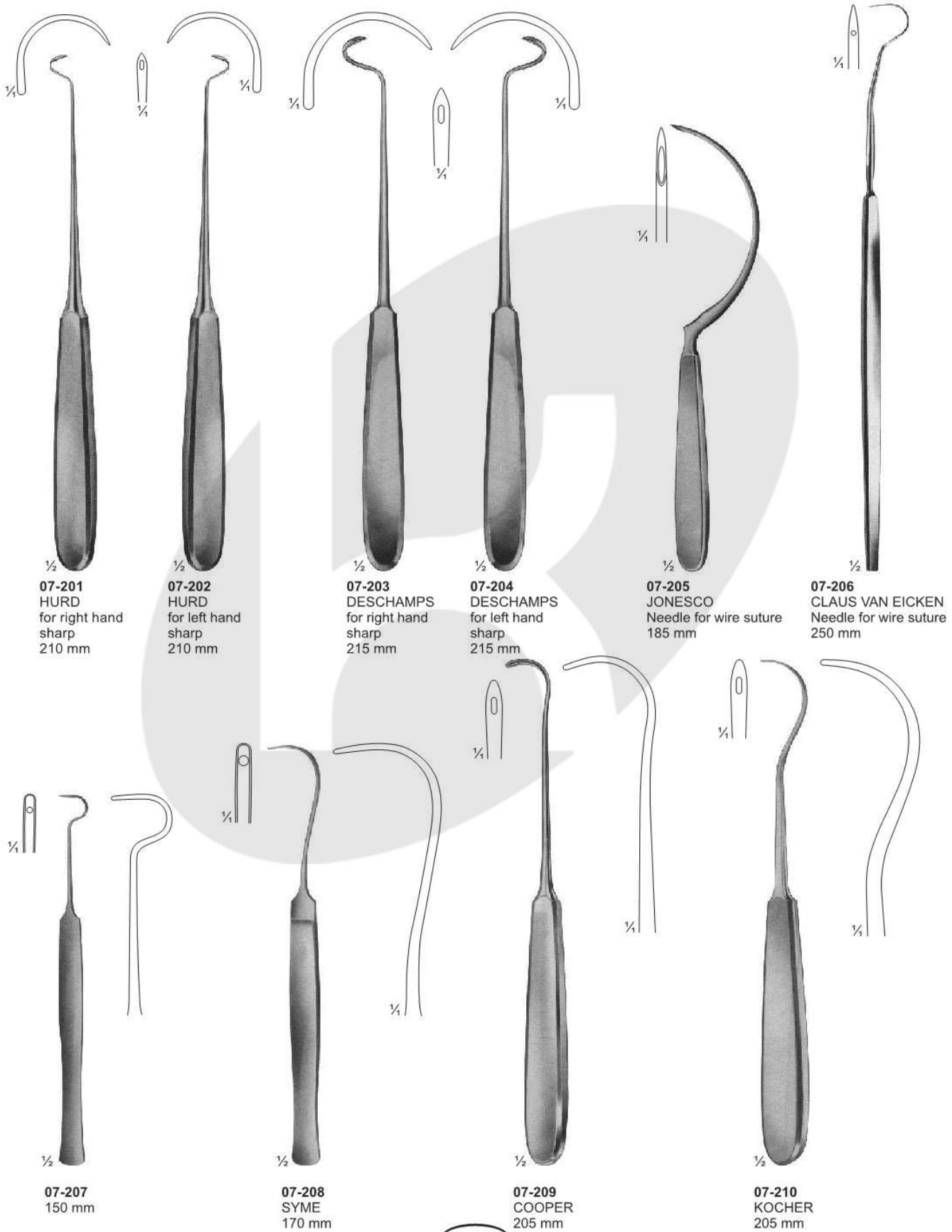

1/2
07-201
HURD
for right hand
sharp
210 mm

1/2
07-202
HURD
for left hand
sharp
210 mm

1/2
07-203
DESCHAMPS
for right hand
sharp
215 mm

1/2
07-204
DESCHAMPS
for left hand
sharp
215 mm

1/2
07-205
JONESCO
Needle for wire suture
185 mm

1/2
07-206
CLAUS VAN EICKEN
Needle for wire suture
250 mm

1/2
07-207
150 mm

1/2
07-208
SYME
170 mm

1/2
07-209
COOPER
205 mm

1/2
07-210
KOCHER
205 mm

Ligature Needles

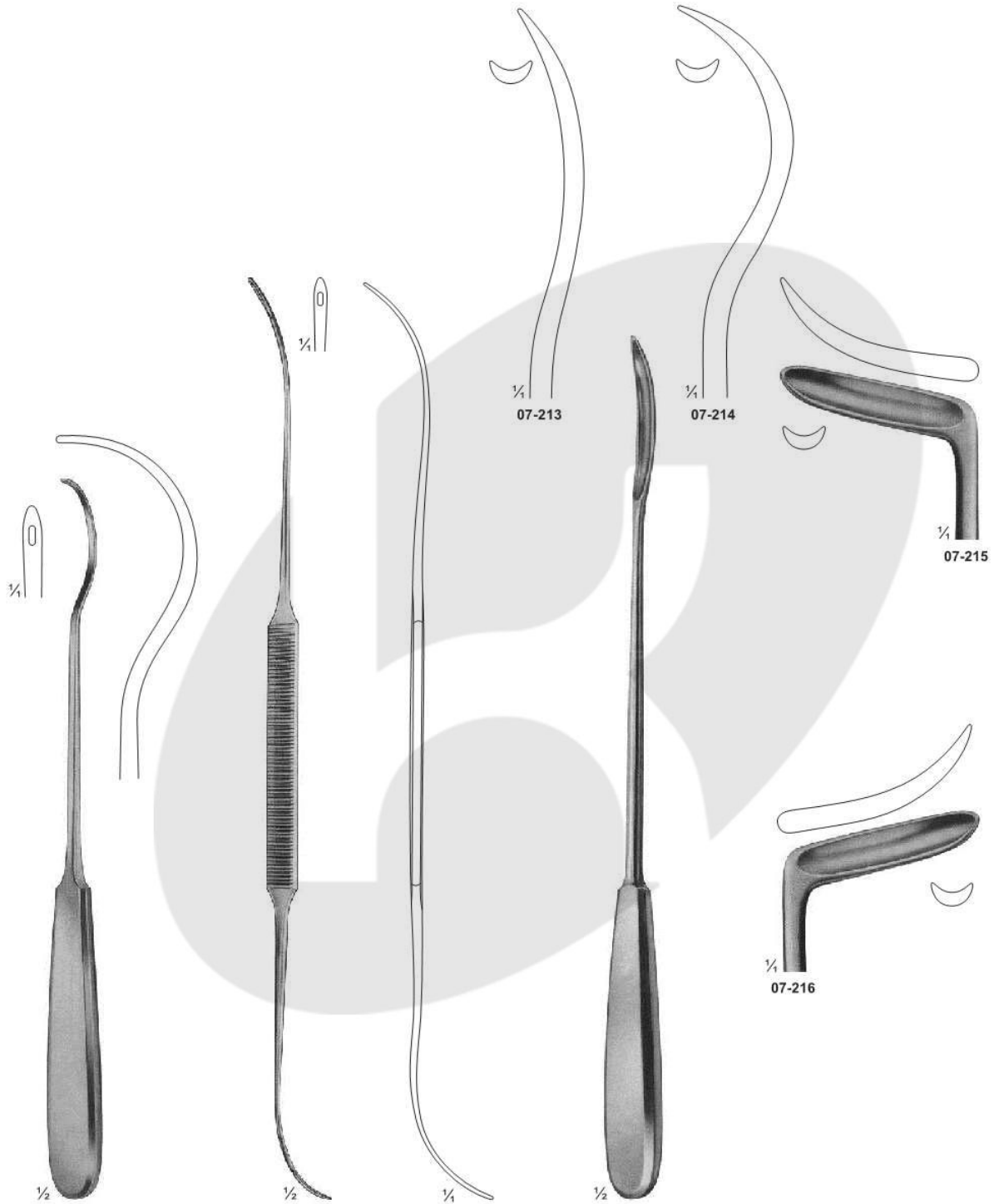

07-211
BRUNNER
240 mm

07-212
SCHMIEDEN-DICK
320 mm

07-213 - 216
BRUNNER
Guiding Probes
300 mm

Probes



07-242 145 mm
07-243 160 mm
07-244 200 mm
 Probes with eye

07-242
 2,5 mm
07-243
 2,5 mm
07-244
 3,0 mm



07-245
 Myrtle leaf probe
 145 mm

1,5 mm



07-246 130 mm
07-247 145 mm
07-248 160 mm
07-249 180 mm
07-250 200 mm

2,0 mm



07-251
 Probes



07-252 1/2
 Double ended probe,
 malleable, diam. of tips
 3 mm with hole
 190 mm



07-253
 Double ended probes,
 tin, malleable,
 diam. of tips
 3,5 mm with hole
 250 mm, 300 mm



07-254
 Double ended probes,
 tin, malleable,
 diam. of tips 4 mm
 400 mm



07-255 1,5 mm
07-256 2,0 mm
07-257 2,5 mm
 300 mm

1/3 \varnothing tip

Probes



07-242 145 mm
07-243 160 mm
07-244 200 mm
Probes with eye

07-242 2,5 mm
07-243 2,5 mm
07-244 3,0 mm



07-245
Myrtle leaf probe
145 mm



07-246 130 mm
07-247 145 mm
07-248 160 mm
07-249 180 mm
07-250 200 mm



07-251
Probes



07-252
Double ended probe,
malleable, diam. of tips
3 mm with hole
190 mm



07-253
Double ended probes,
tin, malleable,
diam. of tips
3,5 mm with hole
250 mm, 300 mm



07-254
Double ended probes,
tin, malleable,
diam. of tips 4 mm
400 mm



07-255 1,5 mm
07-256 2,0 mm
07-257 2,5 mm
300 mm

Probes - Spatulas - Cotton Applicators

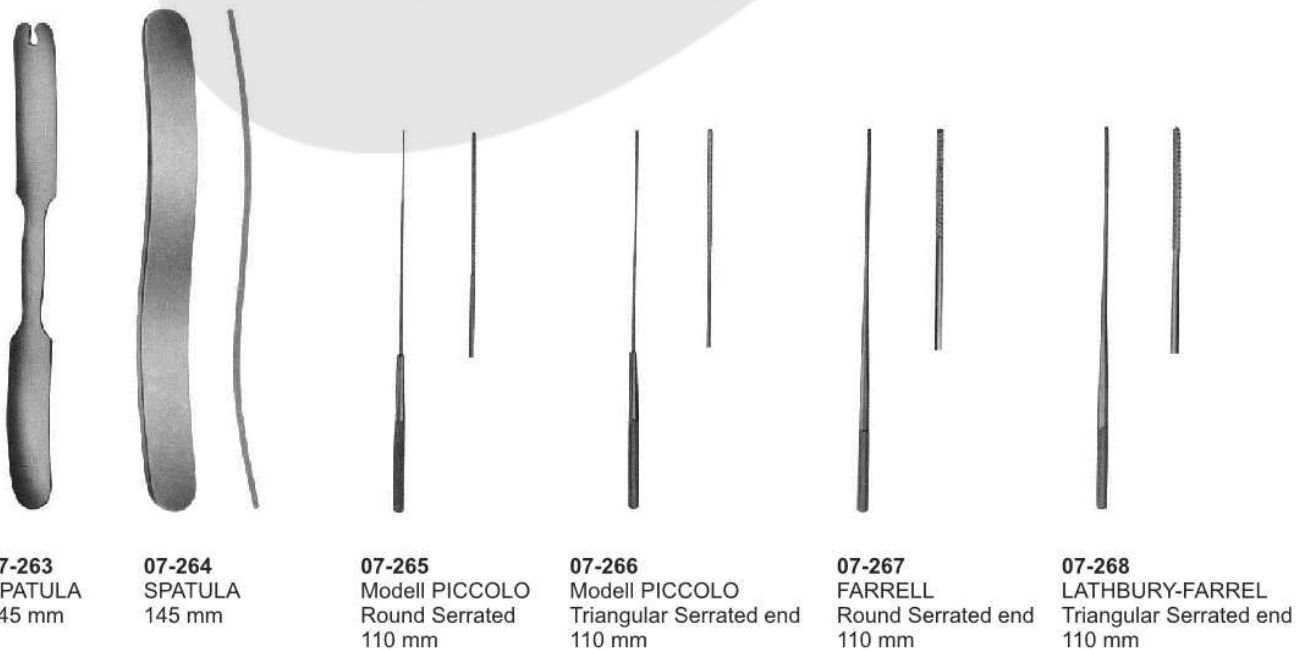
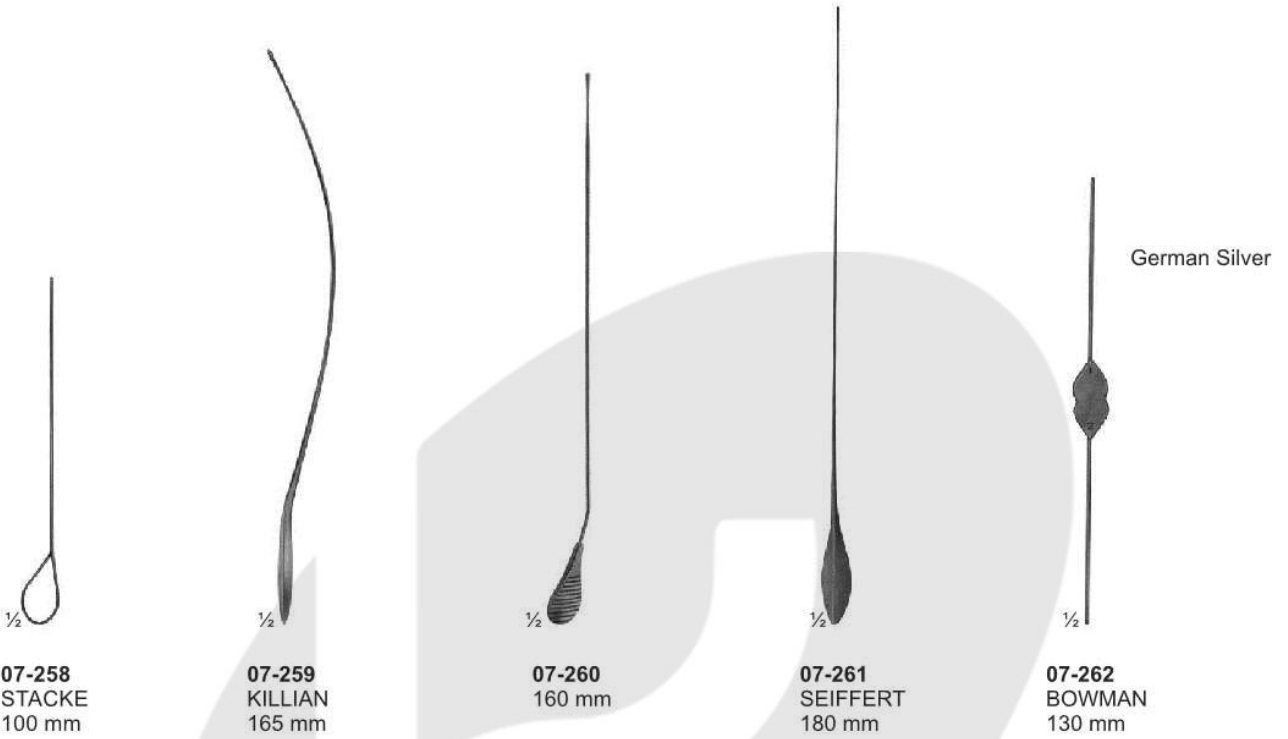

Cotton Applicators



07-269
BUCK
Rough, spiral end
120 mm

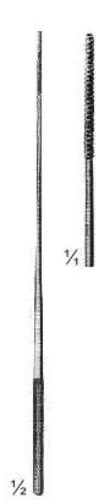

07-270
Triangular
serrated end
140 mm



07-271
Rough, spiral end
140 mm



07-272
Rough, spiral end
140 mm



07-273
Rough, spiral end
140 mm



07-274
FARRELL
Round,
serrated end
140 mm



07-275
LATHBURY-FARRELL
Triangular,
serrated end
140 mm



07-276
FARRELL
Rough,
spiral end
160 mm



07-277
LATHBURY-FARRELL
Triangular,
serrated end
160 mm



07-278
Triangular,
serrated end
160 mm



07-279
Rough,
spiral end
180 mm



07-280
Rough,
spiral end
180 mm



07-281
Rough,
spiral end
270 mm

Clip Applying Forceps - Suture Set



07-282
MICHEL
125 mm



07-283
HEGENBARTH
120 mm



07-284
WACHENFELDT
120 mm



07-285
WACHENFELDT
120 mm



07-286
MICHEL
125 mm



07-287
MICHEL modif.
130 mm



07-288
HEATH
135 mm

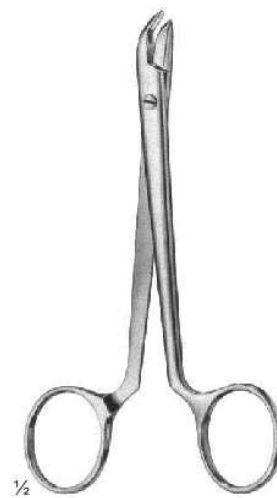

07-289
COLLIN
135 mm

Clip Applying Forceps - Suture Set



07-290

Suturing instruments set, in metal case consisting of: Scissors, curved, sharp/sharp, 115mm
25 MICHEL clip, 16 x 3mm
1 Delicate tissue forceps, 130mm
1 Scalpel, bellied
1 MATHIEU needle holder, 140mm
1 Perforated metal case, stainless containing:
1 Suture needle
1 item 1 item



07-291

Pocket instrument set, in metal case consisting of:

Bottom tray

1 MATHIEU needle holder, 140mm
1 MICHEL clip forceps, combined
1 Myrtle leaf probe, 130mm
1 Sharp double curette
1 Skin hook
1 Detachable scalpel handle, no.4
1 Perforated metal case, containing
6 Scalpel blades BB 520
1 Perforated metal case, stainless, containing
1 Suture needle
1 item
1 item

Top tray

1 Tissue forceps, 130mm
1 KOCHER haemostatic forceps, 130mm
1 Straight surgical scissors, 130mm
1 Dissecting forceps, 130mm
1 FEILCHENFELD splinter forceps, 115mm
25 MICHEL clip, 16 x 3mm
1 Flacon of suture skin, sterile in alcohol

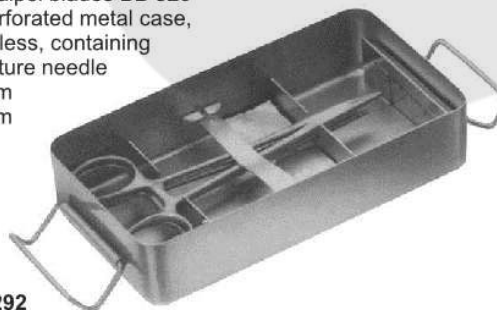
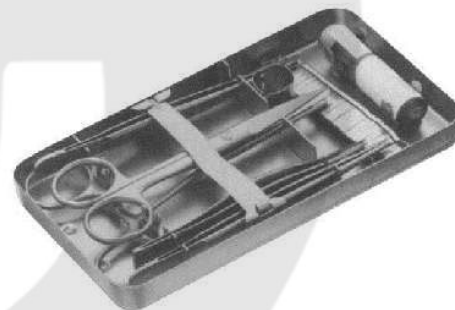

07-292

Pocket instrument set, in metal case consisting of:

Bottom tray

1 MAYO-HEGER needle holder, 150mm
1 MICHEL clip forceps, combined
1 Myrtle leaf probe, 130mm
1 Sharp double curette
1 Skin hook
1 Detachable scalpel handle, no. 4
1 Perforated metal case, consisting
6 Scalpel blades BB 520
1 Perforated metal case, stainless, consisting:
1 Suture needle
1 item, & 1 item

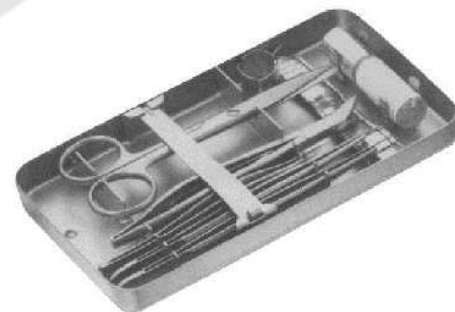

Bottom tray

1 Tissue forceps, 130mm
1 CRILE haemostatic forceps, 140mm
1 Straight surgical scissors, 130mm
1 Dissecting forceps, 130mm
1 FEILCHENFELD splinter forceps, 115mm
25 MICHEL clip, 16 x 3mm
1 Flacon of suture silk, sterile in alcohol

Clip Applying Forceps - Suture Set

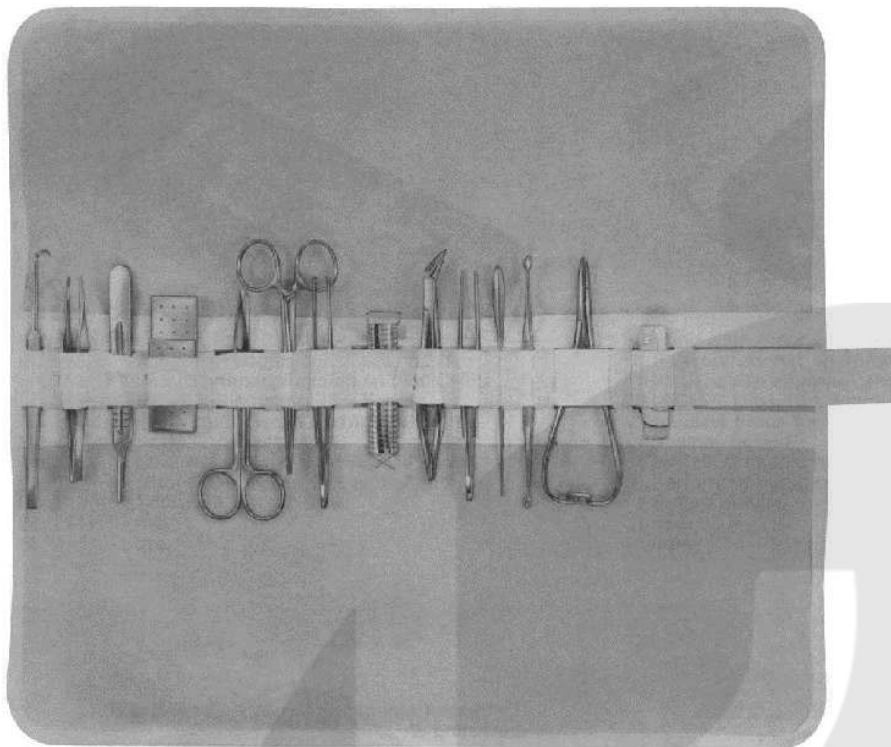

07-293

Pocket instrument set in metal case 170 x 90mm with sterilizable canvas roll consisting of:

- 1 Myrtle leaf probe, 130mm
- 1 Sharp double curette
- 1 FEILCHENFELD splinter forceps, 115mm
- 1 Dissecting forceps, 130mm
- 1 Tissue forceps, 130mm

- 1 Straight surgical scissors, 130mm
- 1 Scalpel handle no. 4
- 1 Perforated metal case, consisting of 6 scalpel blades BB 520
- 1 KOCHER haemostatic forceps, 130mm
- 1 Skin hook
- 1 MATHIEU needle holder, 140mm
- 1 Tube of suture skin, sterile in alcohol
- 1 MICHEL clip forceps, 120mm

- 25 MICHEL clip, 16 x 3mm
- 1 Perforated metal case, stainless, consisting of:
- 1 Suture needle
- 1 item
- 1 item

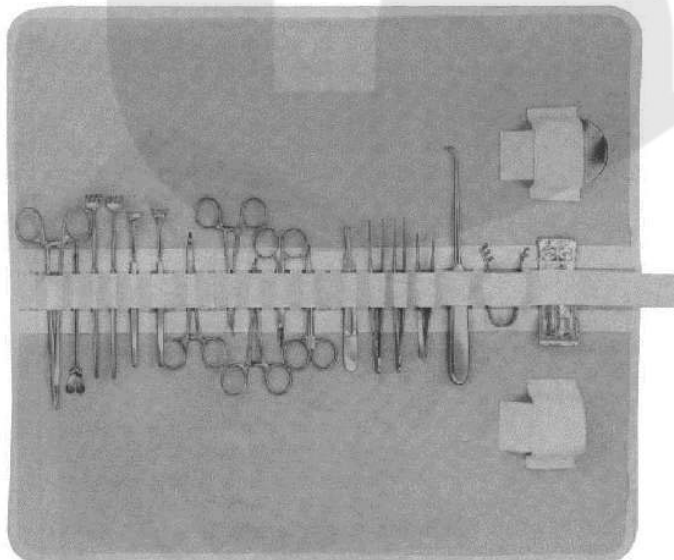

07-294

Venae sectio set, in sterilizable canvas roll consisting of:

- 1 Tissue forceps, 1 x 2 teeth, 140mm
- 1 Dissecting forceps, 145mm
- 1 FEILCHENFELD straight scissors, sharp, 110mm
- 1 curved scissors, blunt, 115mm
- 1 HALSTED mosquito forceps, curved on flat, 125mm

- 1 DESCHAMPS needle, blunt, 210mm
- 1 DOYEN Director, curved, 140mm
- 2 Wound retractors, 4 blunt prongs, 160mm
- 2 DESMARRES wound retractors, 135mm
- 1 FINSSEN retractors, 2 x3 blunt prongs, 80mm

- 1 Scalpel handle no. 4
- 4 Sterile scalpel blades, no 18, single peel pack
- 1 Needle box, perforated, round, diam. 65mm
- 1 HEGAR-MAYO DUROGRIP needle holder, 180mm



Clip Applying Forceps - Suture Set

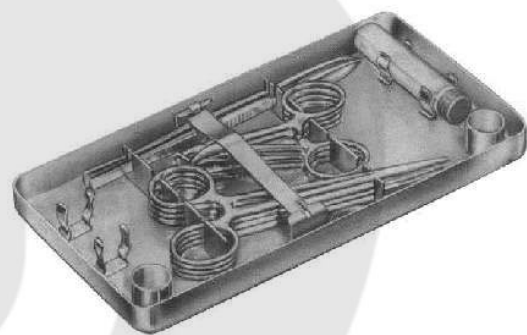
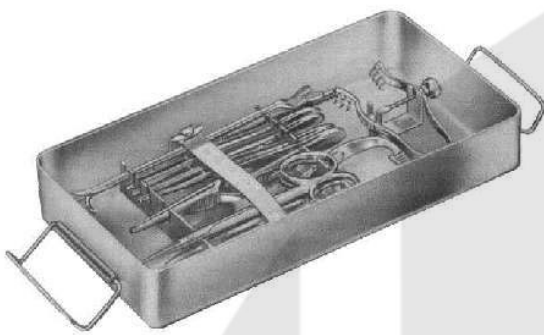

07-295

Venae sectio set, in metal case
consisting of:

Bottom tray

- 1 MATHIEU needle holder, fine pattern 140mm
- 1 Ligature needle, fine short pattern
- 1 DOYEN director, curved
- 1 HEGENBARTH clip forceps,
- 1 ELSCHNIG tissue forceps, 1 x 2 teeth fine, 150mm
- 1 Dressing forceps, fine 105mm
- 1 Tissue forceps, 1 x 2 teeth, 110mm
- 1 Vessel scissors, straight, with 1 ball point, 110mm
- 1 Vessel scissors, curved, pointed 105mm
- 1 FINSSEN retractor
- 1 Perforated needle case

Top tray

- 1 Scalpel, pointed
- 1 Scalpel, bellied
- 2 HALSTED mosquito forceps, curved, 125mm
- 2 HALSTED mosquito forceps, straight, 1x 2 teeth, 125mm
- 3 BACKHAUS towel forceps, 90mm
- 2 Flacon holder

Nerve - and Vessel Hooks

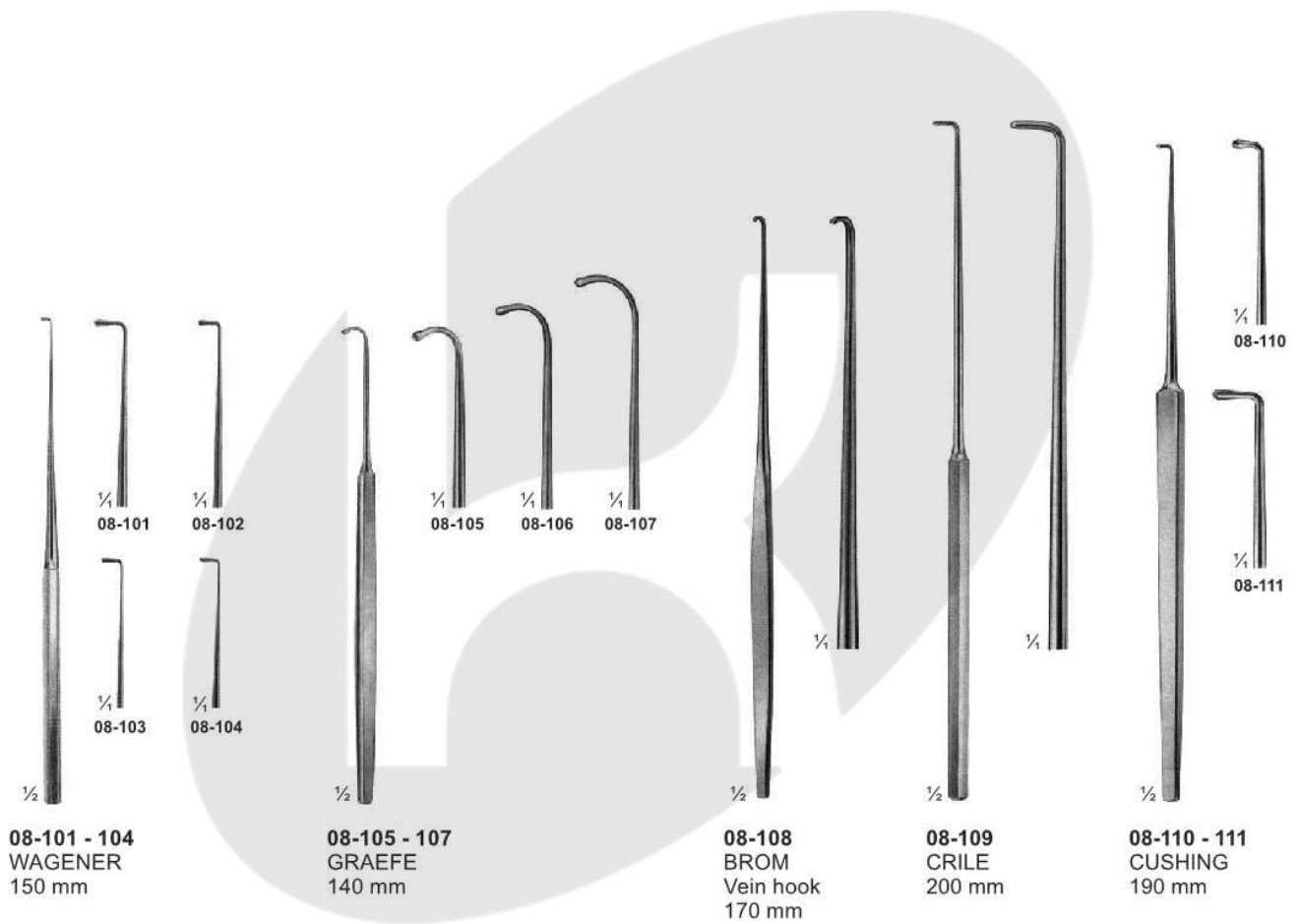

Nerve - and Vessel Hooks

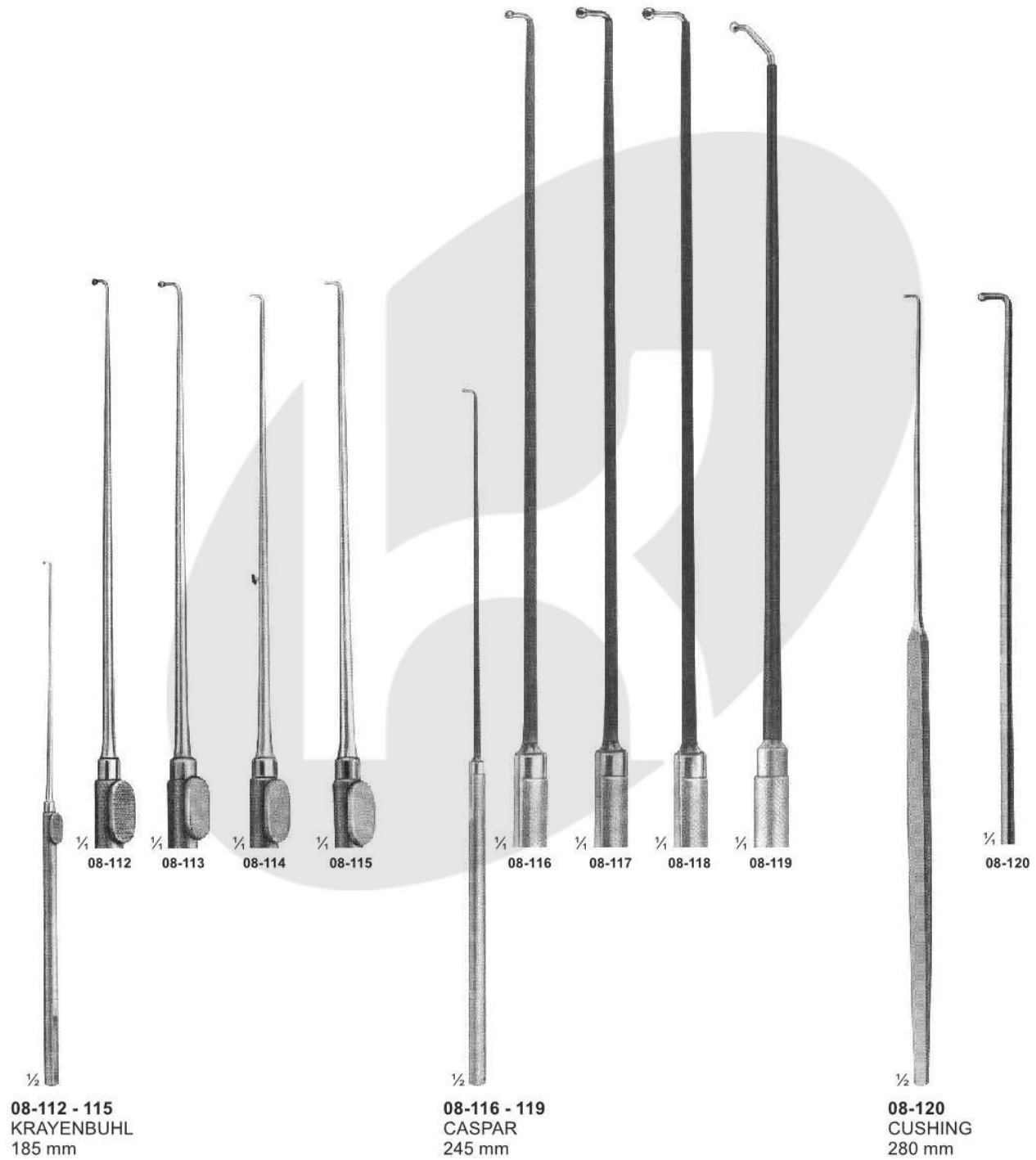

Fine Wound Retractors (Dura- and Skin Retractors)

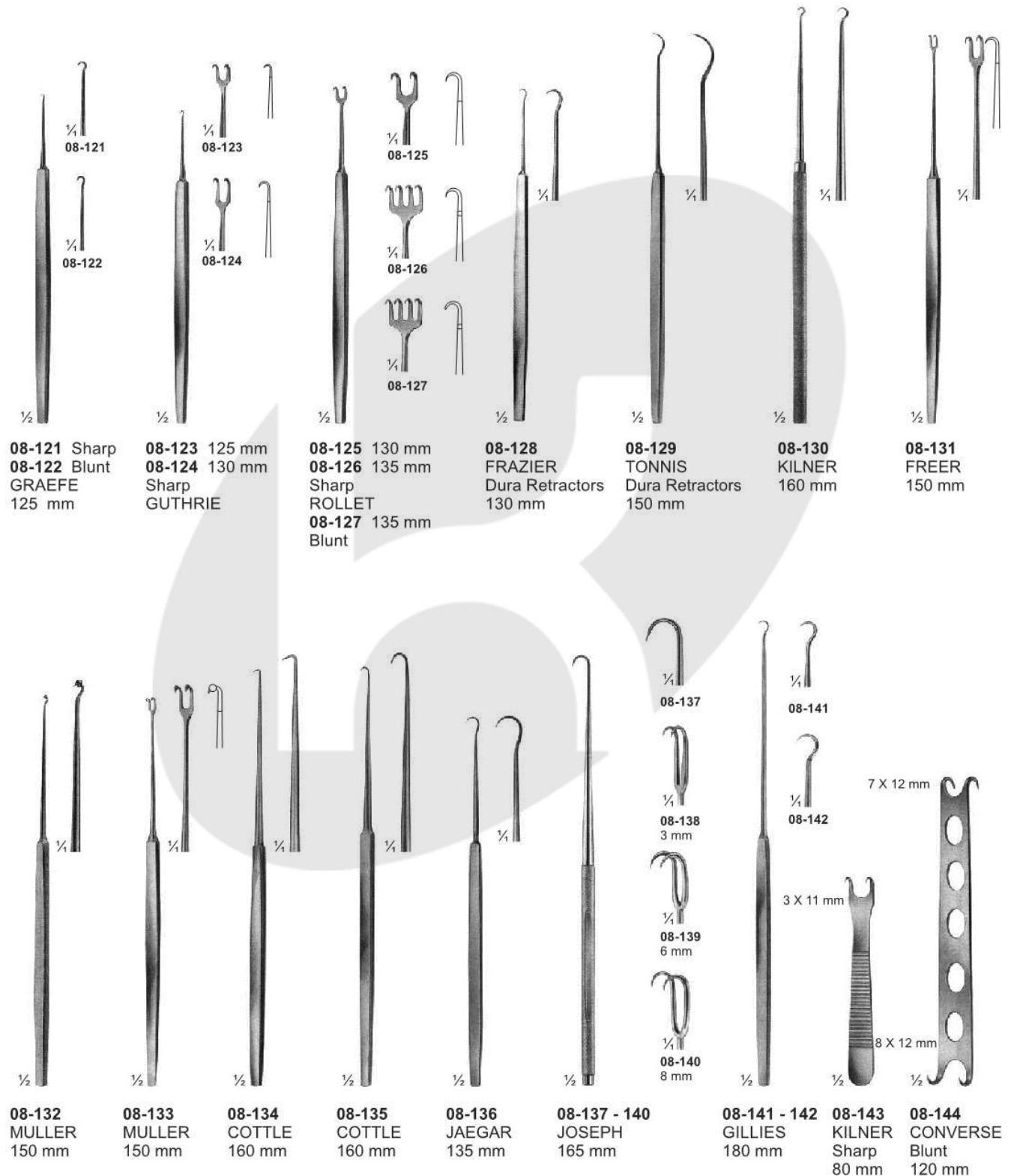

Wound - Trachea Retractors

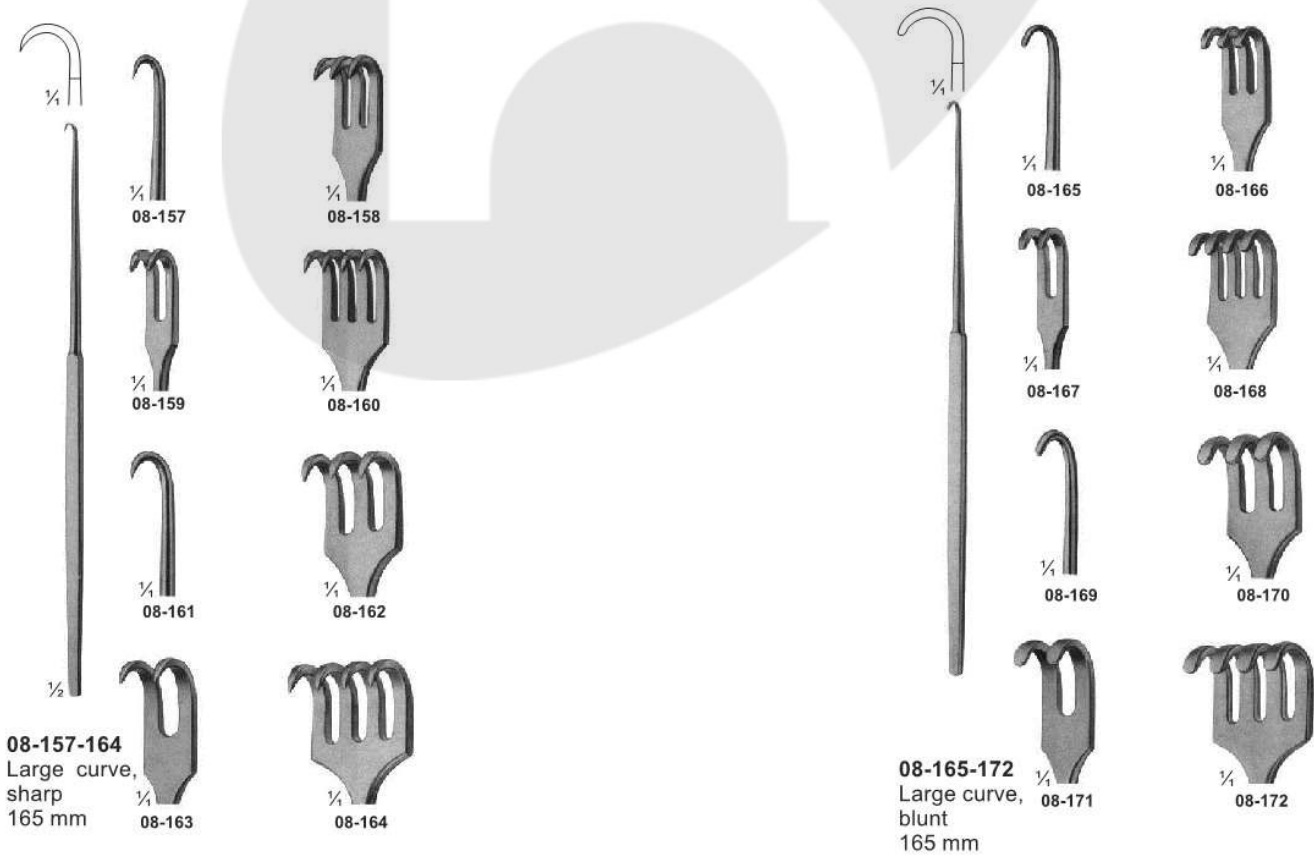
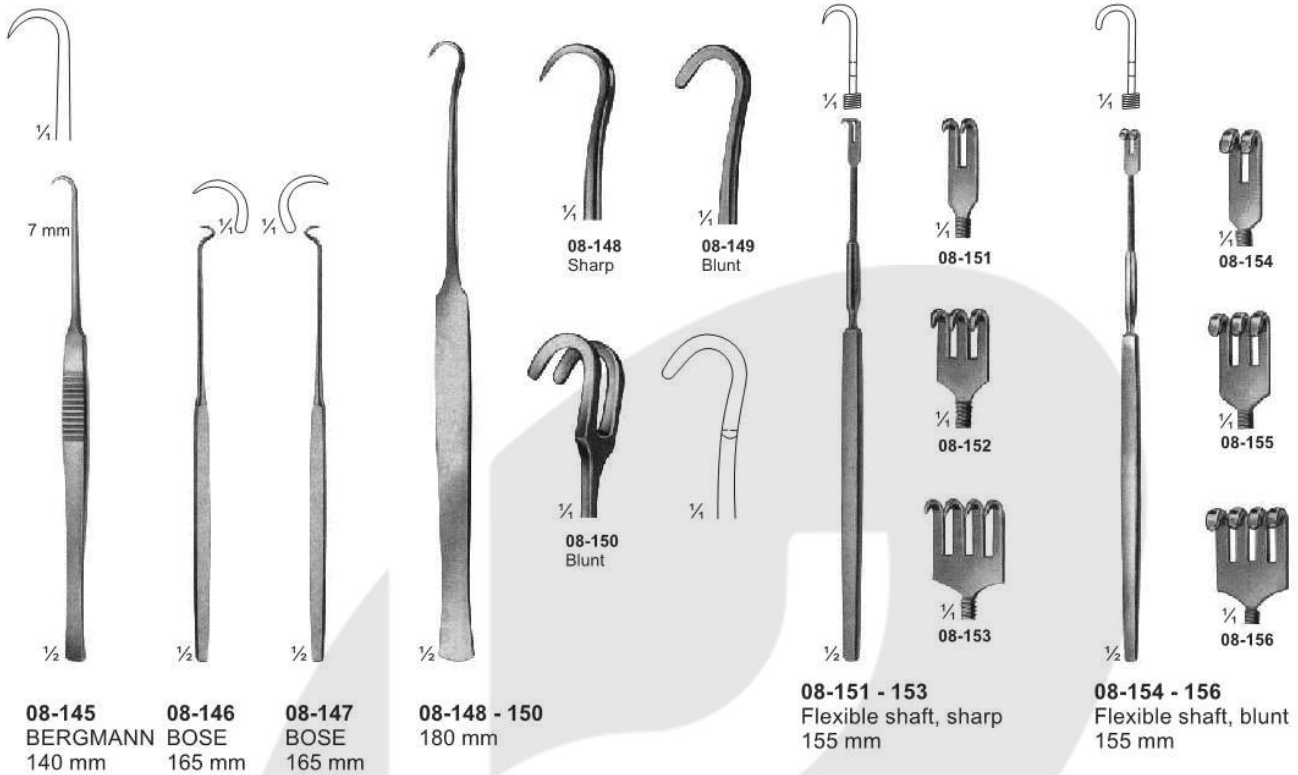

Retractors With Treangle Handle

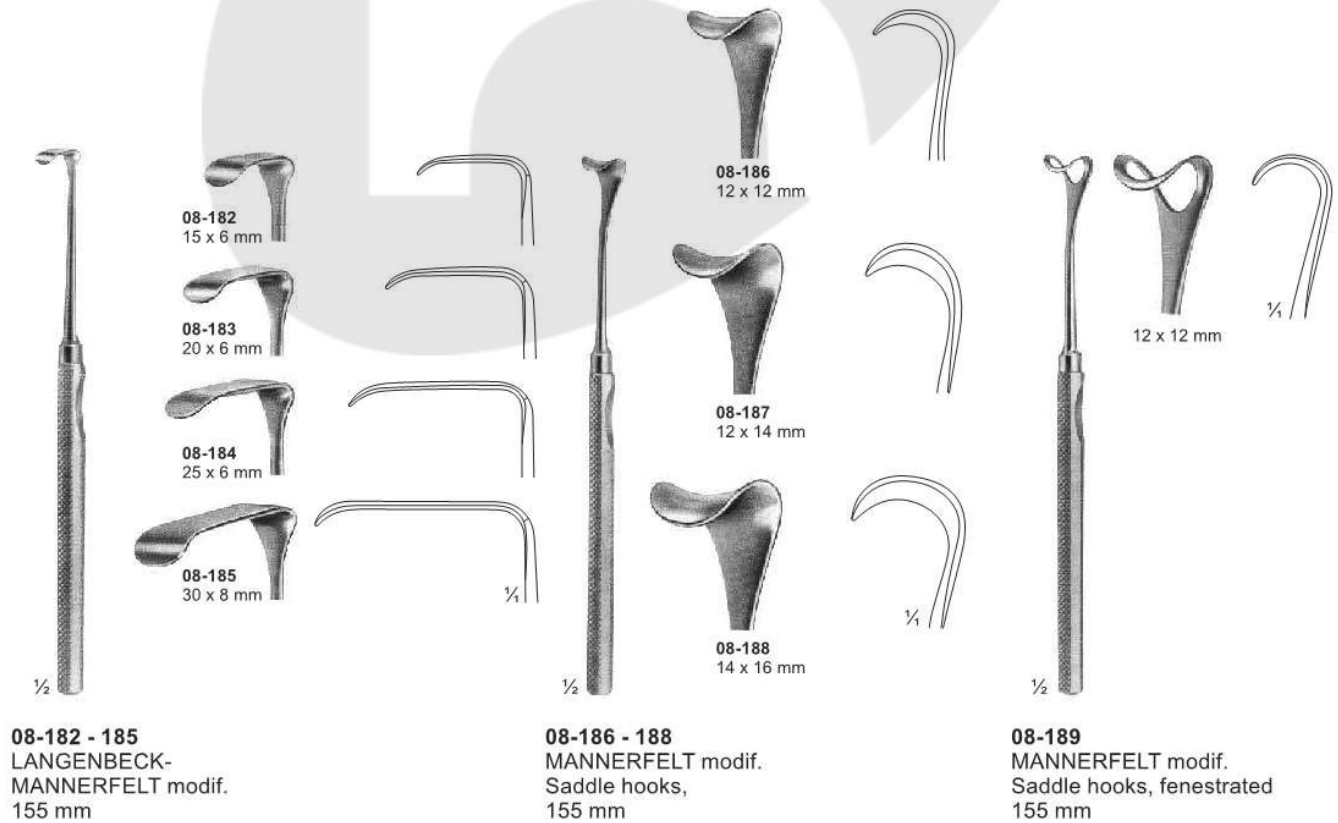
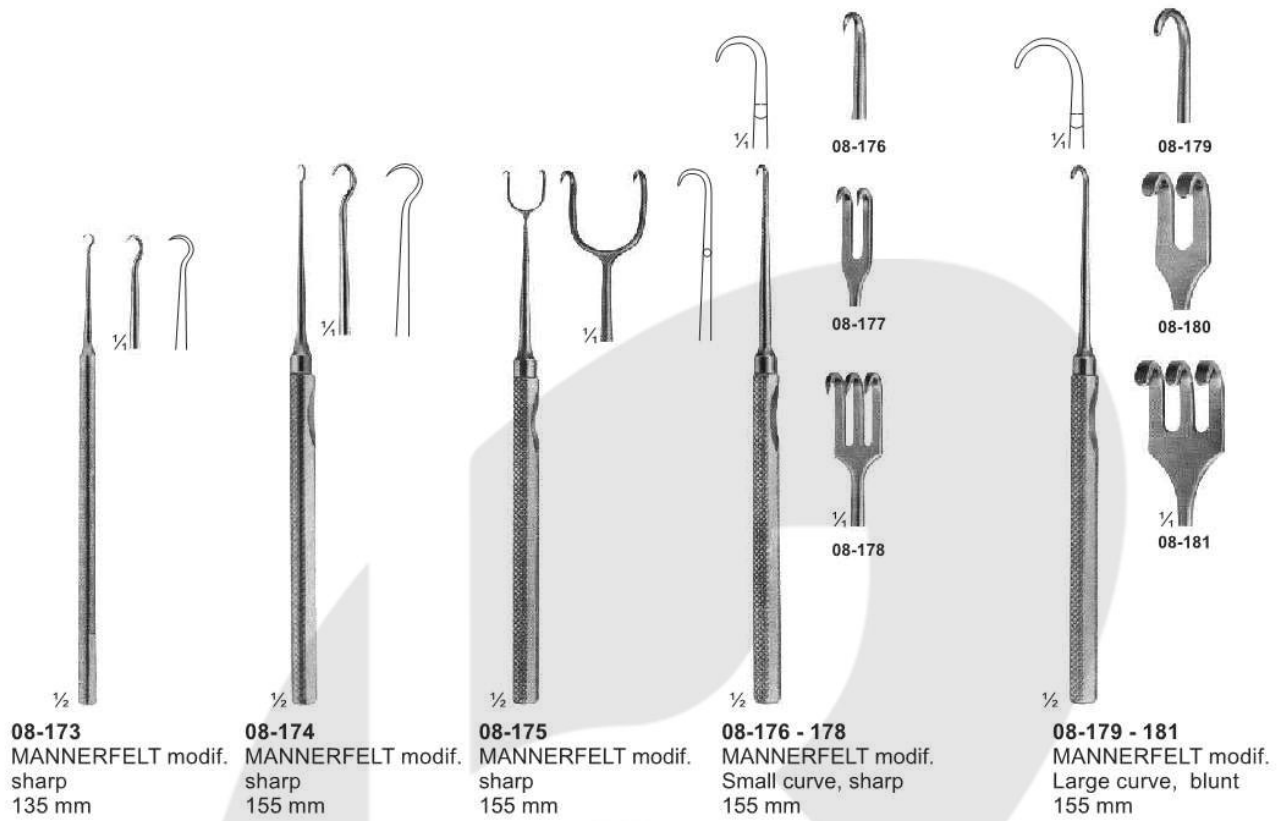

Retractors

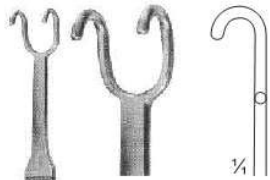

08-190
FOMON
145 mm

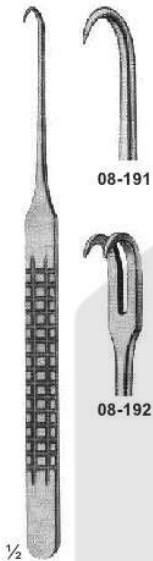

08-191 - 192
160 mm

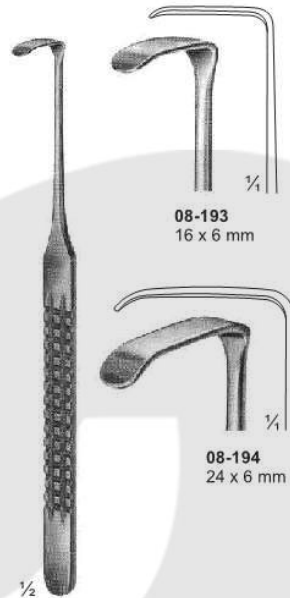

08-193 - 194
LANGENBECK-GREEN
160 mm

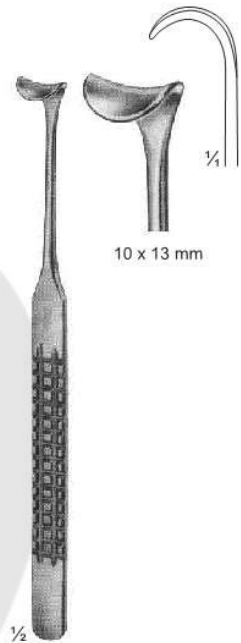

08-195
160 mm

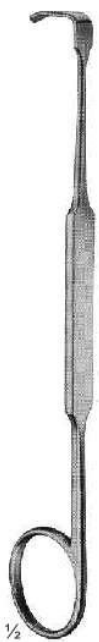

08-196 - 201
MEYERDING
Fig. A - Fig. F
180 mm

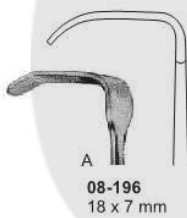

A
08-196
18 x 7 mm

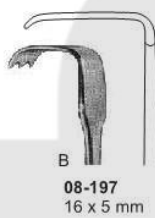

B
08-197
16 x 5 mm

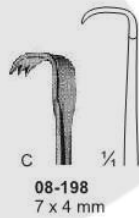

C
08-198
7 x 4 mm

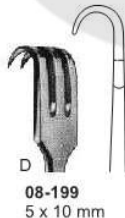

D
08-199
5 x 10 mm



E
08-200
11 x 4 mm



F
08-201
6 x 4 mm

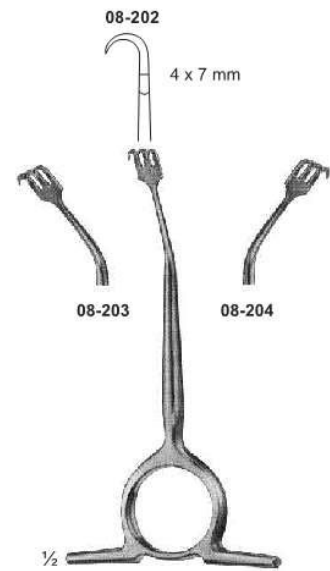

08-202
4 x 7 mm

08-203

08-204

08-202 - 204
WILLIGER
120 mm

Retractors



08-205
EMMET
Fistula hook
220 mm

08-206
SIMON
Fistula hook
220 mm

08-207
SIMON
Fistula hook
220 mm

08-208
LANGE
Fistula hook
230 mm

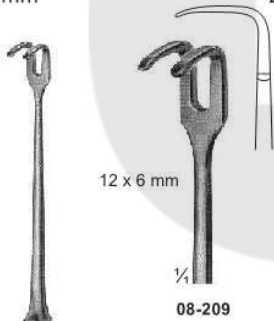

12 x 6 mm

1/4

08-209

12 x 11 mm

1/4

08-210

08-209 - 210
Tendon hooks
175 mm

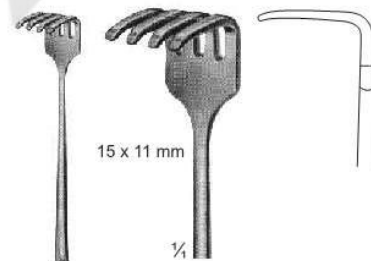

15 x 11 mm

1/4

08-211
KLAPP
Tendon hooks
175 mm

Retractors

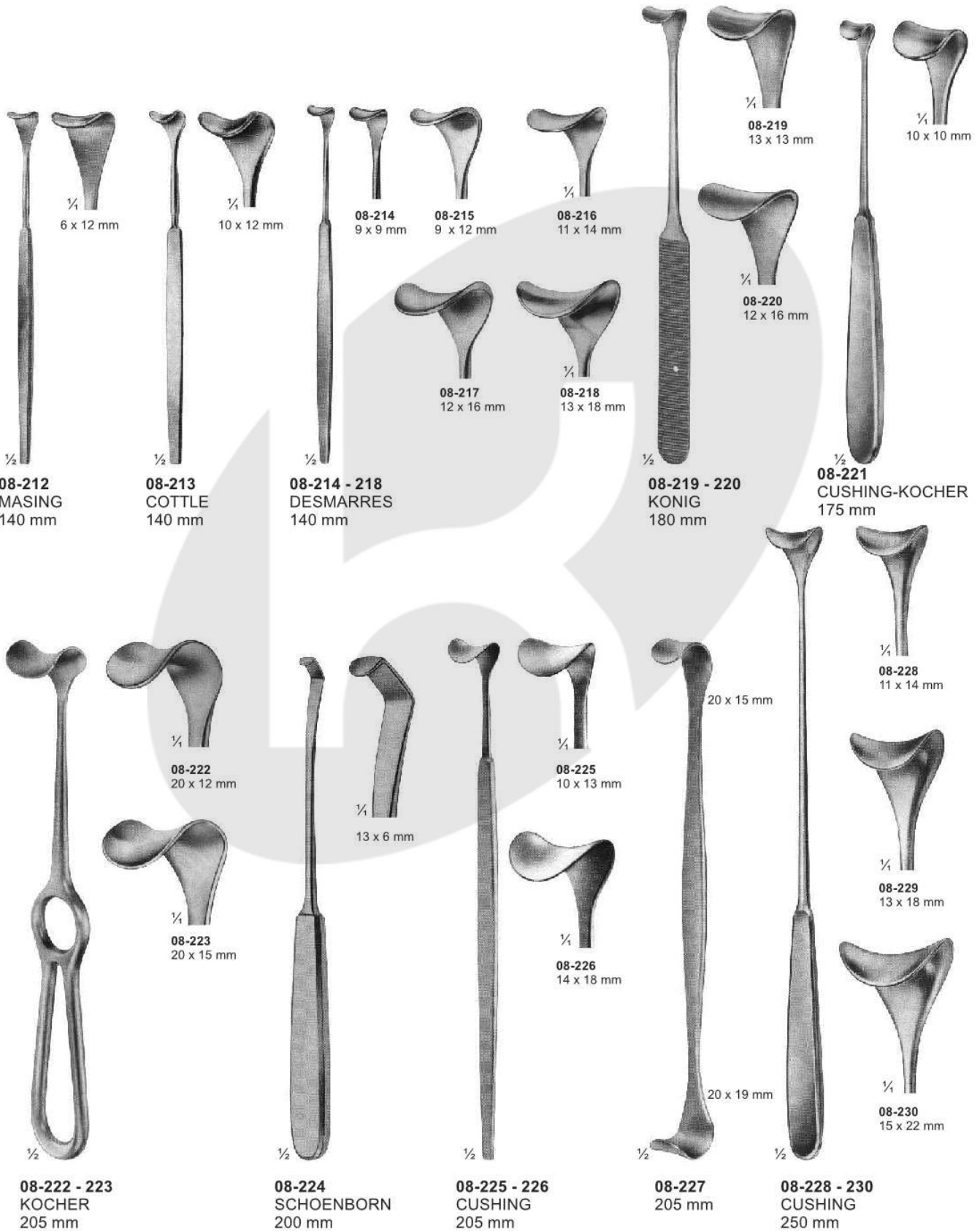

Retractors

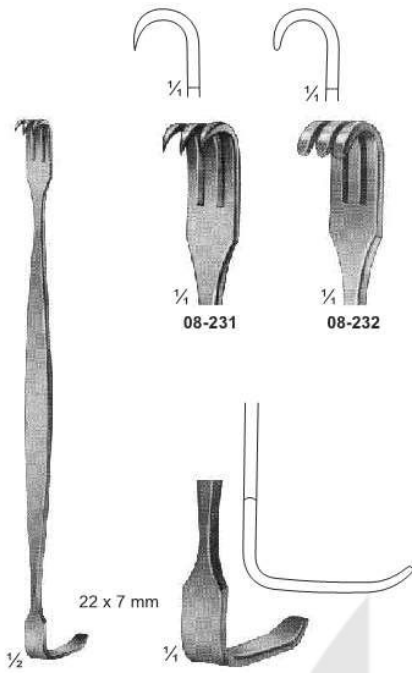

08-231 - 232
BABY-SENN-MILLER
155 mm

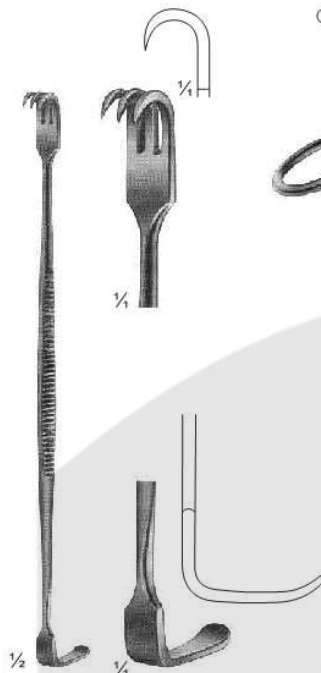

08-233
SENN-MILLER
165 mm

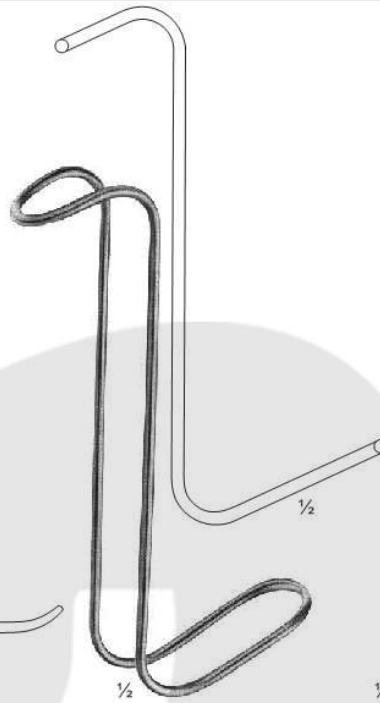

08-234
COLLIN-HARTMANN
150 mm

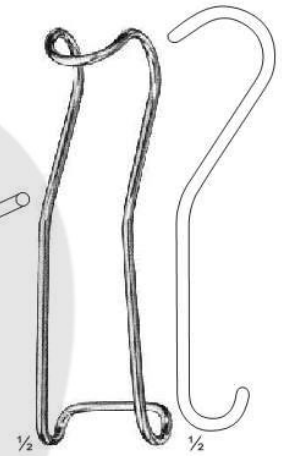

STERBERG
08-235 120 mm
08-236 130 mm
08-237 135 mm
08-238 140 mm

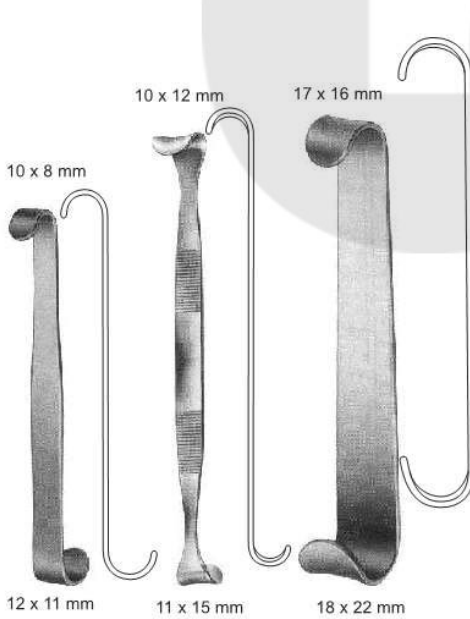

08-239
LUER
110 mm

08-240
ROSE
130 mm

08-241
BABY-ROUX
135 mm

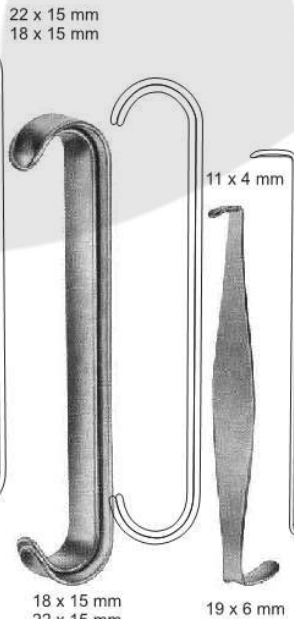

08-242
PARKER
135 mm

08-243
CRILE
110 mm

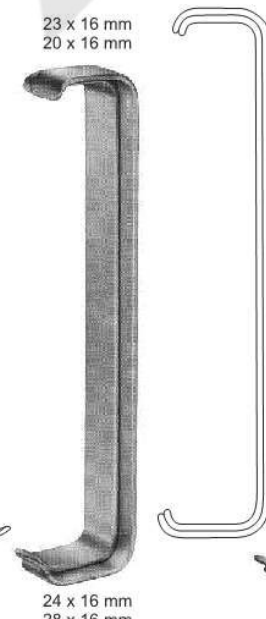

08-244
FARABEUF
150 mm

08-245
COLLIN
150 mm

Retractors

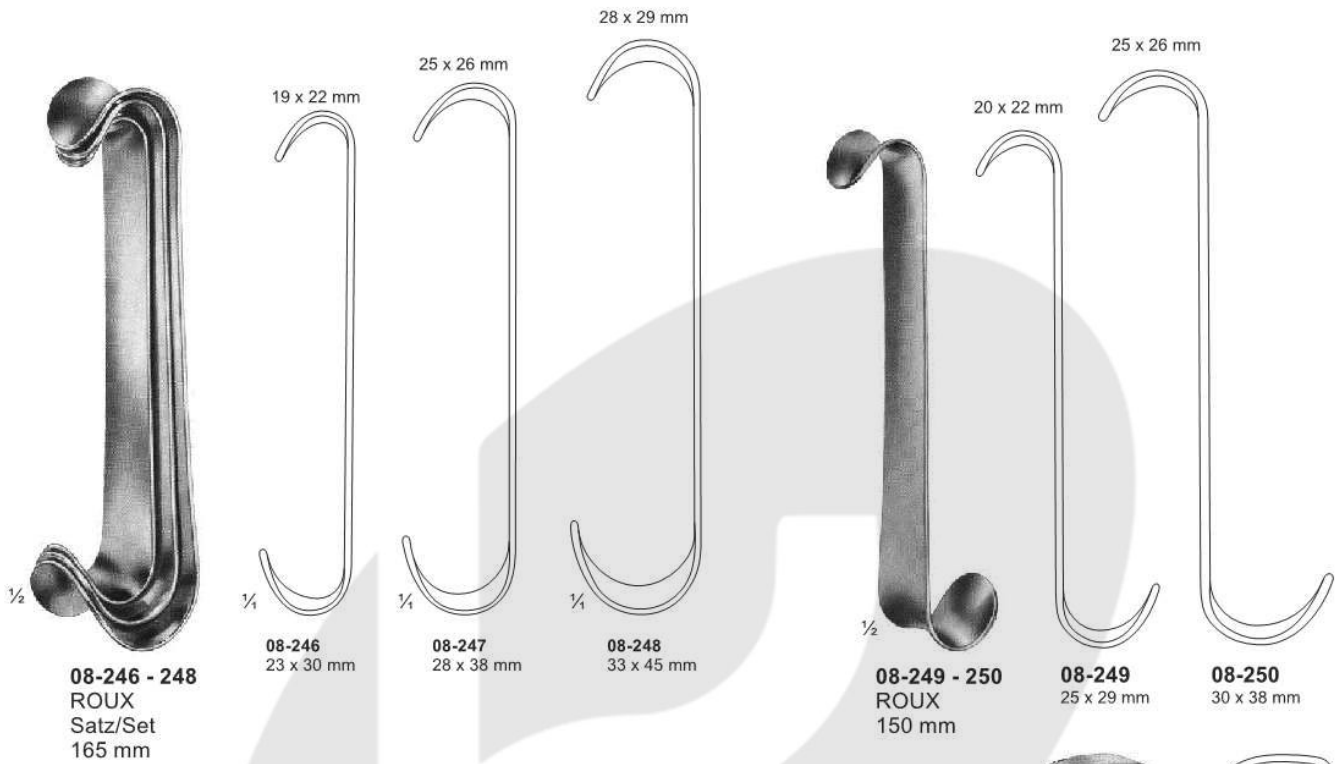

Bone Retractors and Retractors

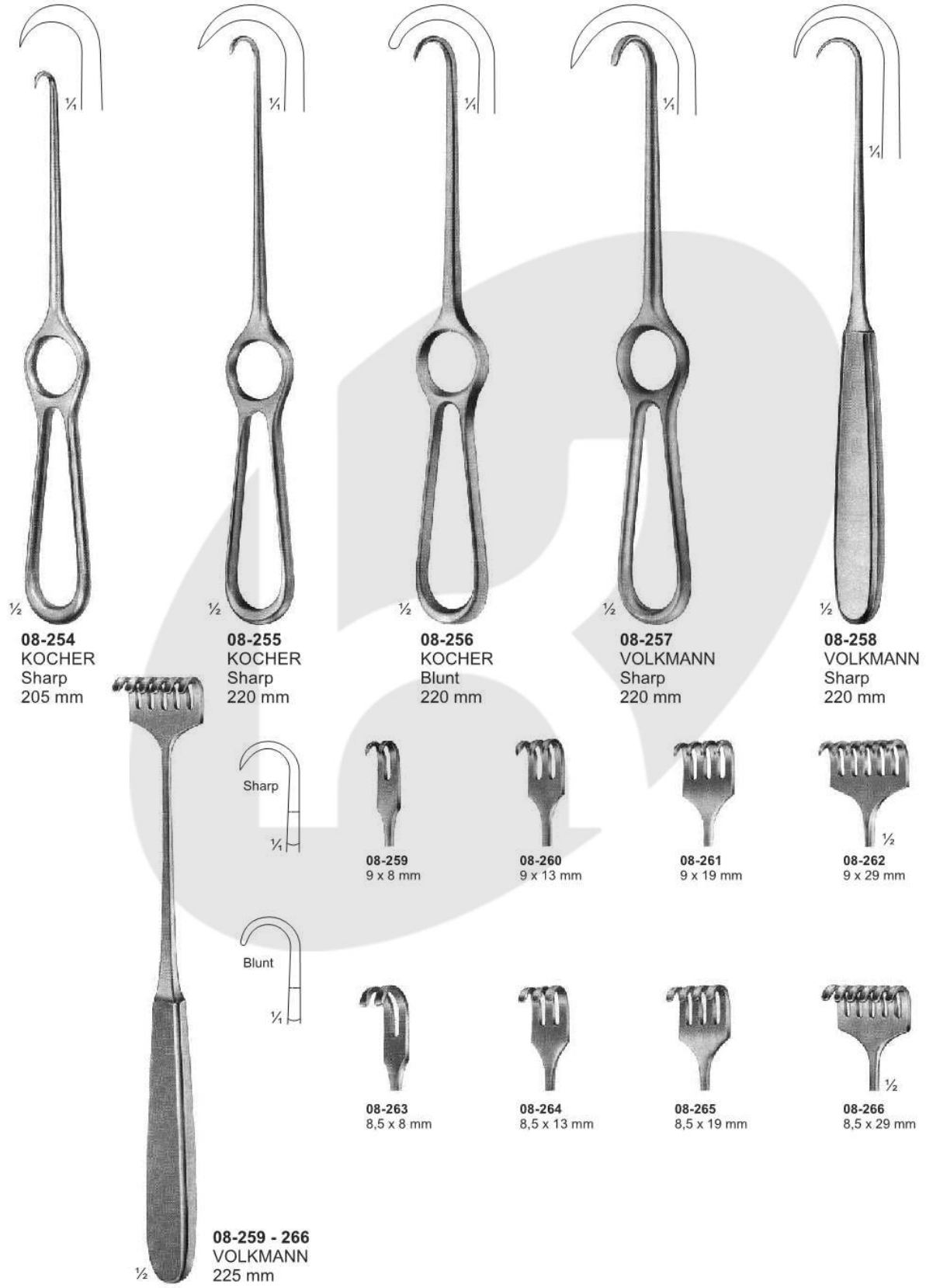

Retractors

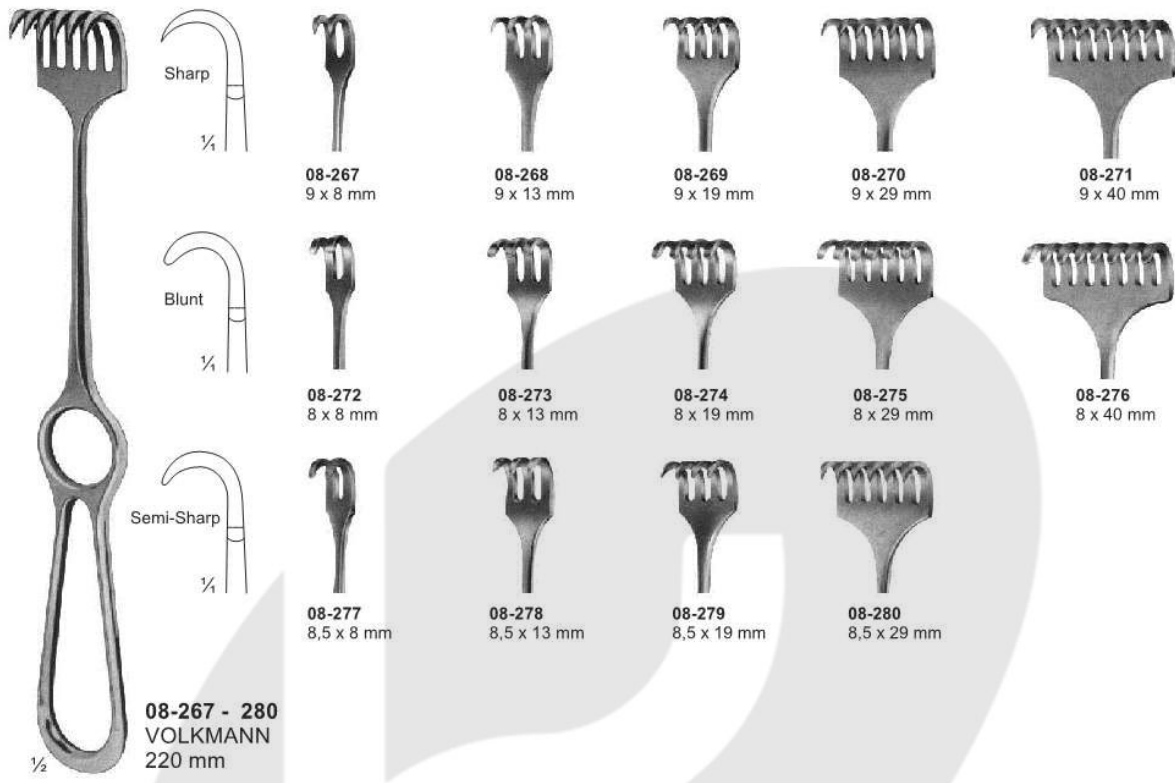

Retractors, Deep form

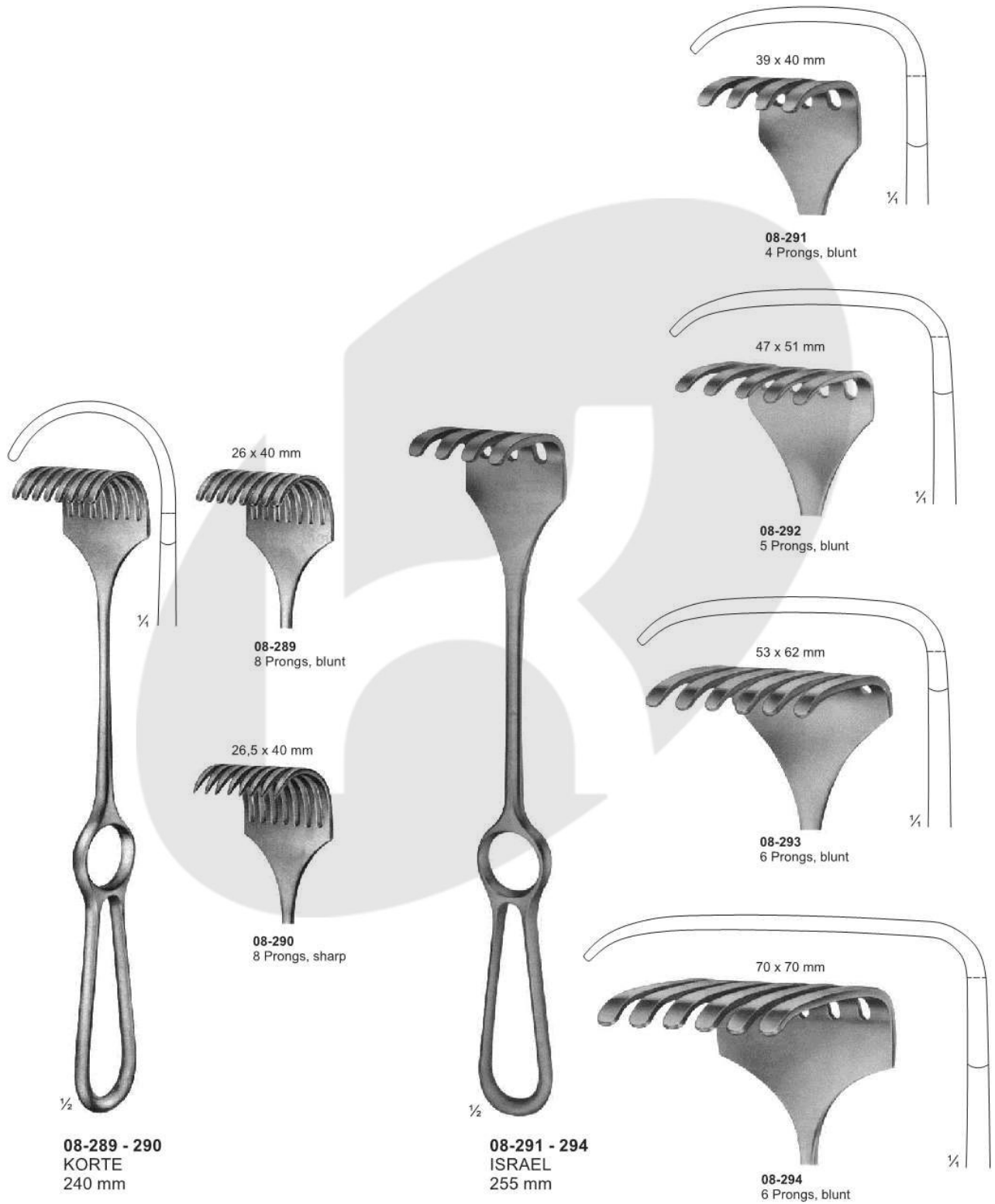

Retractors



08-295 - 300
LANGENBECK
 210 mm
08-295 28 x 10 mm
08-296 28 x 14 mm
08-297 33 x 14 mm
08-298 28 x 16 mm
08-299 40 x 10 mm
08-300 40 x 13 mm

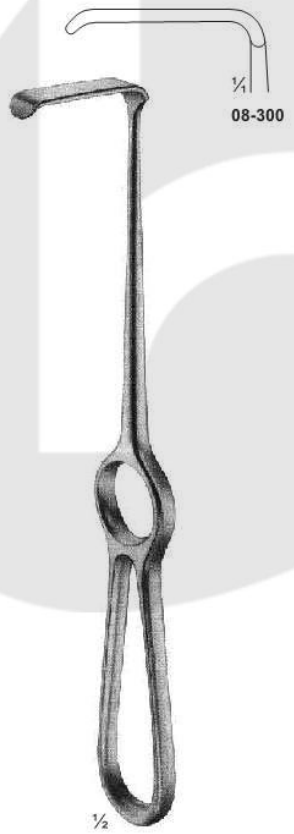

08-301 - 307
KOCHER-LANGENBECK
 215 mm
08-301 25 x 6 mm
08-302 35 x 8 mm
08-303 35 x 11 mm
08-304 35 x 15 mm
08-305 41 x 11 mm
08-306 55 x 11 mm
08-307 70 x 14 mm



Handle vertical to the Blade

08-308
LANGENBECK
 215 mm

Retractors



08-309 - 313
KOCHER
 230 mm

1/2



08-314 - 316
SAUERBRUCH
 225 mm

1/2

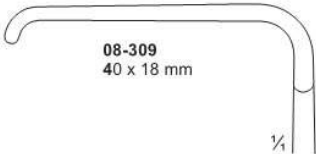

08-309
 40 x 18 mm

1/4

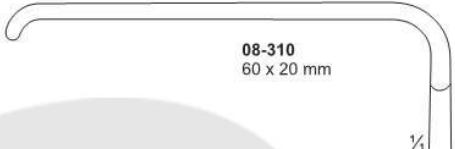

08-310
 60 x 20 mm

1/4

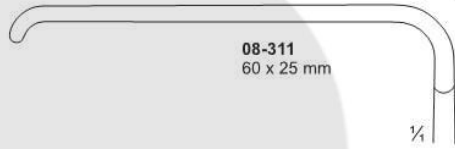

08-311
 60 x 25 mm

1/4



08-312
 75 x 30 mm

1/4



08-313
 75 x 40 mm

1/4

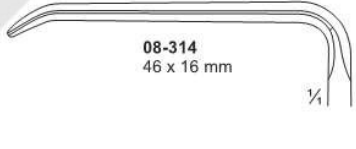

08-314
 46 x 16 mm

1/4

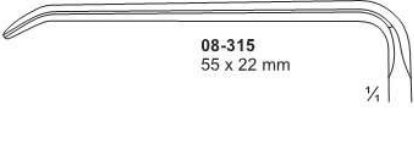

08-315
 55 x 22 mm

1/4

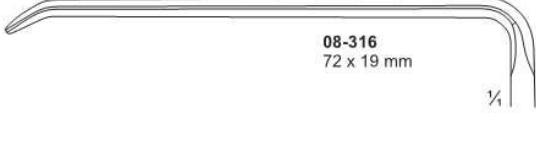

08-316
 72 x 19 mm

1/4

Retractors

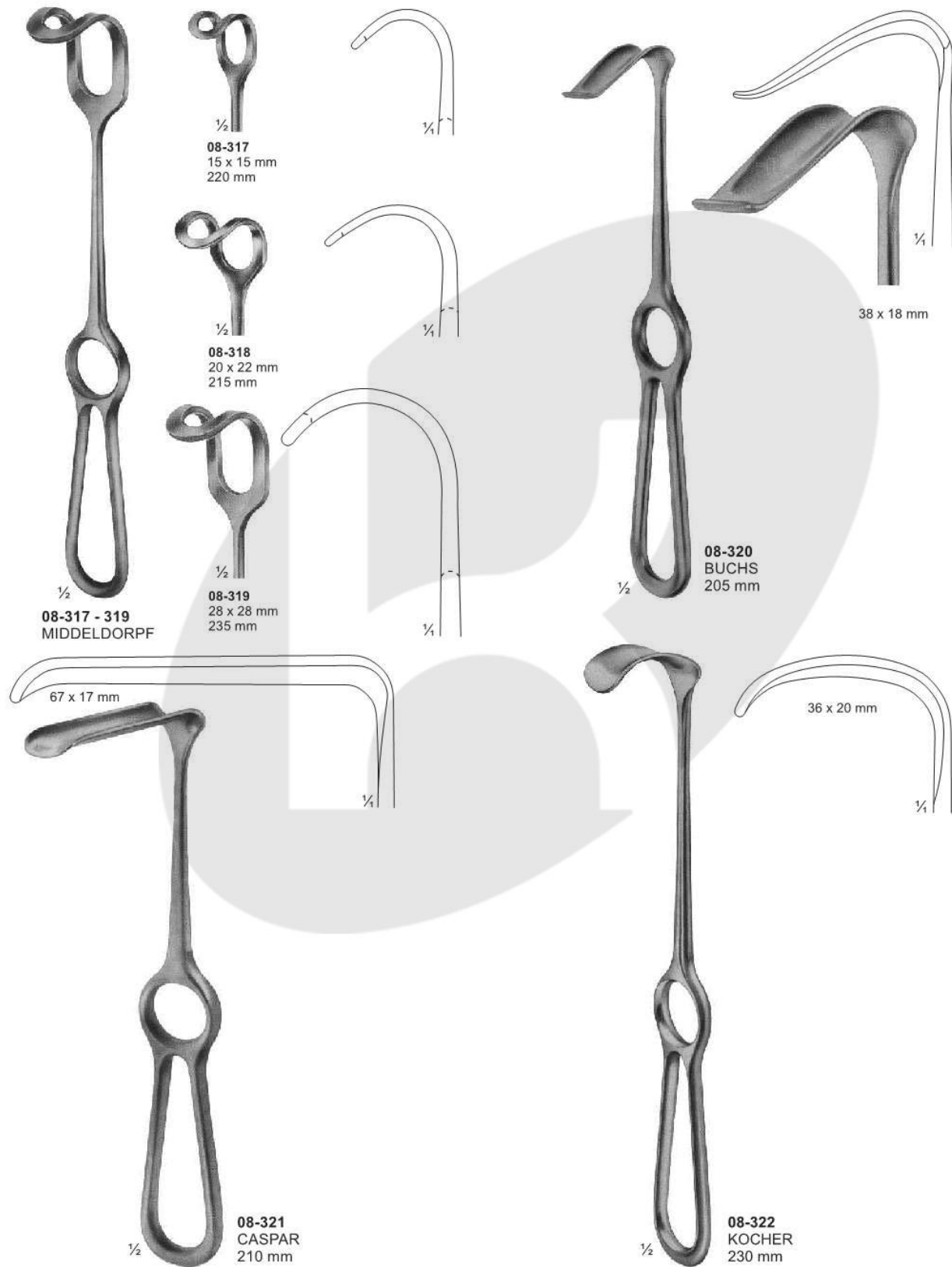

Retractors



08-323 - 328
HOSEL
250 mm

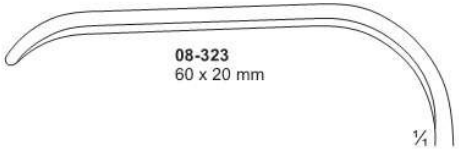

08-323
60 x 20 mm

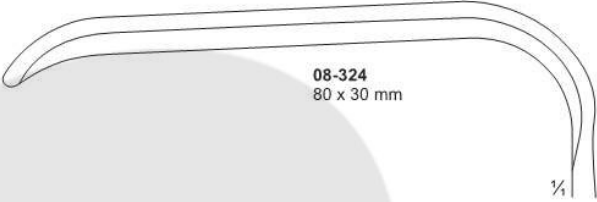

08-324
80 x 30 mm

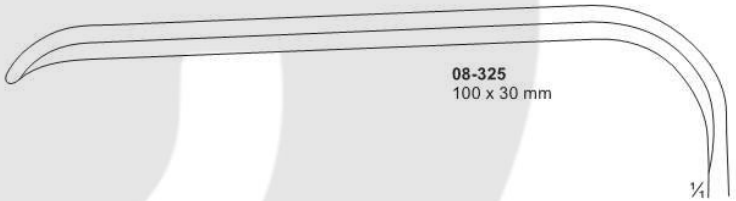

08-325
100 x 30 mm

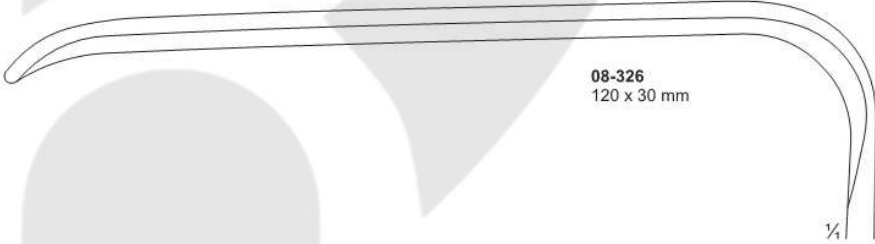

08-326
120 x 30 mm

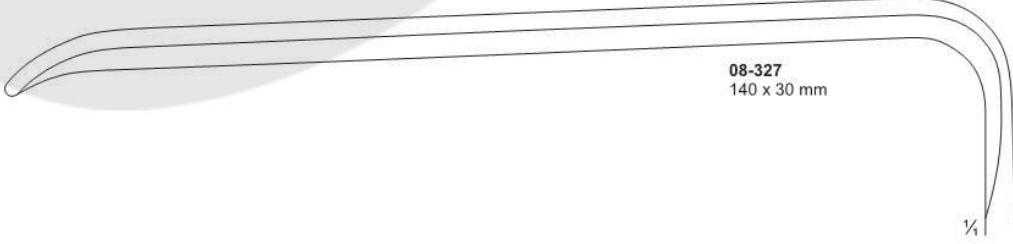

08-327
140 x 30 mm

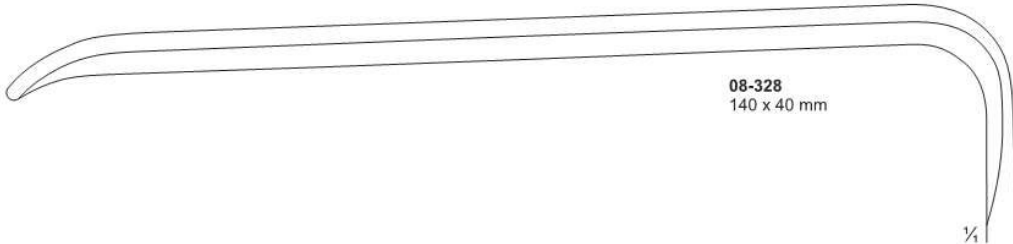

08-328
140 x 40 mm

Retractors



Retractors

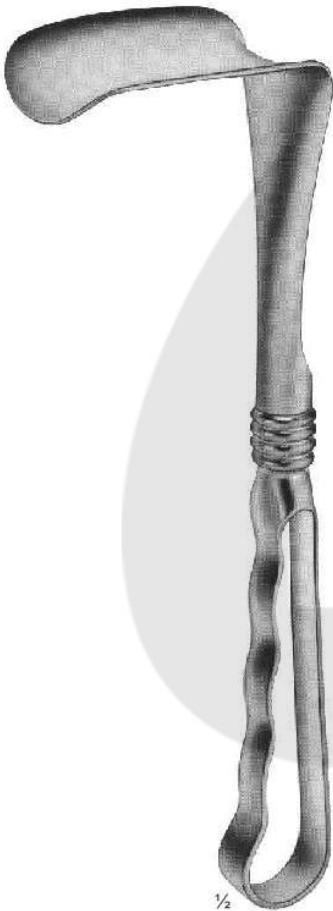
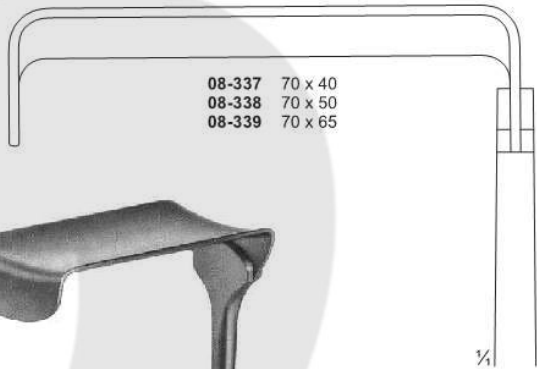
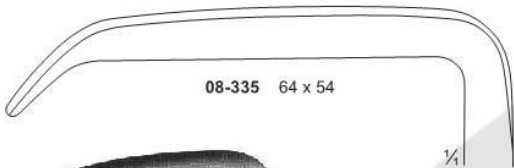
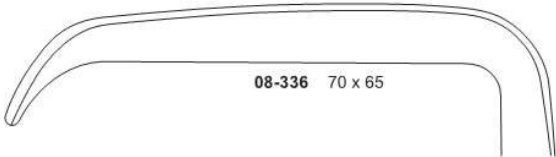

08-335 - 336
KELLY
260 mm



08-337 - 339
MORRIS
245 mm

Retractors For Deep Surgery



Retractors For Deep Surgery



Vario Retractor System, Germ. Fed. Patent,
Germ. Fed. Regd.Des.

08-347 80 x 20 mm



08-347 - 353
BRUNNER
275 mm

- 08-347 80 x 20
- 08-348 100 x 25
- 08-349 120 x 25
- 08-350 130 x 30
- 08-351 140 x 30
- 08-352 160 x 30
- 08-353 180 x 30

1/2



08-354
Handle with cold
light carrier for
retractor blades.
280 mm

1/2



Handle arrange-
ment verriable

Retractors, Lung Spatulas

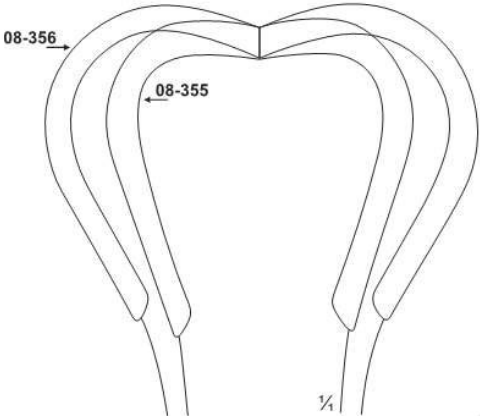

08-355 - 356
HARRINGTON
08-355 123 x 45 mm
08-356 123 x 64 mm
 Flexible
 295 mm



08-357
ALLISON
 255 mm



08-358
ALLISON
 320 mm

Retractors, Lung Spatulas



Retractors, Lung Spatulas

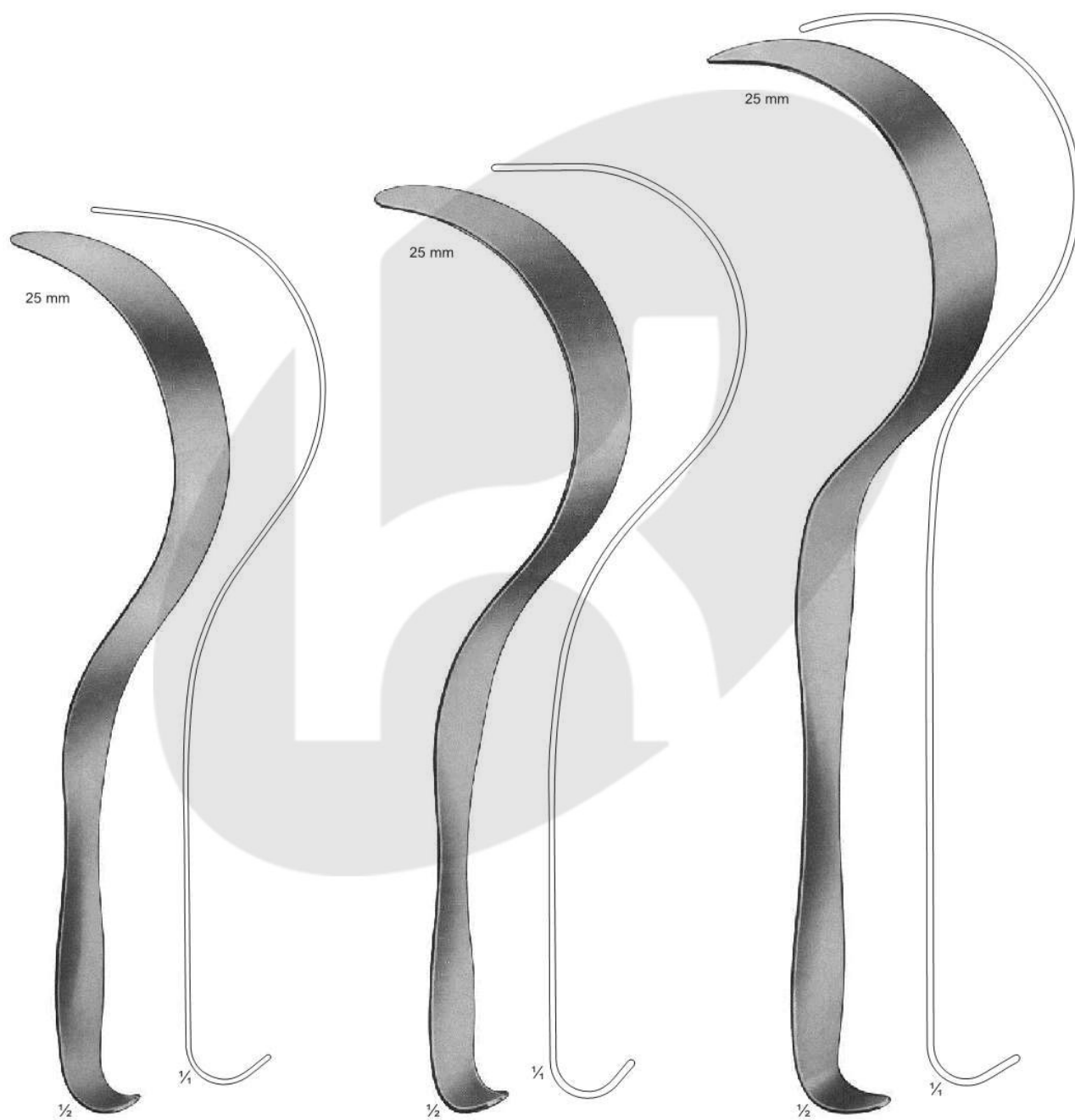

08-364
DEEVER
300 mm
Fig. 1

08-365
DEEVER
315 mm
Fig. 2

08-366
DEEVER
365 mm
Fig. 2

Retractors, Lung Spatulas



08-367
DEAVER
300 mm
Fig. 3

08-368
DEAVER
310 mm
Fig. 4

08-369
DEAVER
320 mm
Fig. 5

Retractors, Lung Spatulas



08-370
DEAVER
310 mm
Fig. 1

08-371
DEAVER
310 mm
Fig. 3

Retractors, Lung Spatulas



08-372
DEAVER
305 mm
Fig. 3

08-373
DEAVER
310 mm
Fig. 4

Retractors For Deep Surgery (Abdominal Retractors)

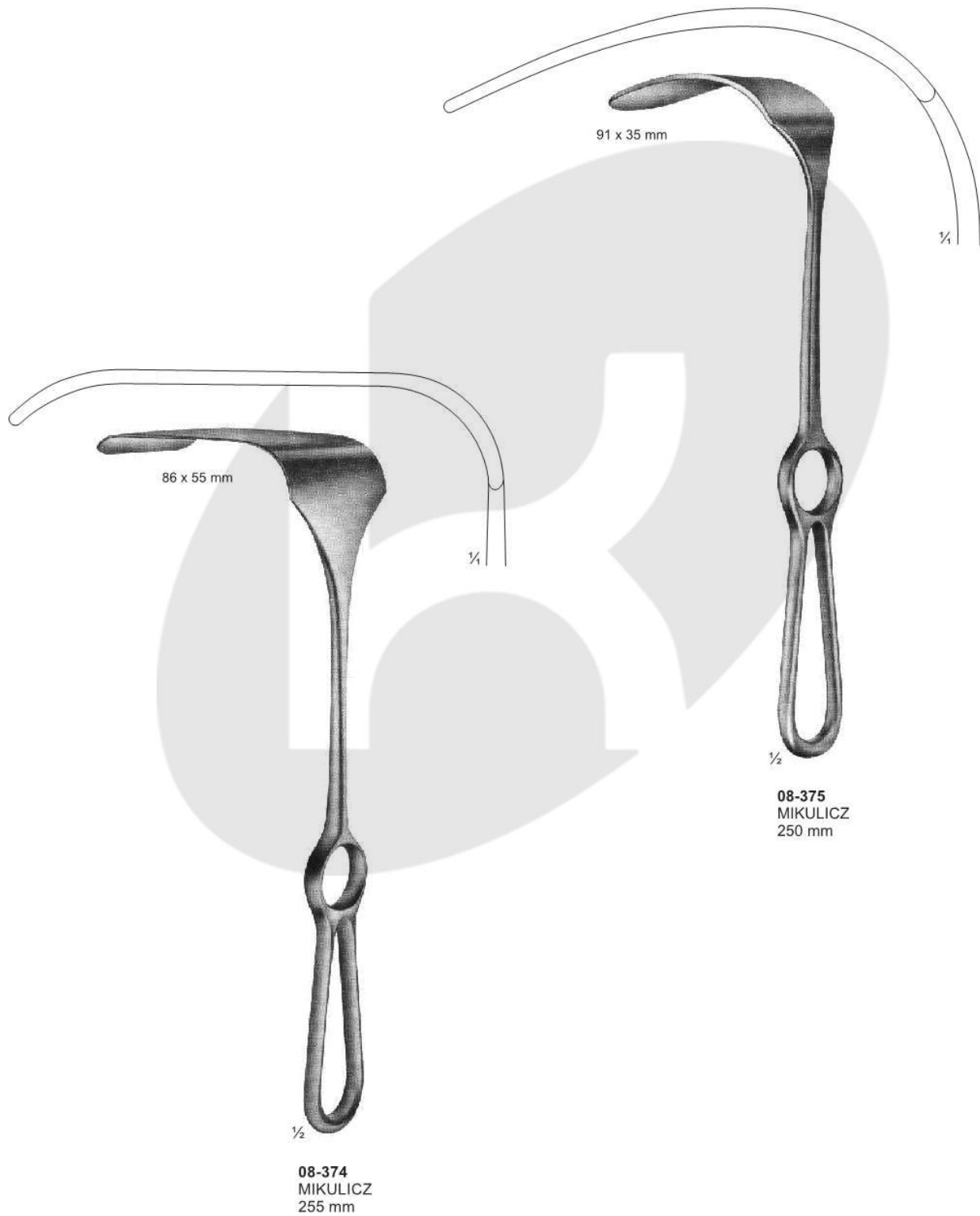

Retractors For Deep Surgery (Abdominal Retractors)

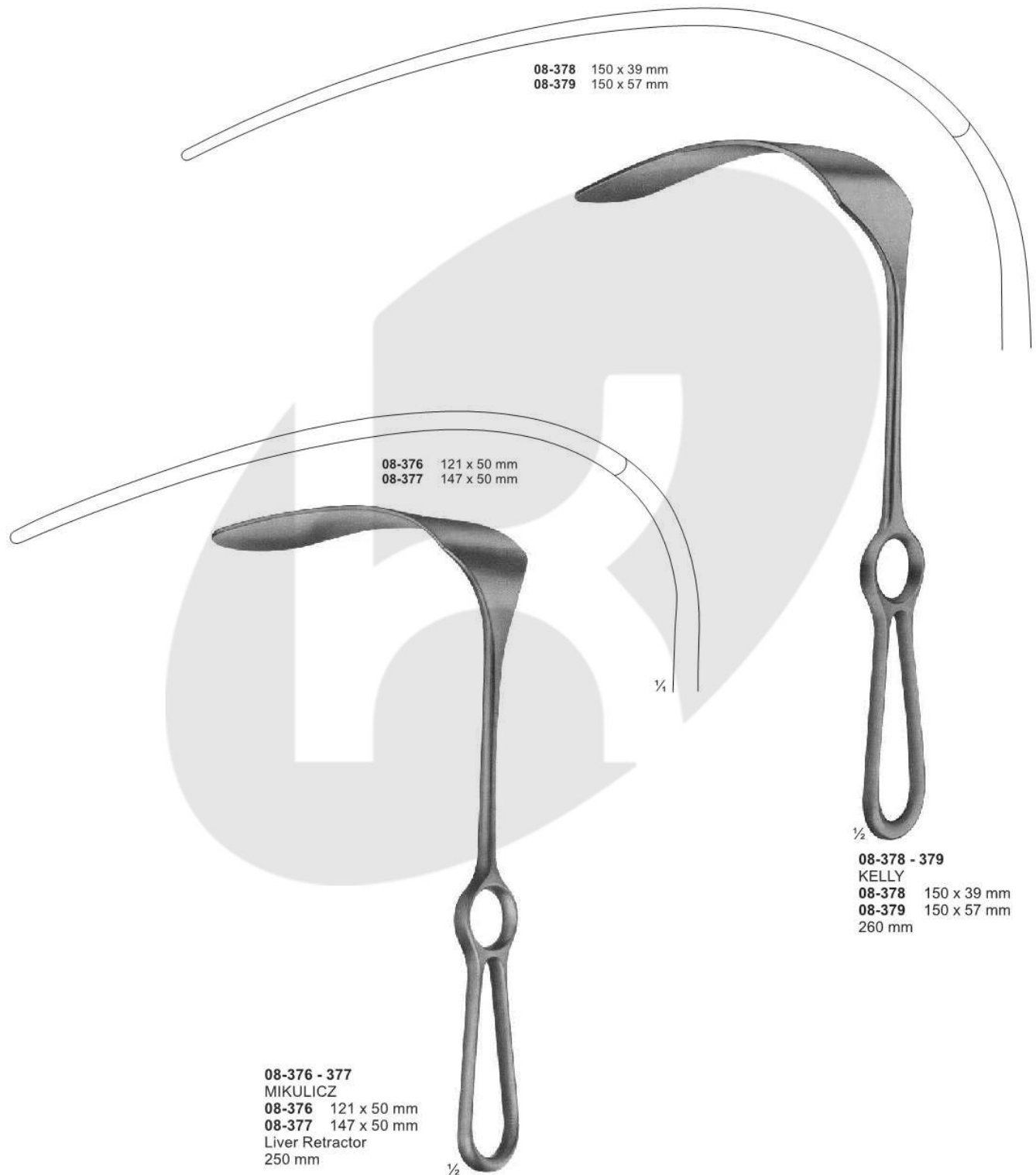

Retractors, Abdominal Retractors

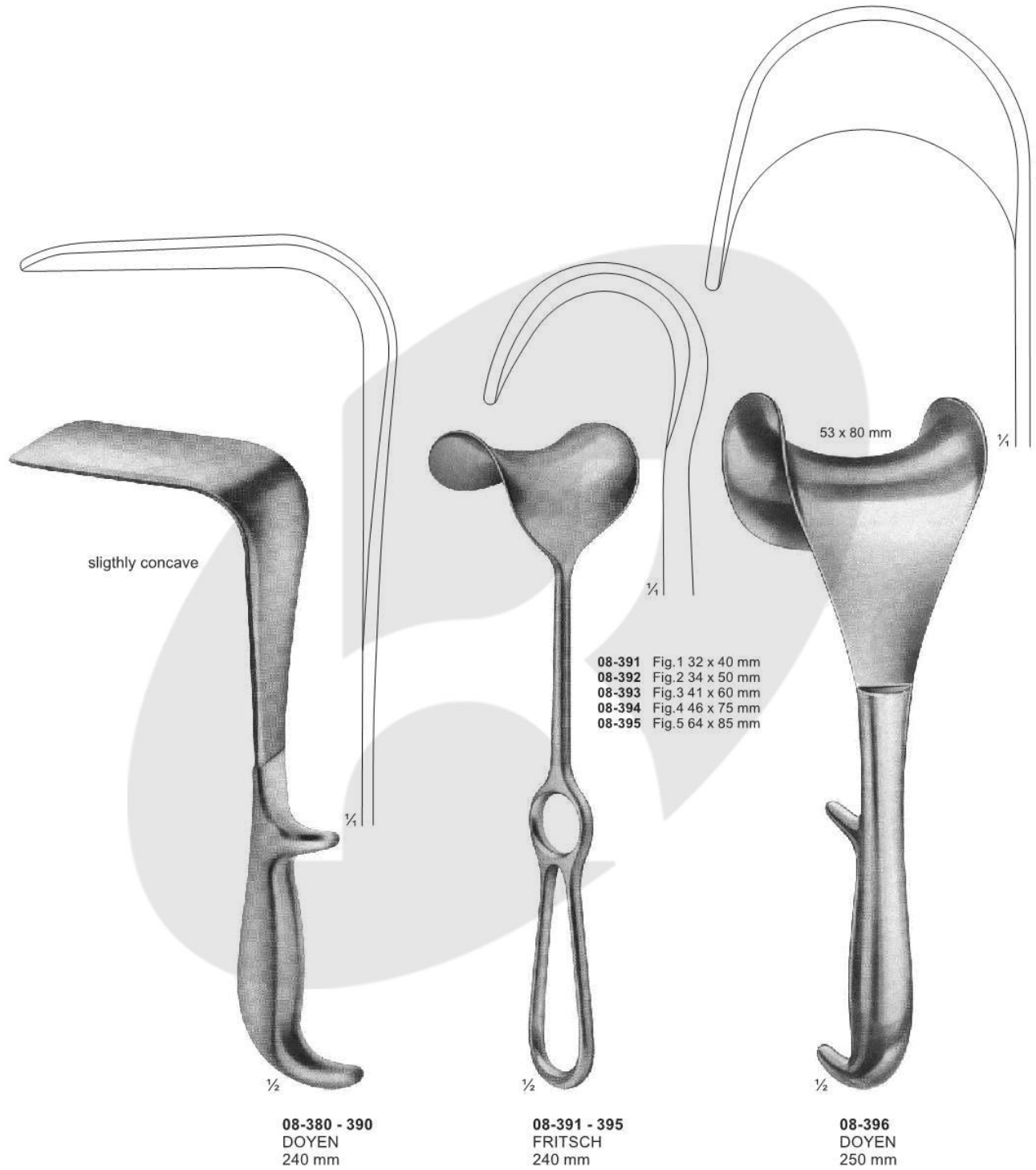

Width of Blades	
35 mm, 45 mm, 60 mm	
Length of Blades	
62 mm	08-380, 08-381, 08-382
92 mm	08-383, 08-384, 08-385
122 mm	08-386, 08-387, 08-388
160 mm	08-389, 08-390

Abdominal Retractors



08-397 - 401
ROCHARD
 310 mm
 08-397 48 x 90 mm
 08-398 48 x 105 mm
 08-399 48 x 120 mm
 08-400 48 x 135 mm
 08-401 48 x 155 mm



08-402



08-403 - 406
DOYEN
 280 mm
 08-403 48 x 90 mm
 08-404 48 x 105 mm
 08-405 48 x 120 mm
 08-406 48 x 135 mm



08-407
DOYEN-CHILD
 Fixation device
 220 mm



08-408
 Chain with
 weight (747 / 645g)
 790 mm

Pelvis Retractors

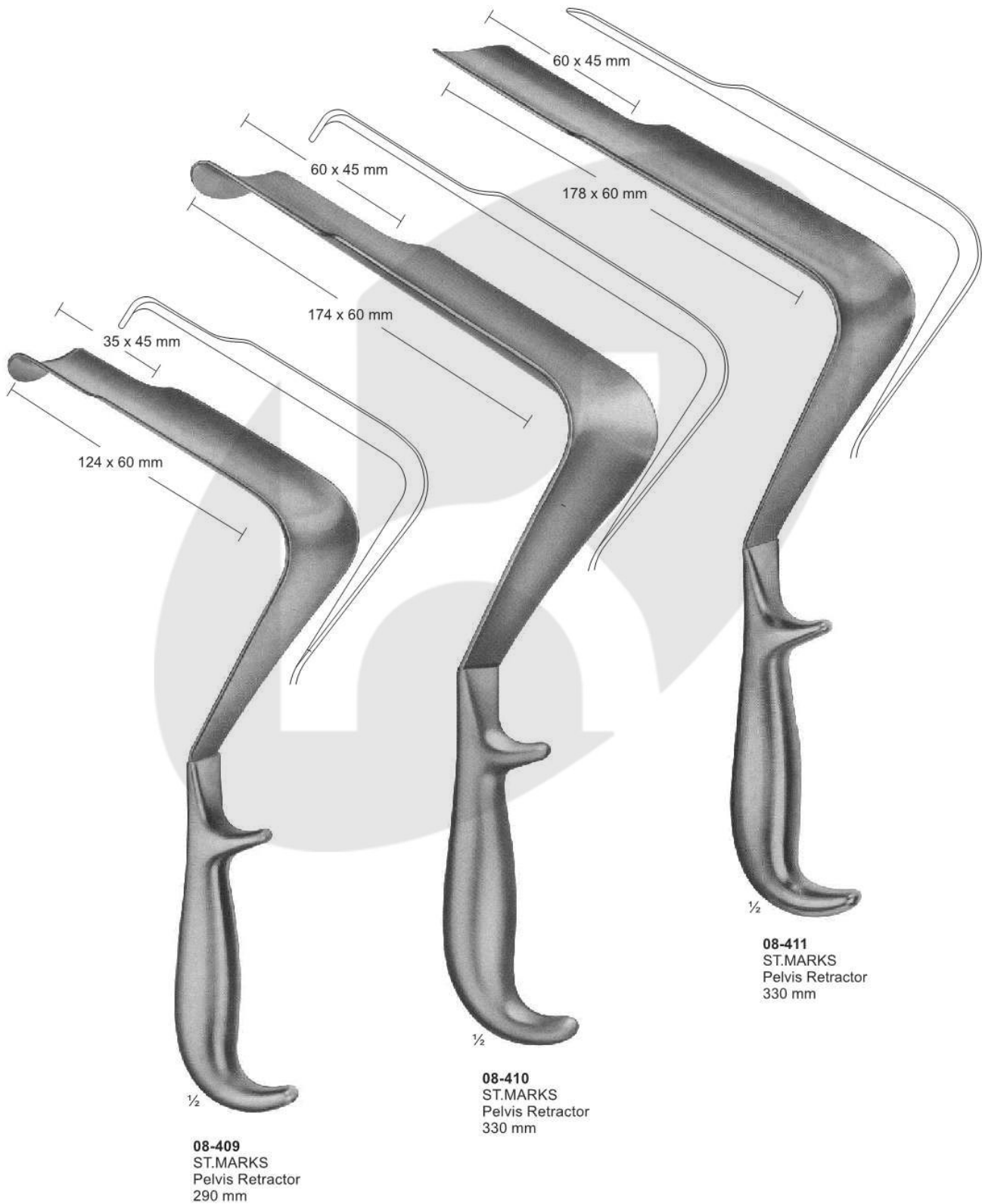

Abdominal- and Intestinal Spatulas

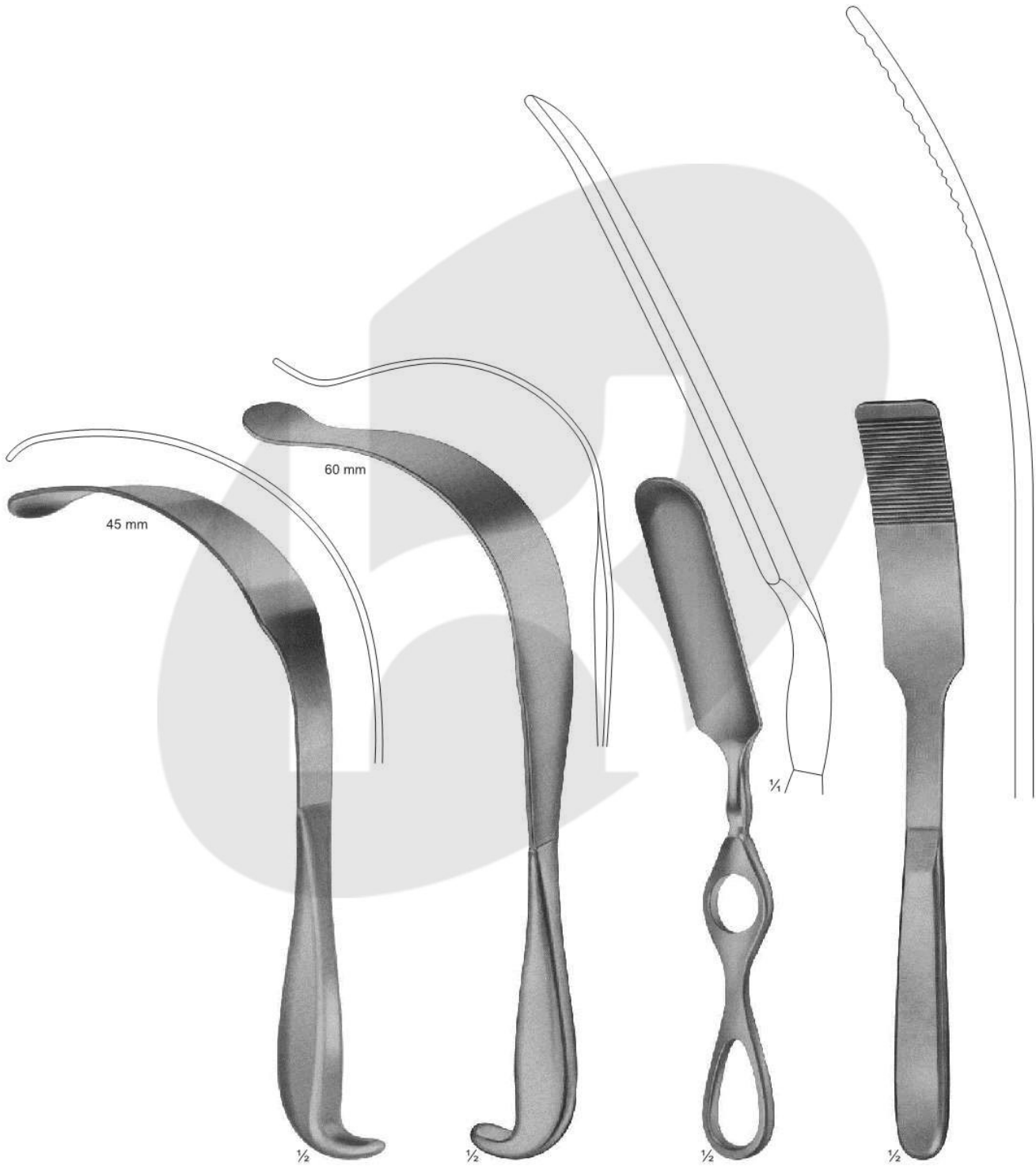

08-412
LERICHE
255 mm

08-413
KUMMEL
Melleable
285 mm

08-414
MIKULICZ
29 mm
250 mm

08-415 - 416
KADER
08-415 30 mm
08-416 40 mm
270 mm

Abdominal- and Intestinal Spatulas



08-417
REVERDIN
285 mm



08-418
HABERER
Malleable
305 mm



08-419 30 mm
08-420 40 mm
08-421 50 mm
Malleable
330 mm



08-422
TUFFIER
Malleable
200 mm

Self-Retaining Retractors



08-423
BOSE
60 mm



08-424
FINSEN
50 mm



08-425
FINSEN
70 mm



08-426
FINSEN modif.
75 mm



08-427
45 mm



08-428
55 mm



08-429
MUELLER
65 mm



08-430
100 mm



08-431 **08-432**



08-431 - 432
ALM
08-431 70 mm
08-432 100 mm

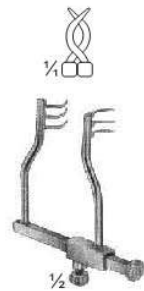

08-433
LOGAN
modif. REILL
50 mm

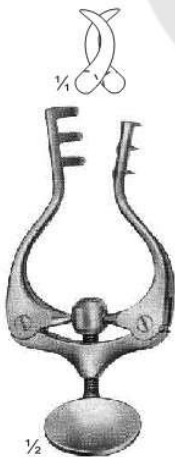

08-434
JANSEN
100 mm

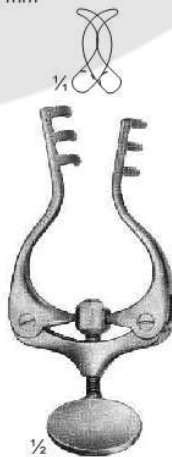

08-435
JANSEN
100 mm

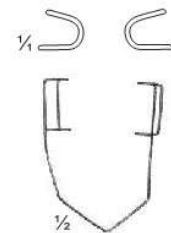

08-436
BARRAQUER
45 mm

Self-Retaining Retractors

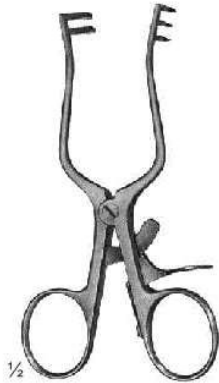

08-437
WEITLANER
Sharp
110 mm

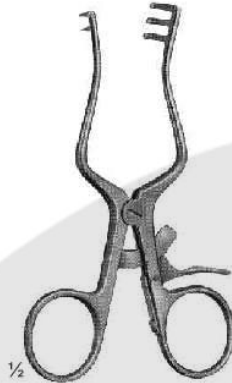

08-438
WEITLANER
Semi-Sharp
110 mm

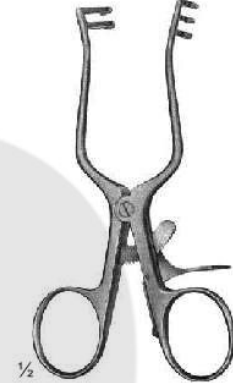

08-439
WEITLANER
Blunt
110 mm

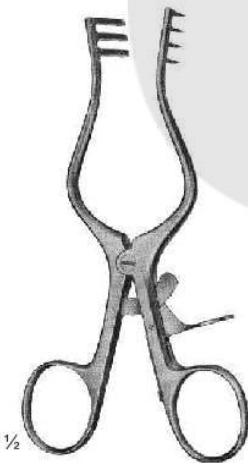

08-440
WEITLANER
Sharp
130 mm

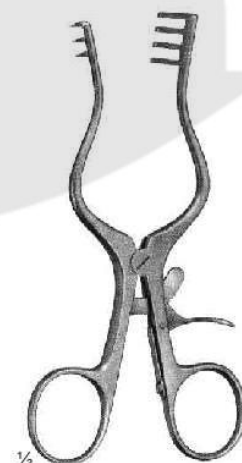

08-441
WEITLANER
Semi-Sharp
130 mm

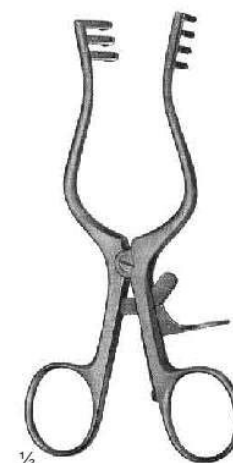

08-442
WEITLANER
Blunt
130 mm

Self-Retaining Retractors

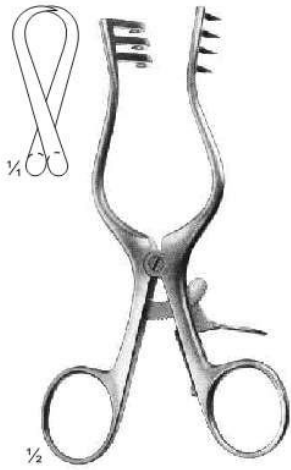

08-443
WEITLANER
Sharp
130 mm

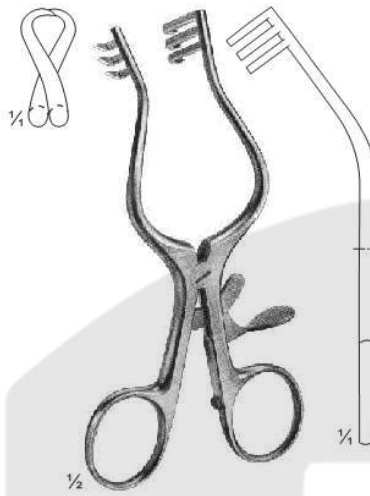

08-444
WULLSTEIN
Sharp
130 mm

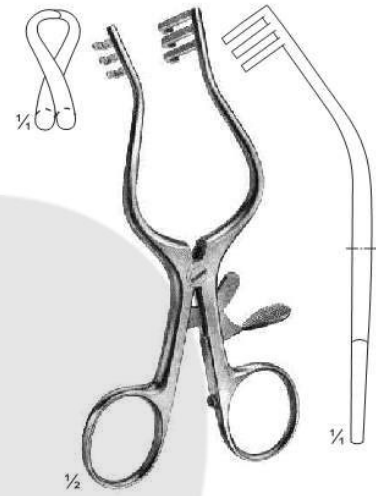

08-445
WULLSTEIN
Blunt
130 mm



08-446
WEITLANER
Sharp
165 mm

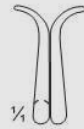

08-447
PLESTER
Blunt
110 mm



08-448
PERKINS
Blunt
130 mm

Self-Retaining Retractors

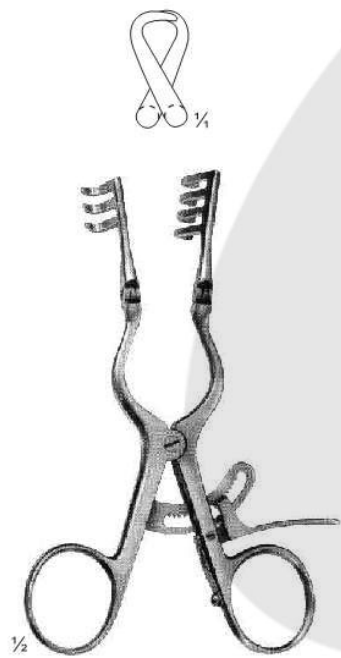

08-449
ADSON-BABY
Blunt
140 mm

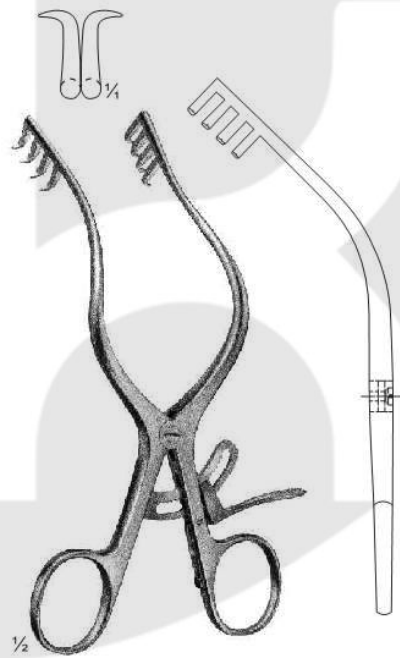

08-450
MOLLISON
Sharp
155 mm

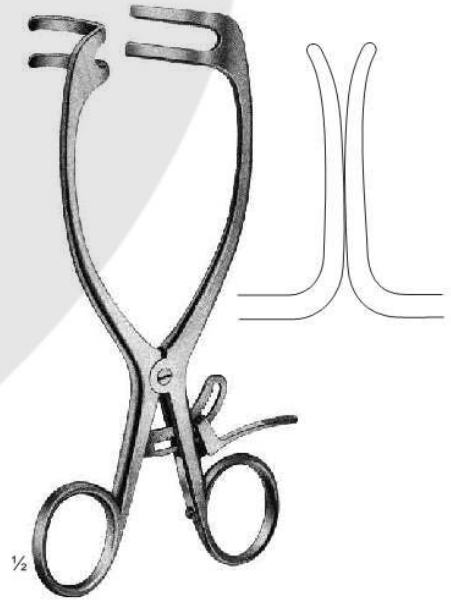

08-451
MAYO-ADAMS
165 mm

Self-Retaining Laminectomy Retractors

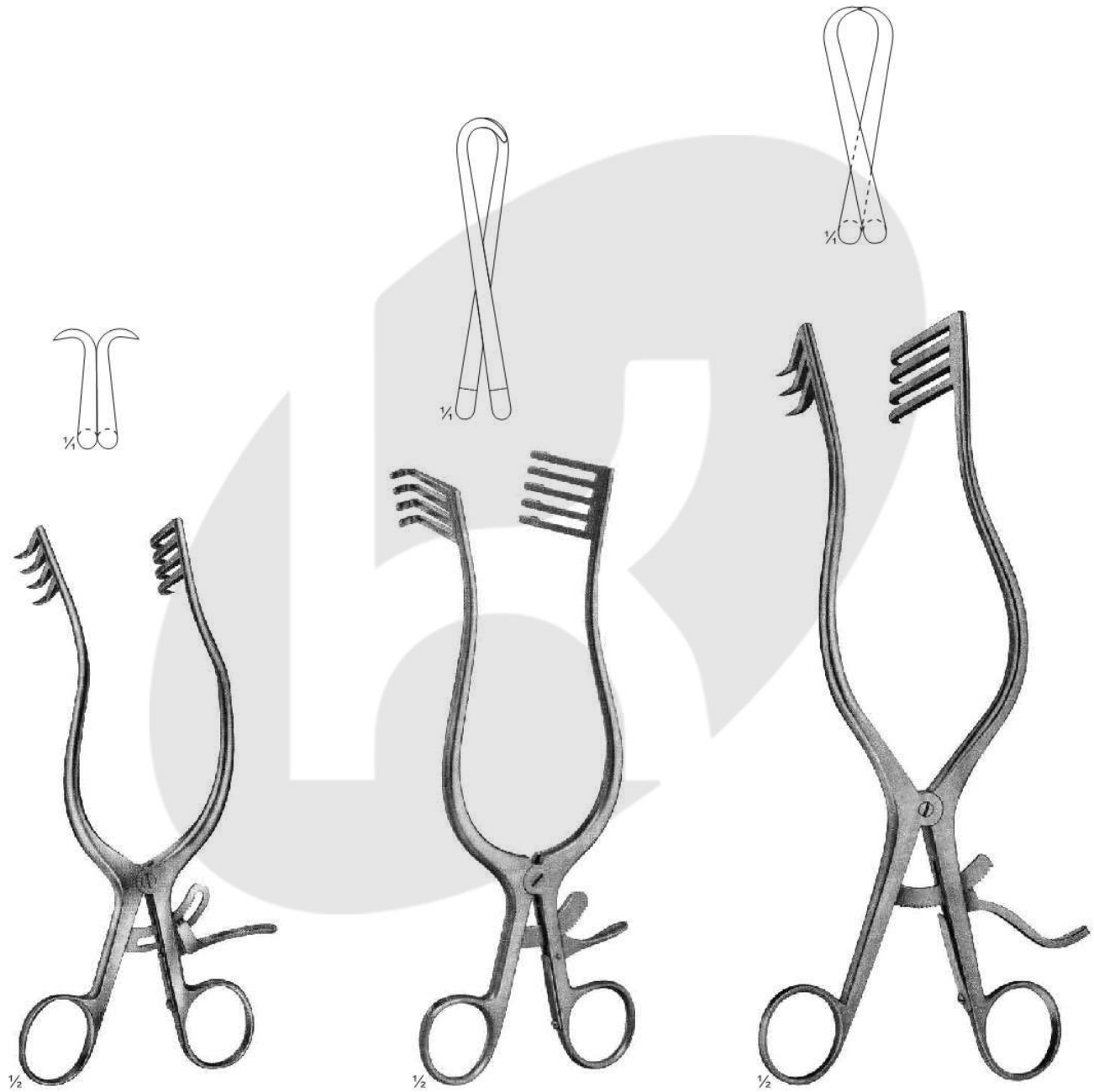

08-452
ANDERSON-ADSON
Sharp
190 mm

08-453
NORFOLK and
NORWICH
Blunt
220 mm

08-454
ADSON
Sharp
265 mm

Self-Retaining Laminectomy Retractors

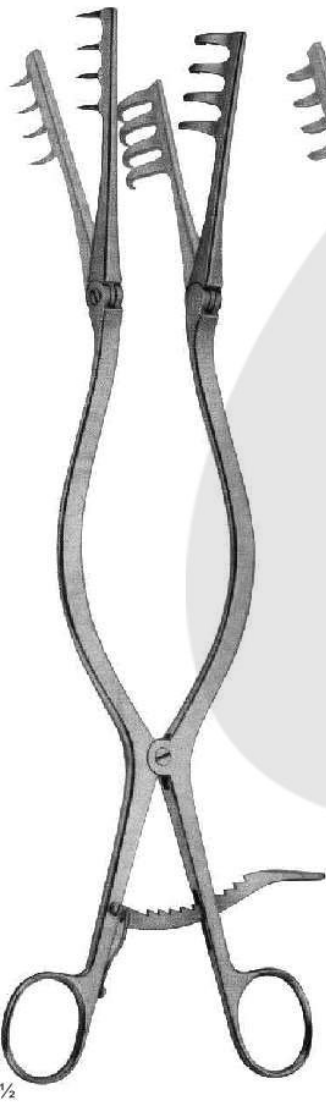
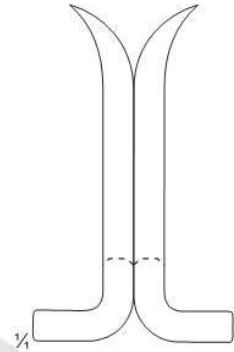
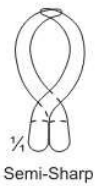
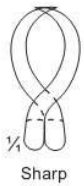

08-455 - 456
BECKMANN-ADSON
Sharp
310 mm

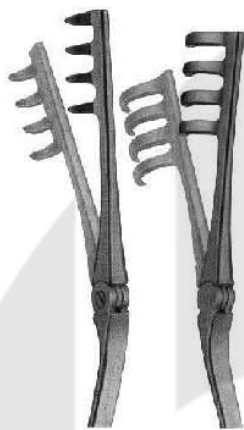

08-456
BECKMANN-ADSON
Semi-Sharp
310 mm



08-457
ADSON
Semi-Sharp
320 mm



08-458
BECKMANN-EATON
Sharp
320 mm

Special Retractors



1/2

08-459
JOLL (FRIEDMAN)
Thyroid- and Vaginal Retractor
155 mm

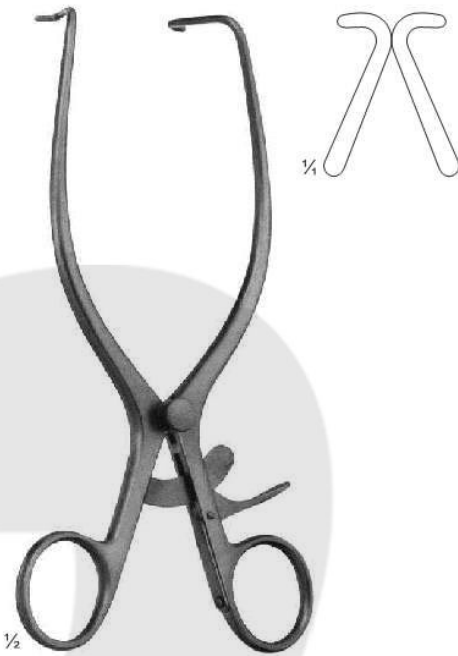

1/2

08-460
JACKSON BURROWS
Retractor, blunt
185 mm



1/4



1/4



1/2

08-461
GELPI
Vaginal Retractor
135 mm

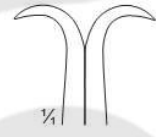

1/4



1/2

08-462
GELPI
Skin- and Vaginal Retractor
175 mm

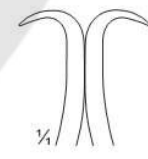

1/4



1/2

08-463
DE BAKEY
Femur Retractor
145 mm

Self Retaining Retractors for Laminectomy and other Operations

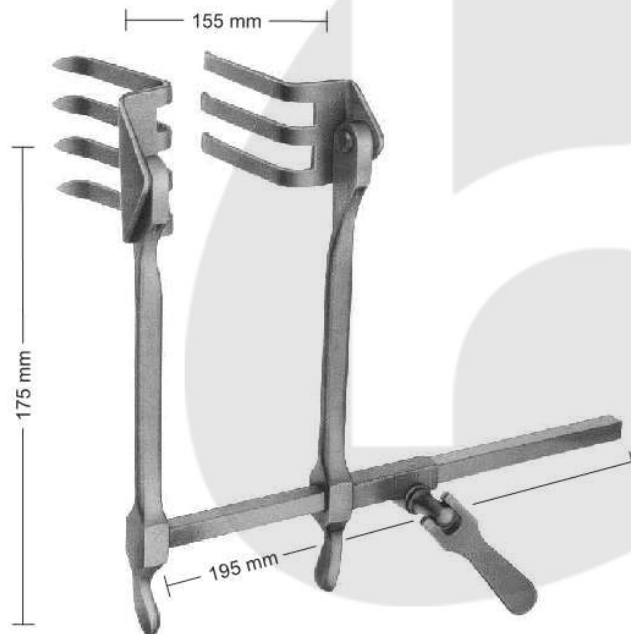

08-464 - 468
SCOVILLE-RICHTER
 Retractor with 1 pair blades reversible type. The Retractor bar and shanks may be easily rotated 180° when blades are in situ.



08-465
 62 x 52 mm 62 x 37 mm
 PR= Pair



08-466
 47 x 51 mm



08-467
 30 x 40 mm



08-468
 37 x 62 mm

Retractors for Cervical Spine

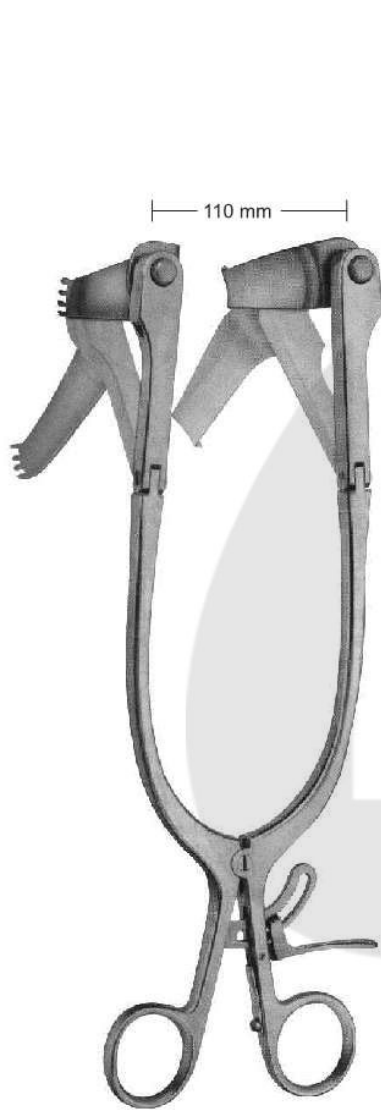

08-469
CLOWARD modif.
Spreader Only

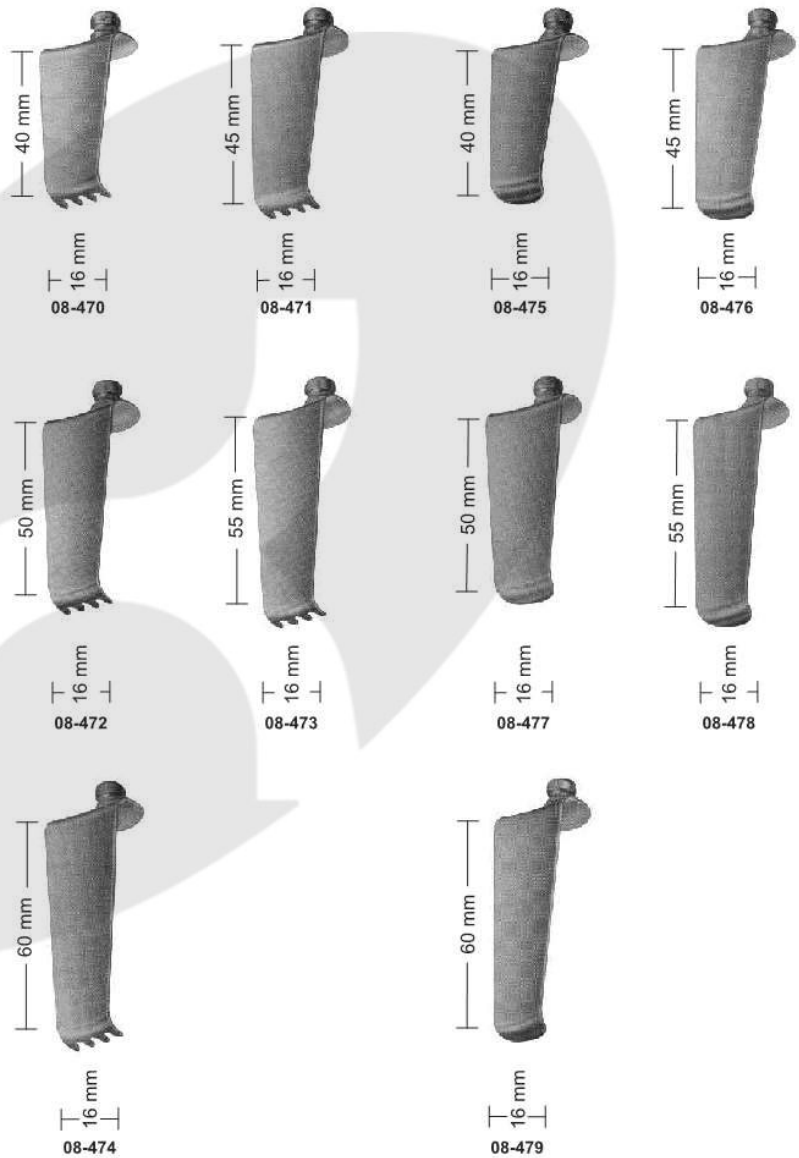

08-470 blade
08-471 blade
08-472 blade
08-473 blade
08-474 blade

08-475 blade
08-476 blade
08-477 blade
08-478 blade
08-479 blade

Retractors for Cervical Vertebral Column

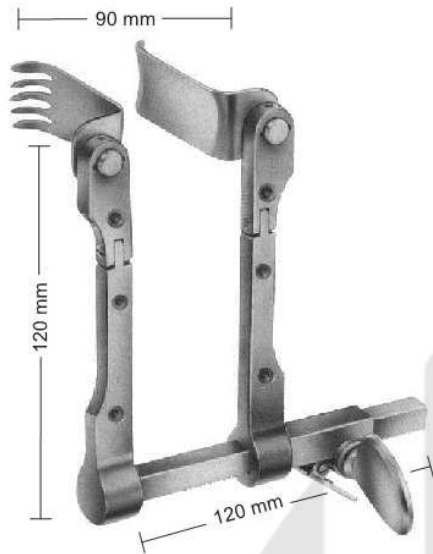

08-480
CASPAR
Retractor, adjustable,
consisting of: 5 medial
blades, 5 Lateral blades.

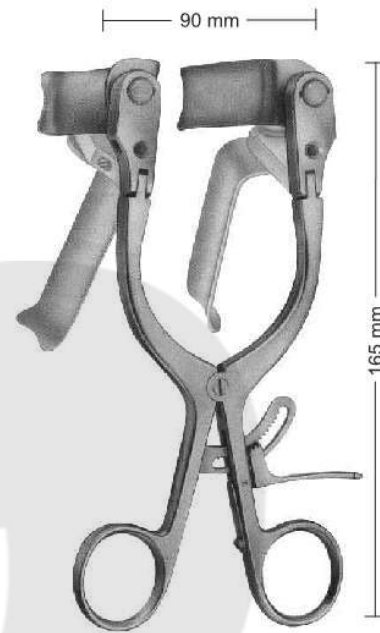

08-480 A
CASPAR
Counter retractor, adjustable,
consisting of: 5 blades.



08-481 40 x 23 mm
08-482 45 x 23 mm
08-483 50 x 23 mm
08-484 55 x 23 mm
08-485 60 x 23 mm
Medial blades



08-486 40 x 23 mm
08-487 45 x 23 mm
08-488 50 x 23 mm
08-489 55 x 23 mm
08-490 60 x 23 mm
Lateral blades



08-491 45 x 23 mm
08-492 50 x 23 mm
08-493 55 x 23 mm
08-494 60 x 23 mm
08-495 65 x 23 mm
Blunt blades



08-496 50 x 25 mm
08-497 60 x 25 mm
Blunt blades,
for harvesting of the
iliac crest



08-498 40 x 25 mm
08-499 45 x 25 mm
08-500 50 x 25 mm
08-501 55 x 25 mm
08-502 60 x 25 mm
Medial Titan blades
semi transparent to x-ray



08-503 40 x 25 mm
08-504 45 x 25 mm
08-505 50 x 25 mm
08-506 55 x 25 mm
08-507 60 x 25 mm
Lateral Titan blades
semi transparent to x-ray

Lamina Spreaders

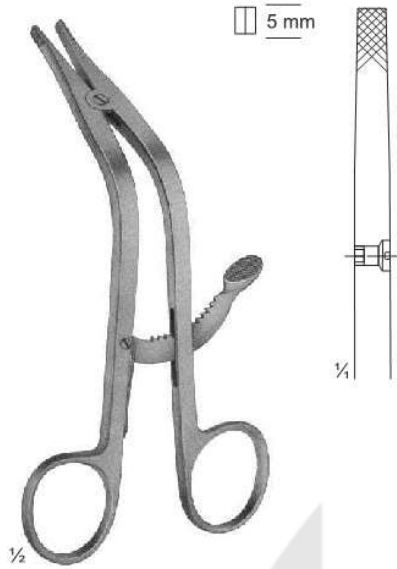

08-508
CLOWARD
155 mm

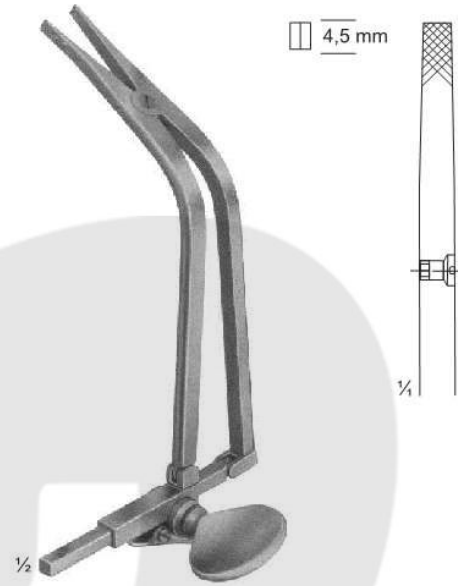

08-509
CLOWARD
135 mm

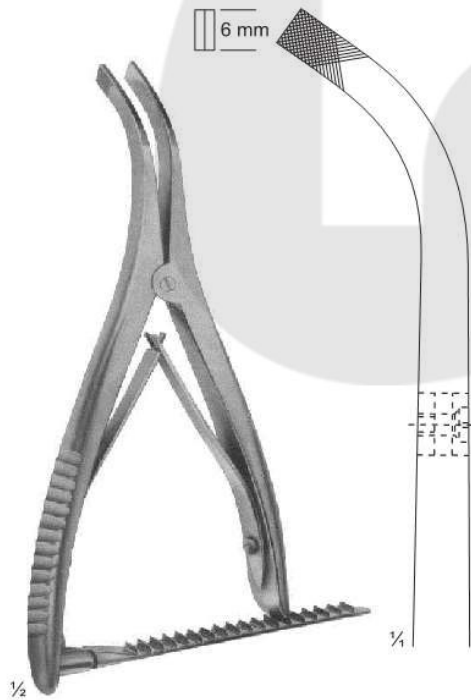

08-510
INGE
170 mm

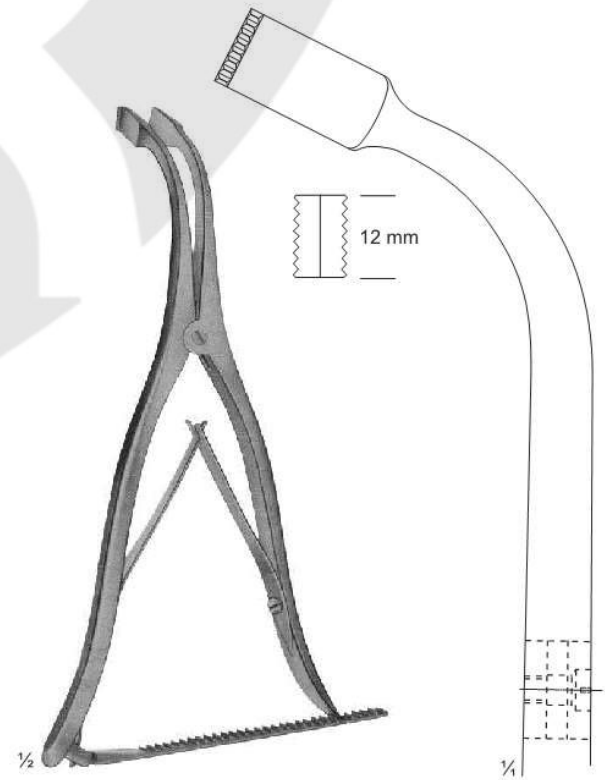

08-511
INGE
275 mm

Abdominal Retractors

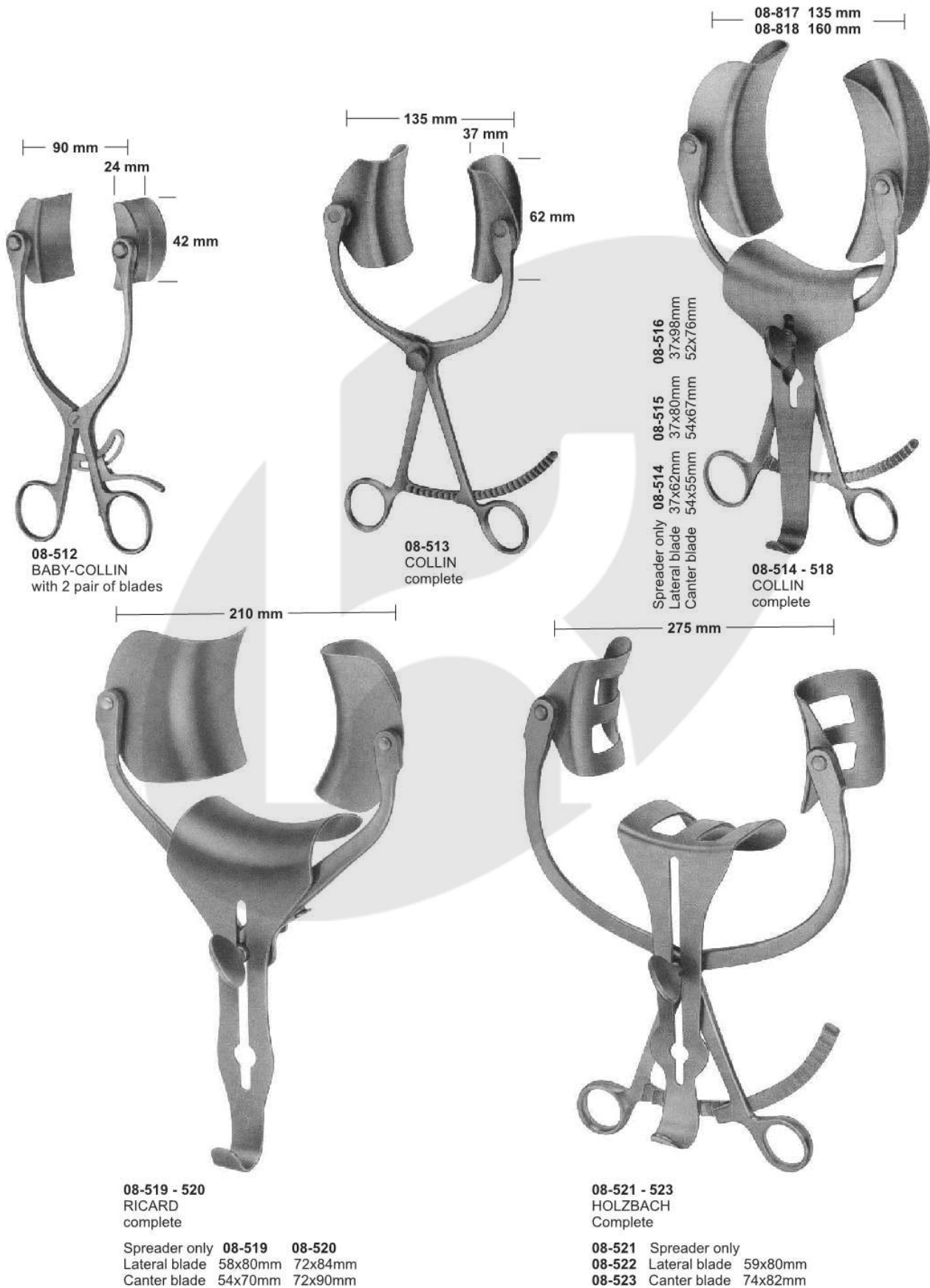

Abdominal Baldes

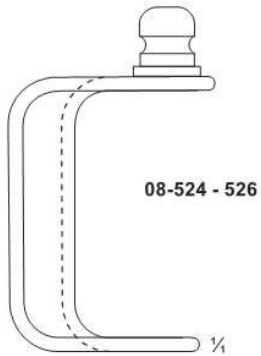

Lateral blades only
 08-524 37x62 mm
 08-525 37x80 mm
 08-526 37x98 mm

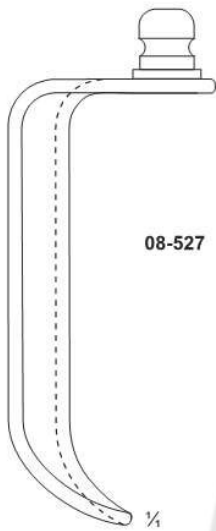

08-527 61x80 mm

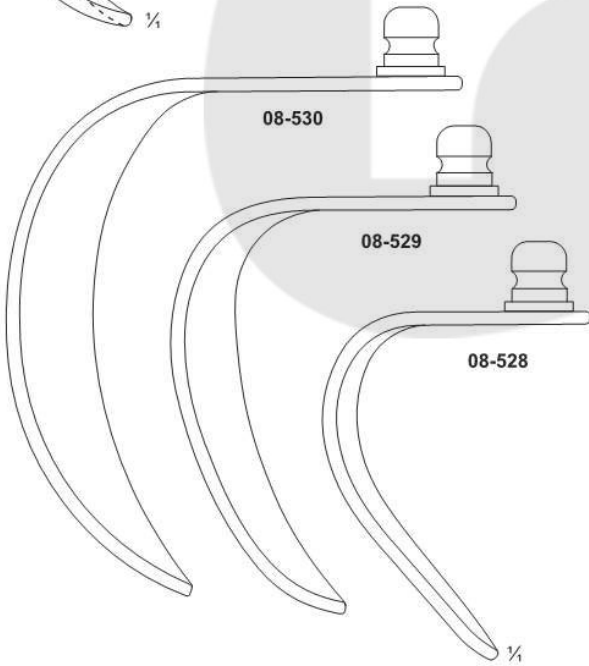

08-528 48x59 mm
 08-529 58x80 mm
 08-530 72x84 mm

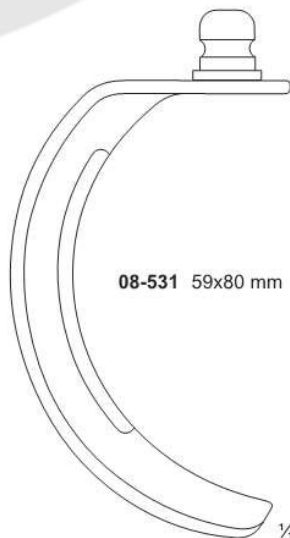

Abdominal Retractors

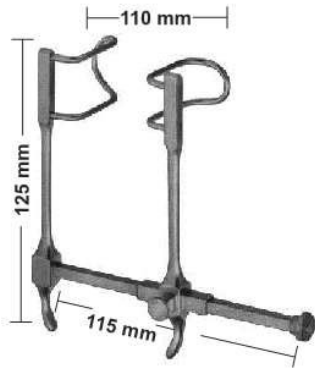

08-532
GOSSET
Blades:38 mm deep

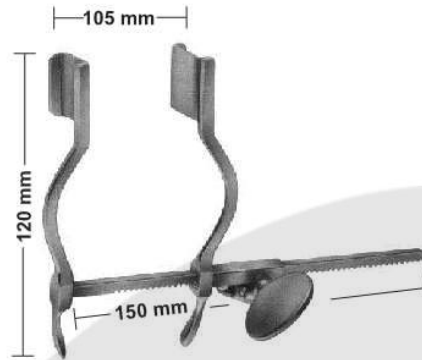

08-533
HERTZLER
Blades 20 X 25 mm

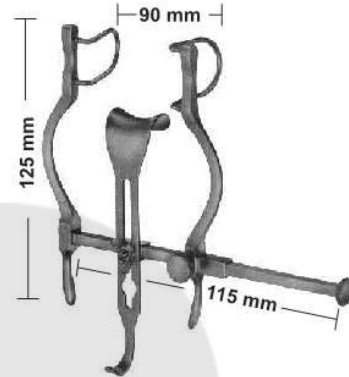

08-534
BALFOUR-BABY
Lateral blades 27 mm deep
Center blade 21x24 mm

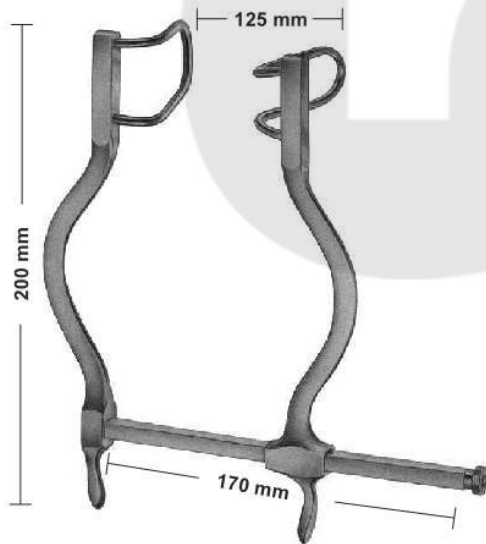

08-535
GOSSET
Blades:55mm deep

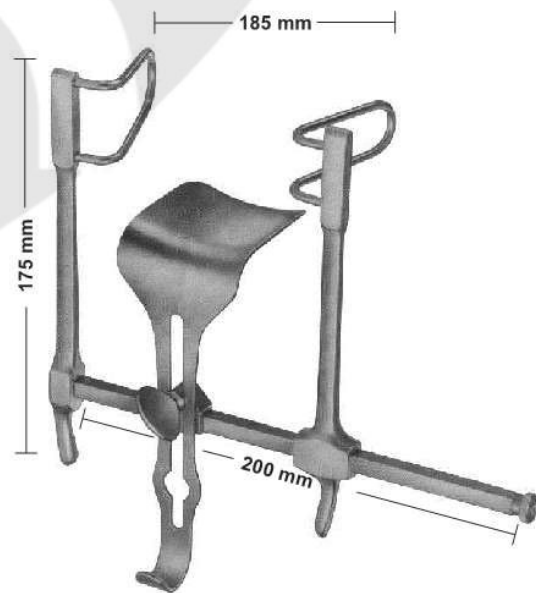

08-536
GOSSET
Lateral blades 58 mm deep
Center blade 59 x 57 mm

Abdominal Retractors

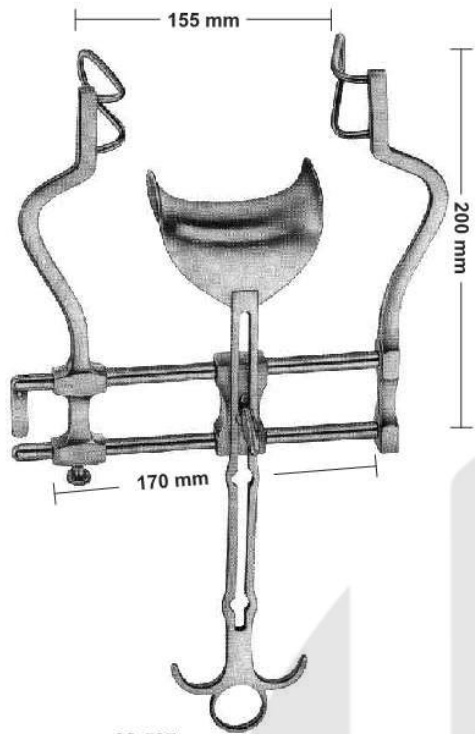

08-537
BALFOUR
Lateral blades 60 mm deep
Center blade 47 x 80 mm

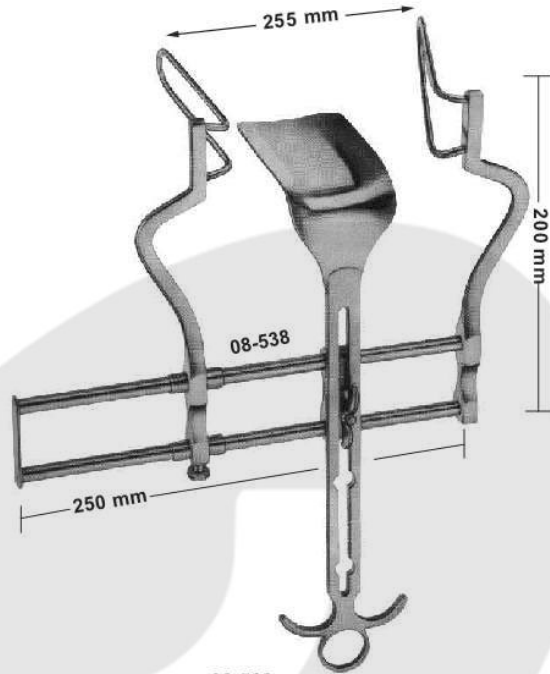

08-538
BALFOUR
Lateral blades 105 mm deep
Center blade 107x 59 mm



08-539
Center blade only
54x80 mm

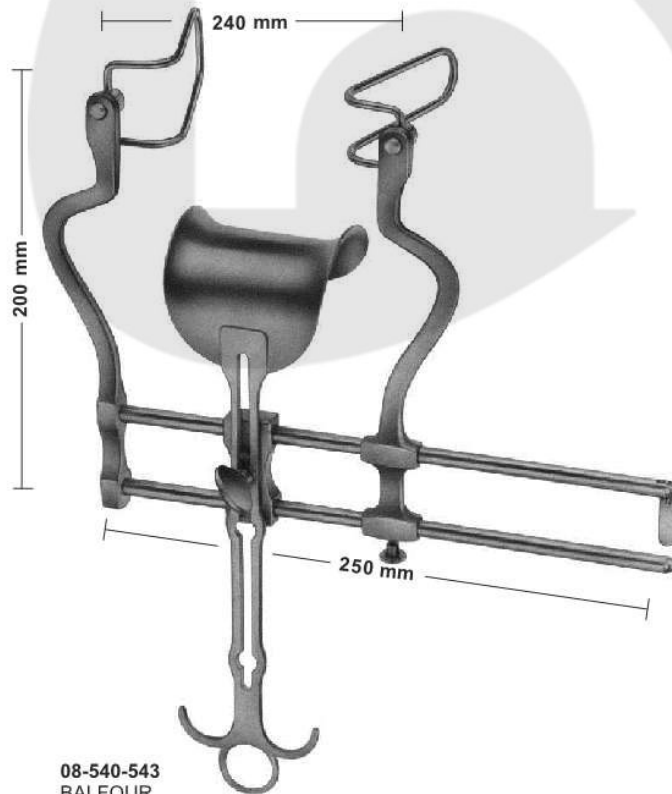

08-540-543
BALFOUR
Spreader only
Lateral blades
Center blade

	08-540	08-541	08-542	08-543
Lateral blades	50 mm	60 mm	75 mm	90 mm
Center blade	47 x 80 mm	62x76 mm	80x80 mm	80x80 mm



Sales Unit of blades:PR = pair

Lateral blades
08-544
50 mm deep
08-545
60 mm deep
08-546
75 mm deep
08-547
90 mm deep

Abdominal Retractors

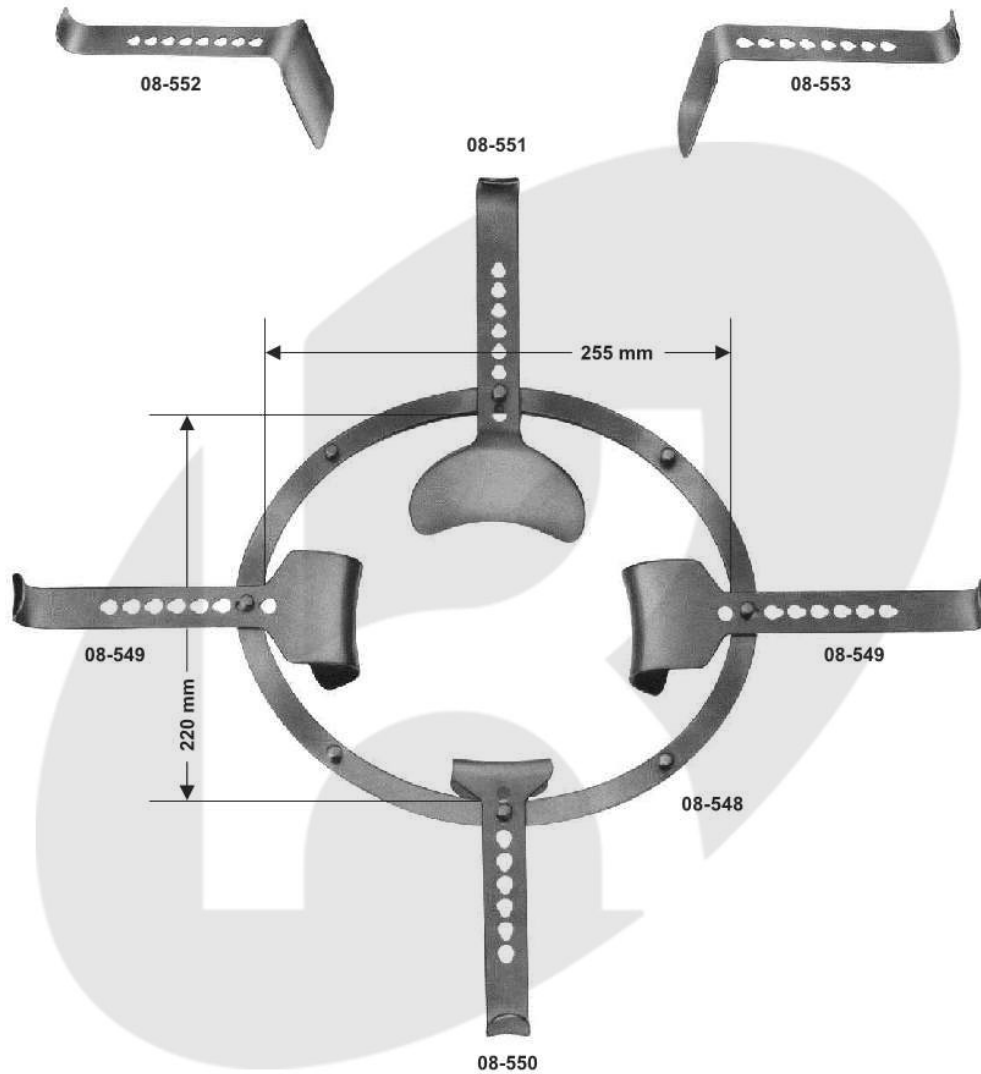

08-548 - 08-553

SEMM

consisting of:

08-548 1 frame 225 x 220 mm

08-549 2 blades 46 x 64 mm

08-550 1 blade 53 x 54 mm
(for bladder)

08-551 1 blade 82 x 97 mm
(for intestine)

08-552 1 blade 98 x 51 mm
(for intestine)

08-553 1 blade, narrow
107 x 36 mm

Abdominal Retractors

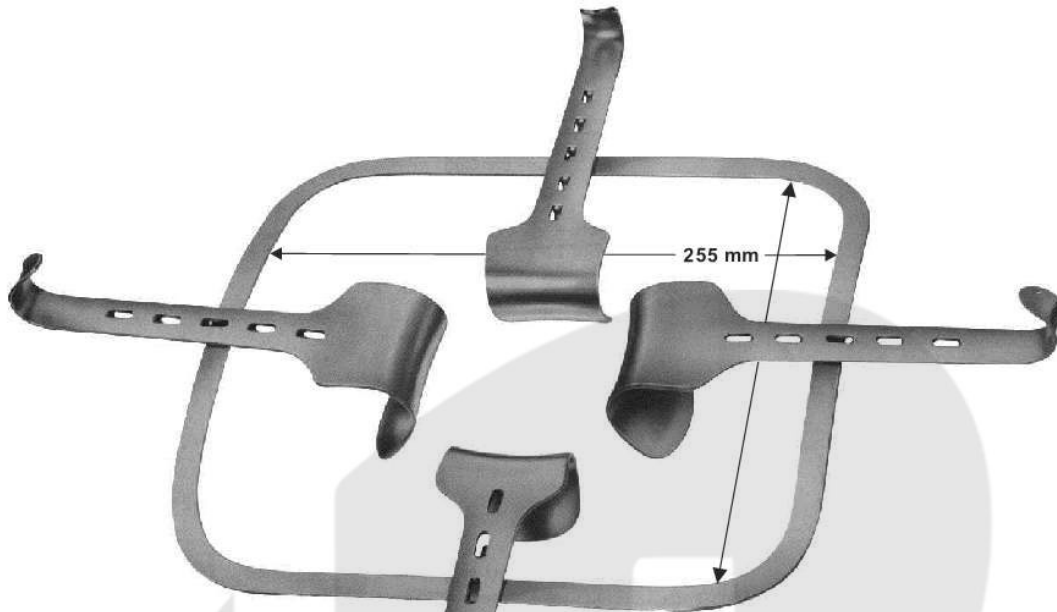

KIRSCHNER
08-554
 with vaulted fixed frame
 and 2 blade
08-555
 275 x 355 mm
 Frame only, over-sized
08-556
 295 x 275 mm
 Frame only



08-557
KIRSCHNER
 64 x 80 mm



08-558
KIRSCHNER-BALFOUR
 80x 82 mm



08-559 - 561
KIRSCHNER
08-559 90x 69mm
08-560 92x 95mm
08-561 78x 58mm



08-562 - 564
KIRSCHNER
08-562 108x42mm
08-563 91x 55mm
08-564 121x 55mm

Intestinal and Tissue Grasping Forceps



09-101
CHAPUT
 2 X 3 teeth, sharp
 125 mm,

09-102
TUFFIER
 5 X 6 teeth, sharp
 125 mm,

09-103
BOYS-ALLIS
 5 X 6 teeth, sharp
 155 mm,

09-104
ALLIS
 4 X 5 teeth
 155 mm,

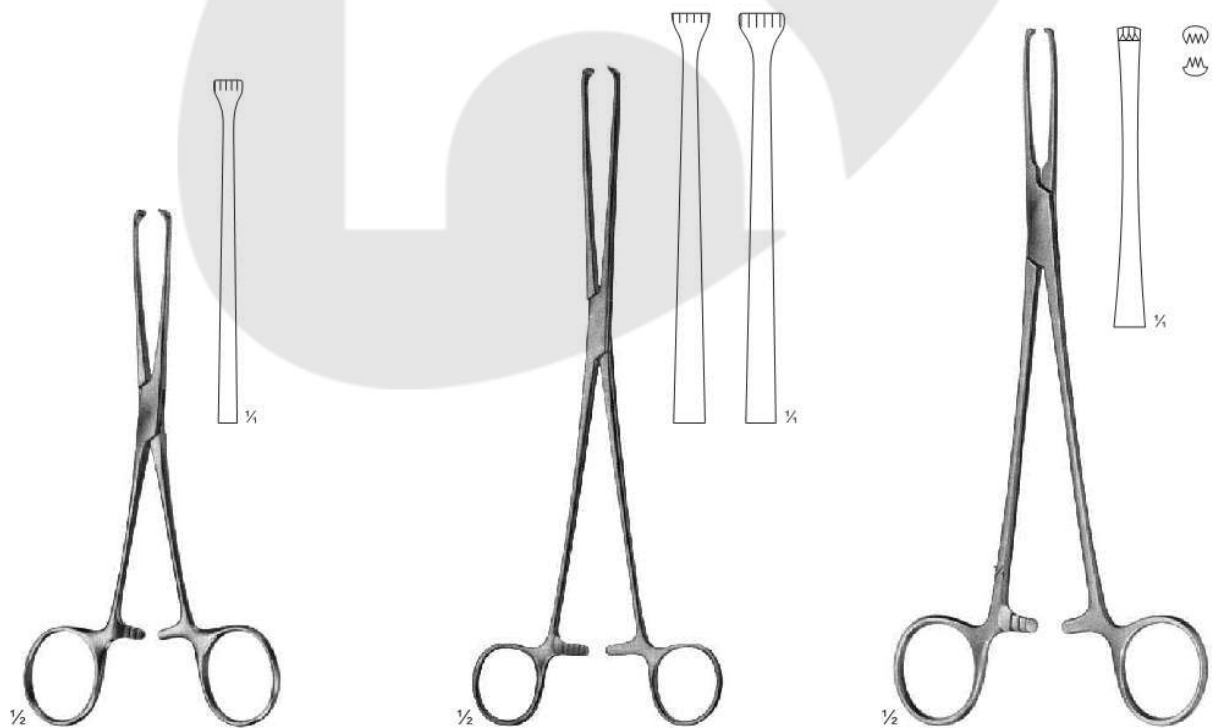

09-105
ALLIS
 155 mm,
 4 X 5 teeth

09-106
ALLIS
 190 mm,
09-107
 255 mm,
 5 X 6 teeth

09-108
JUDD-ALLIS
 3 X 4 teeth
 195 mm,

Intestinal Grasping Forceps

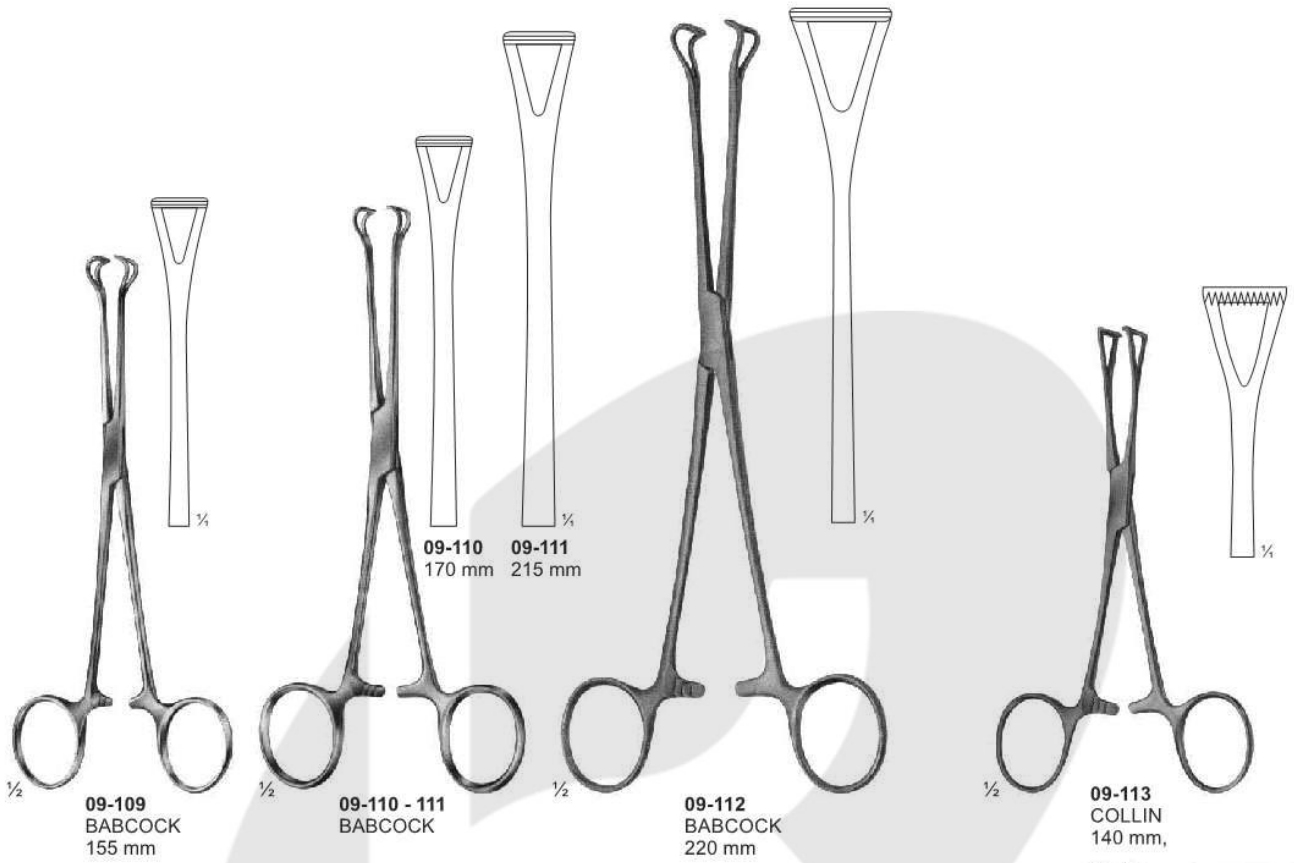

Organ - Tissue Grasping, Dissecting & Intestinal Forceps

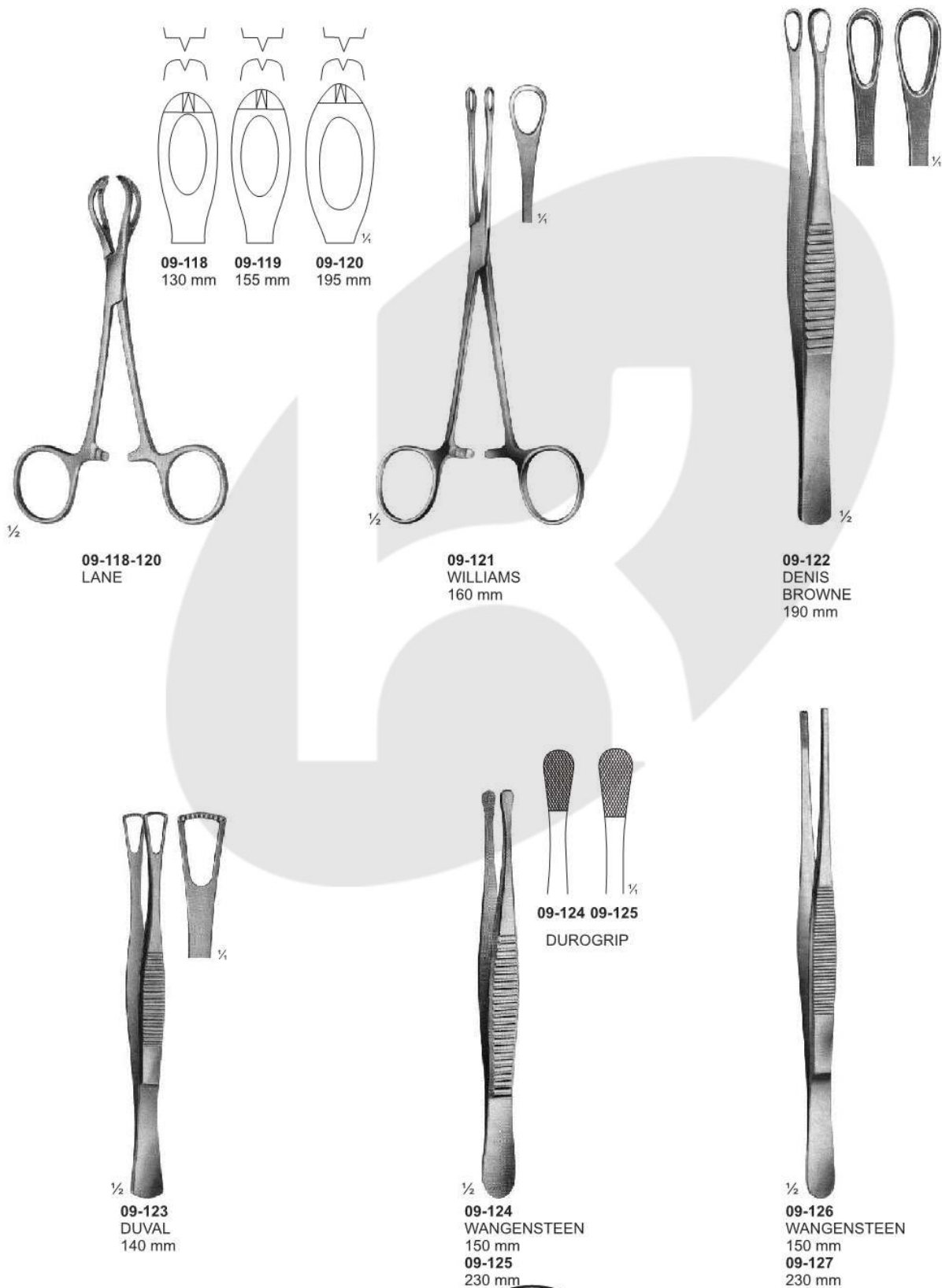

Organ - Tissue Grasping, Dissecting & Intestinal Forceps

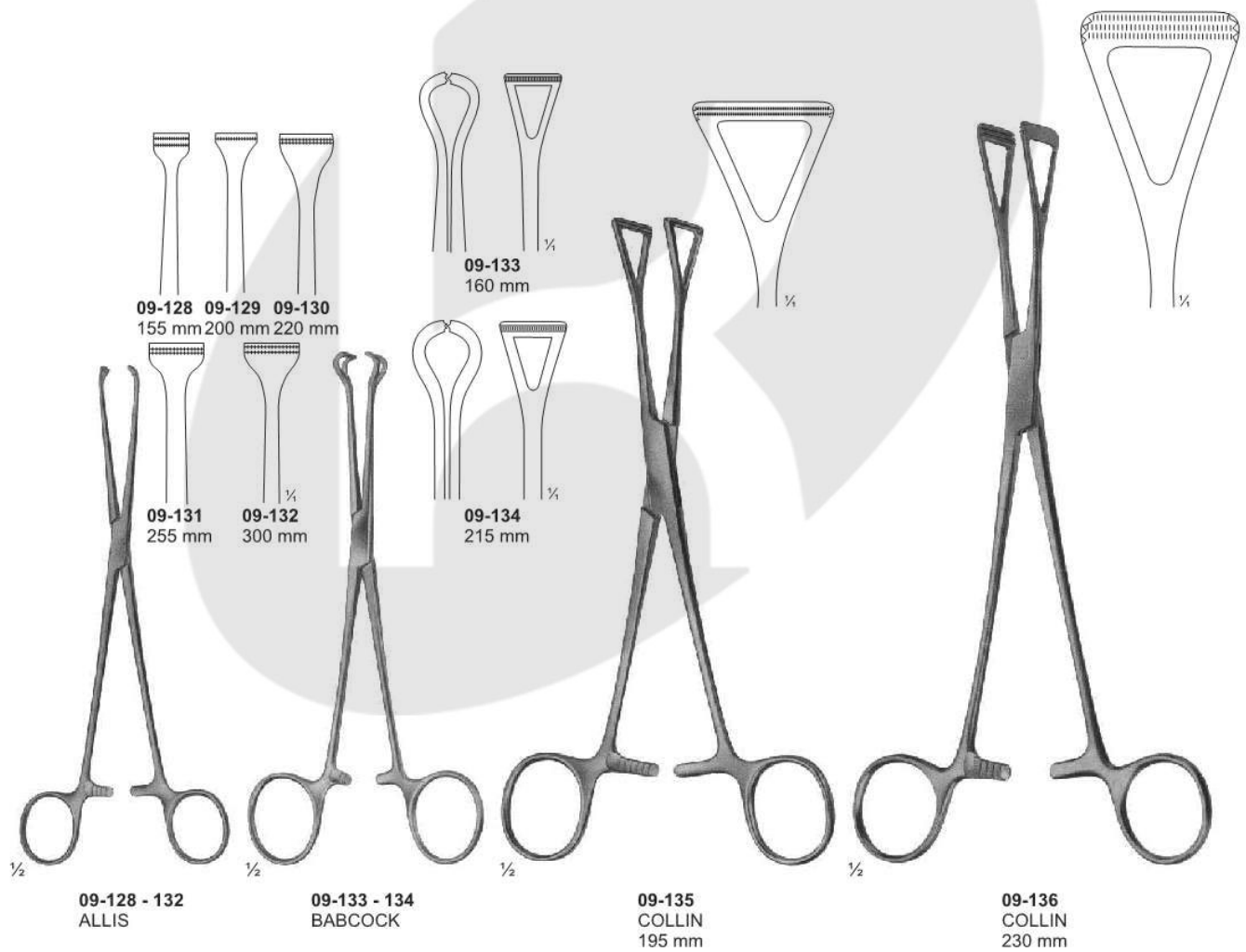

Ultra - Light - Forceps, Dissecting Forceps

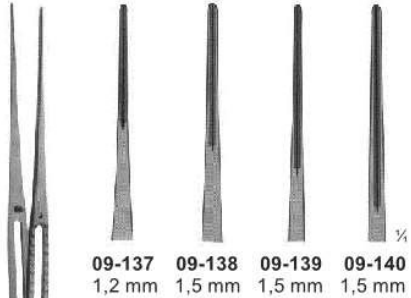

$\frac{1}{2}$
09-137 150 mm
09-138 200 mm
09-139 240 mm
09-140 300 mm

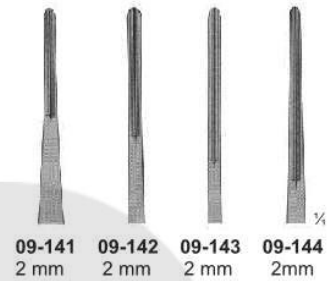

$\frac{1}{2}$
 DE BAKEY
09-141 150 mm
09-142 200 mm
09-143 240 mm
09-144 300 mm

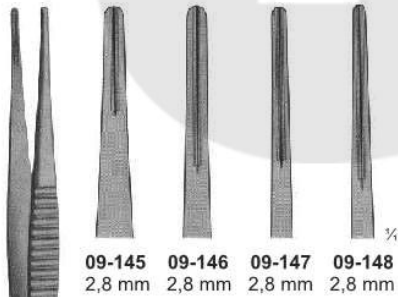

$\frac{1}{2}$
 DE BAKEY
09-145 150 mm
09-146 200 mm
09-147 240 mm
09-148 300 mm

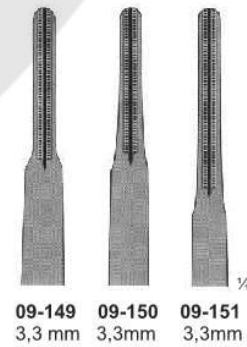

$\frac{1}{2}$
 DE BAKEY
09-149 200 mm
09-150 240 mm
09-151 300 mm

Intestinal Clamps for Children

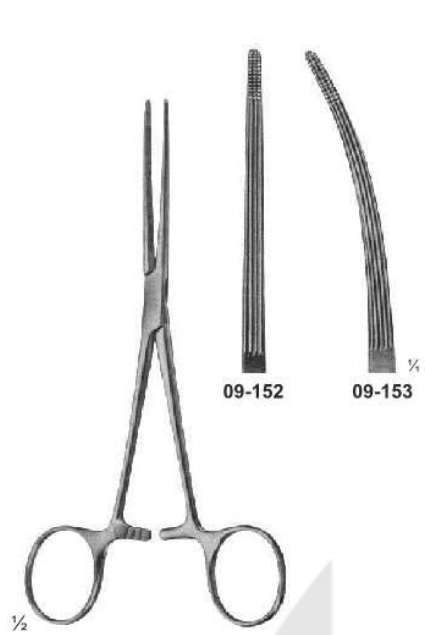

09-152 - 153
BAINBRIDGE
155 mm

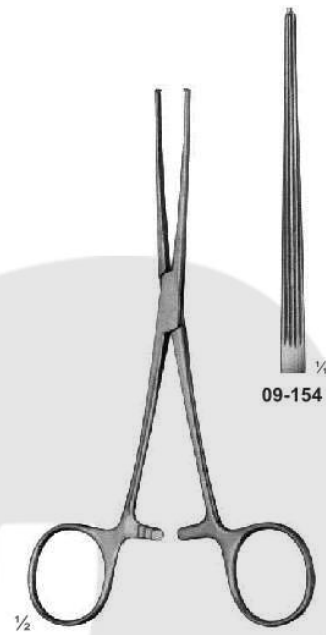

09-154
ALLEN
155 mm

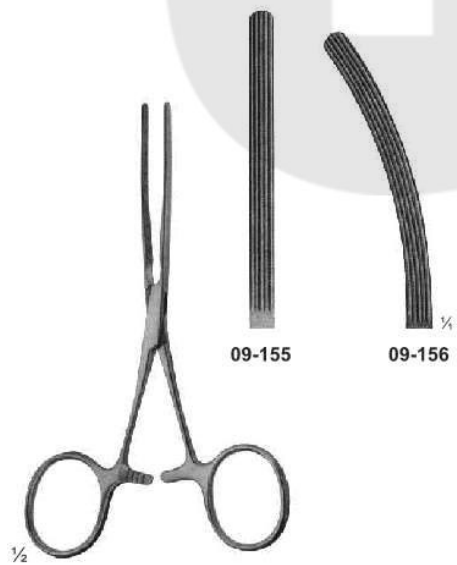

09-155 - 156
BABY-KOCHER
very elastic blades
130 mm

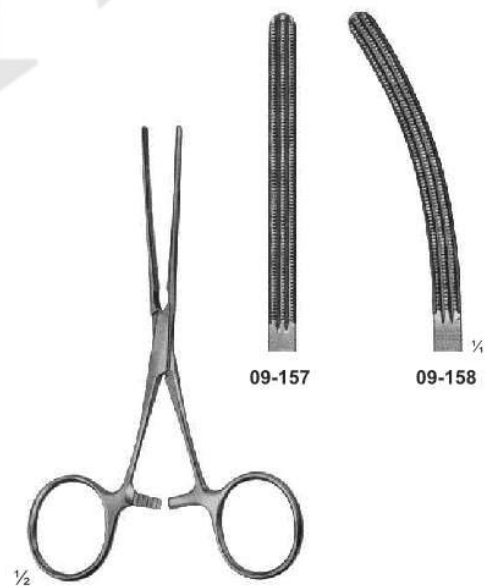

09-157 - 158
BABY-KOCHER
with elastic blades
130 mm

Intestinal Clamps, Soft Elastic

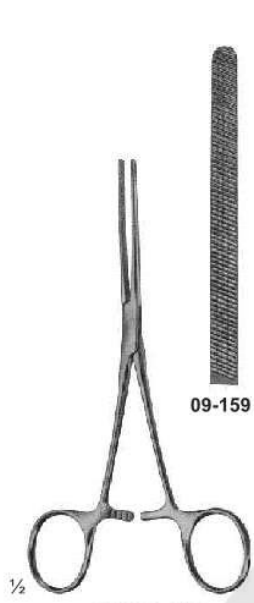

09-159 - 160
DOYEN
elastic
165 mm

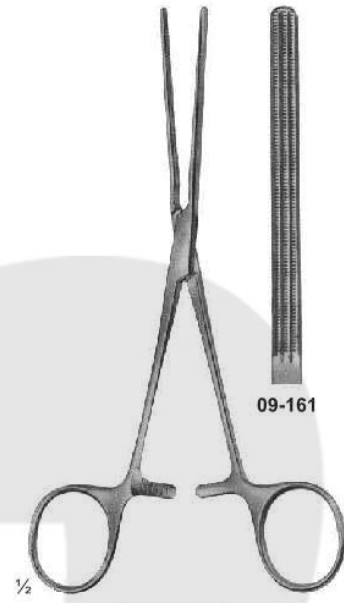

09-161 - 162
DOYEN
with elastic blades
170 mm



09-163 - 164
HARTMANN
with elastic blades
200 mm



09-165 - 166
HARTMANN
with elastic blades
200 mm

Intestinal Clamps, Soft elastic

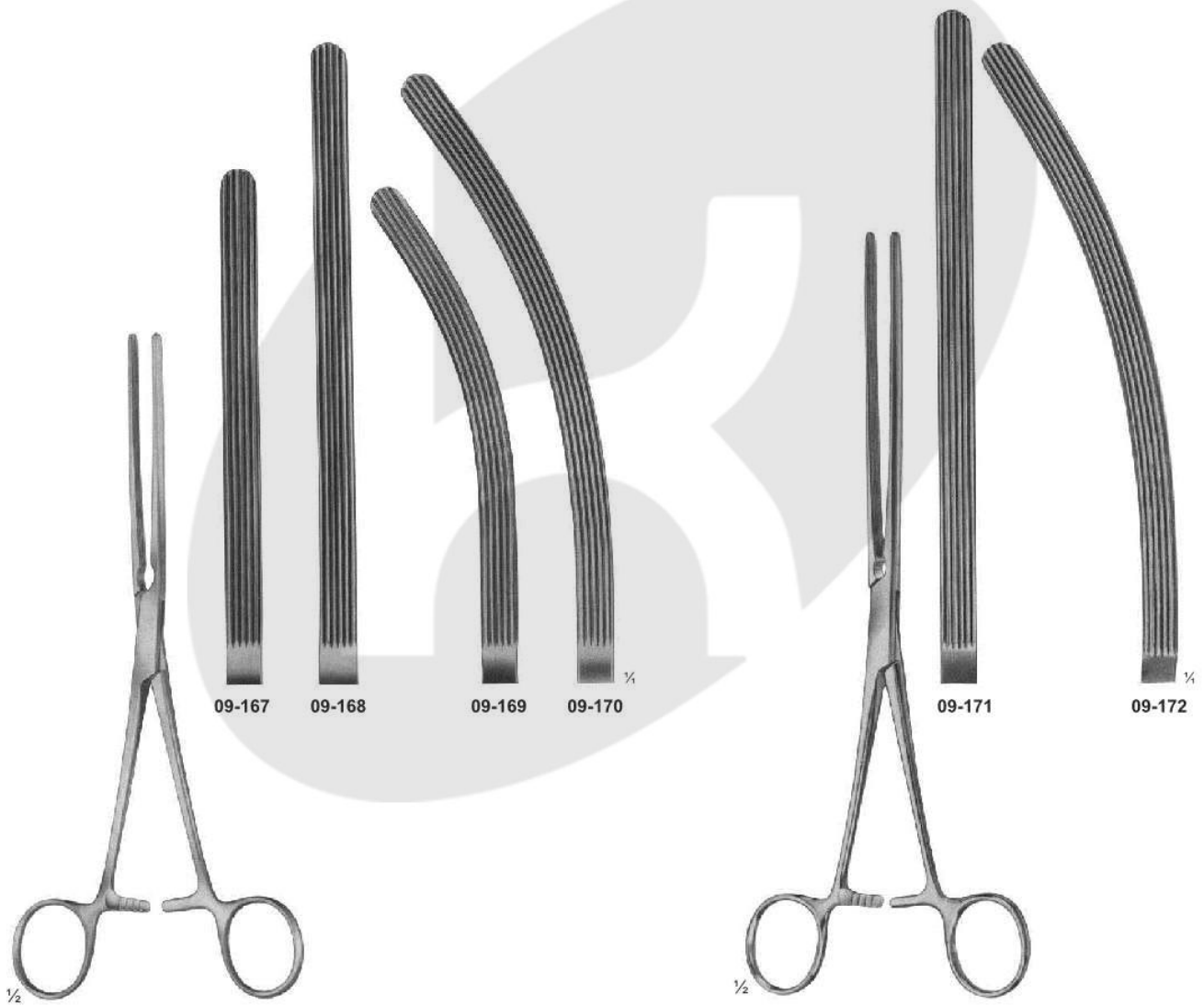

09-167 - 170
KOCHER
with elastic blades
09-169 210 mm
09-170 230 mm

09-171 - 172
DOYEN
with elastic blades
210 mm

Intestinal Clamps, Soft elastic



Intestinal Clamps, Soft elastic

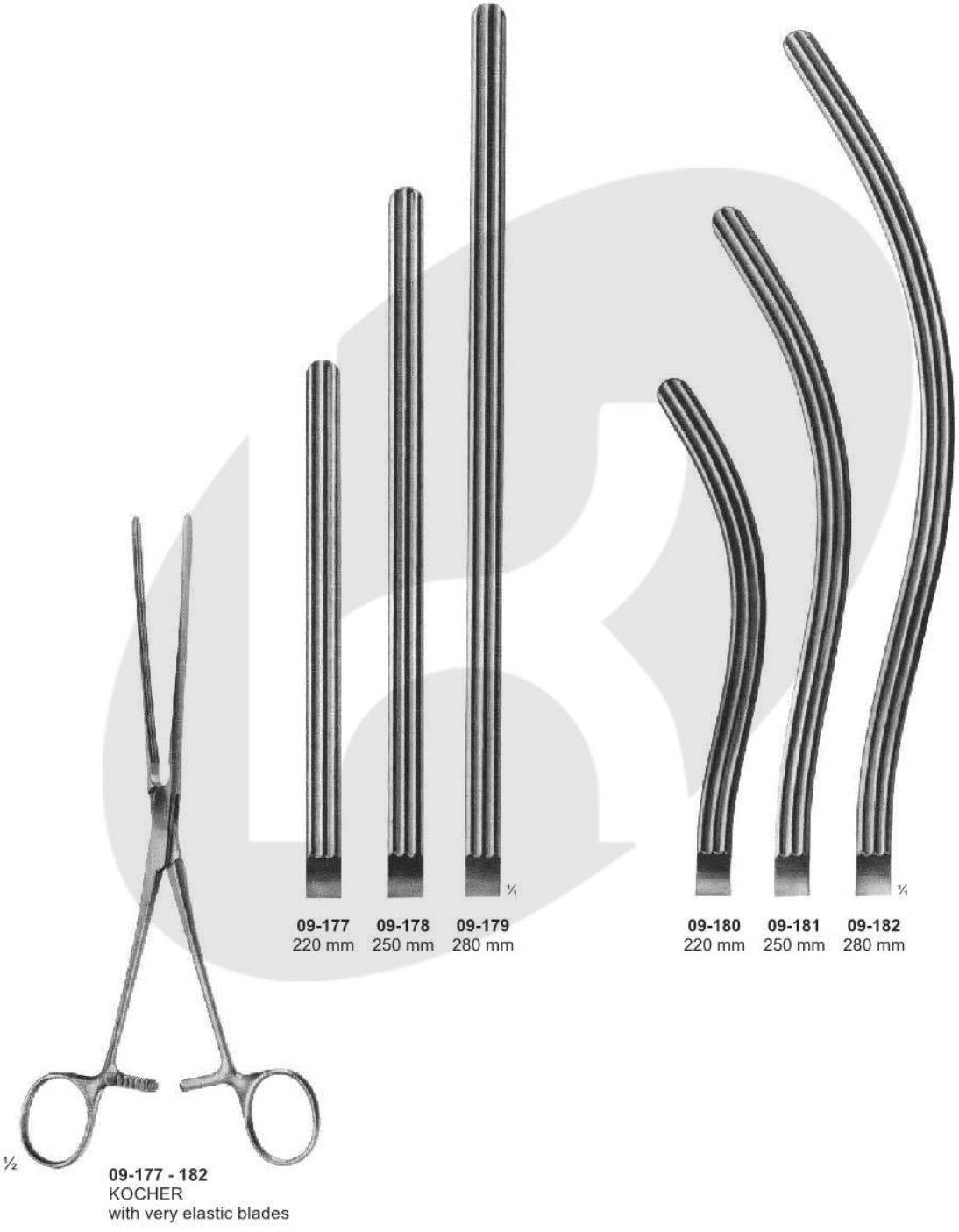

Intestinal Clamps, Soft elastic

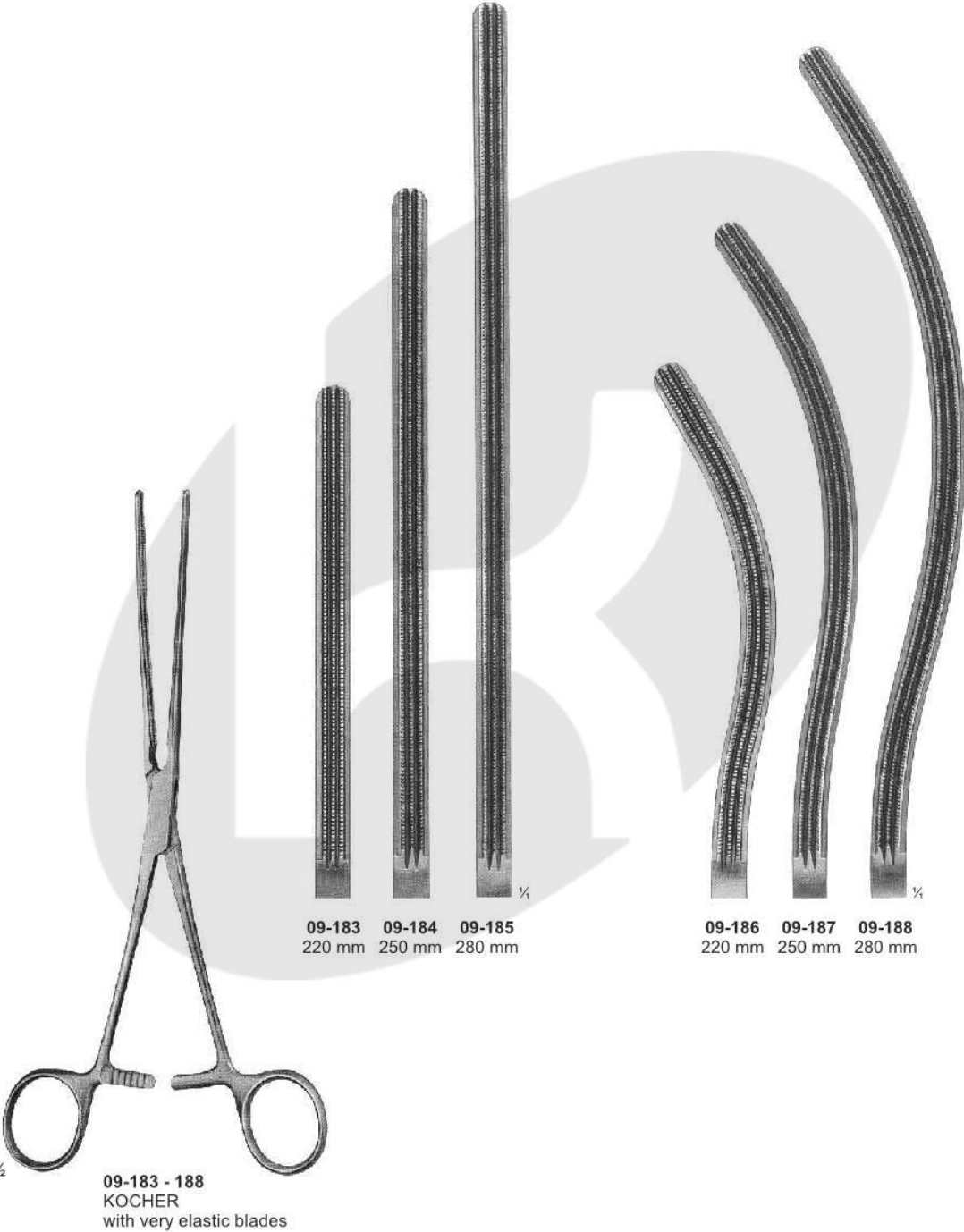

Intestinal Clamps



09-189 - 190
NUSSBAUM
with elastic blades
250 mm

09-191
MOYNIHAN
280 mm

Intestinal Clamps



Gastro-Intestinal Forceps, twin



09-196
LANE
300 mm

09-197
LANE
300 mm

Stomach Clamps



Intestinal and Pylorus Clamps



09-201
PAYR
Intestinal clamp
light pattern,
for children
180 mm

09-202
PAYR
200 mm

09-203
PAYR
275 mm

09-204
PAYR
Pylorus clamp
315 mm

Anastomosis Forceps

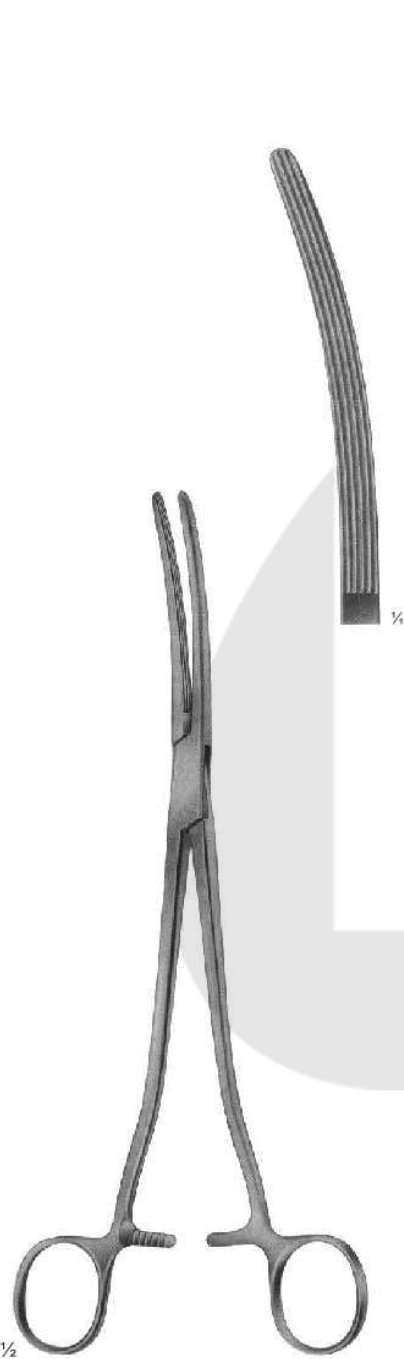

09-205
PARKER-KERR
anastomosis forceps
for colon resection
180 mm

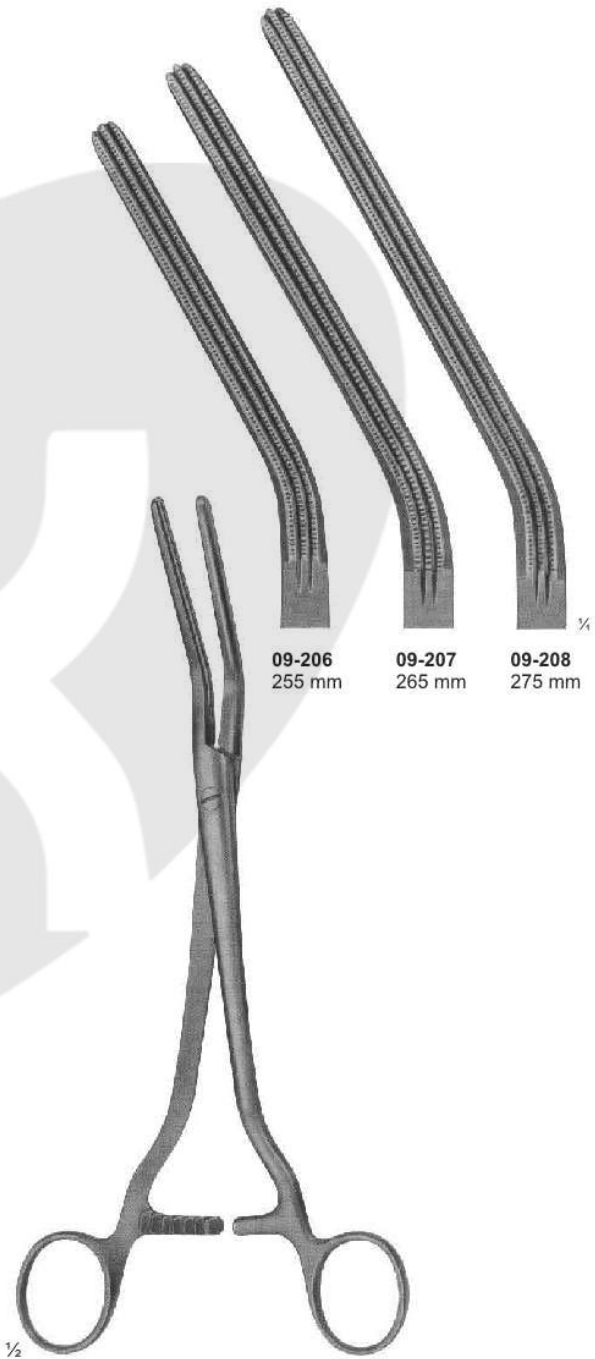

09-206
255 mm

09-207
265 mm

09-208
275 mm

09-206 - 208
DICK
pressure clamps
180 mm

Sigmoid Anastomosis Forceps

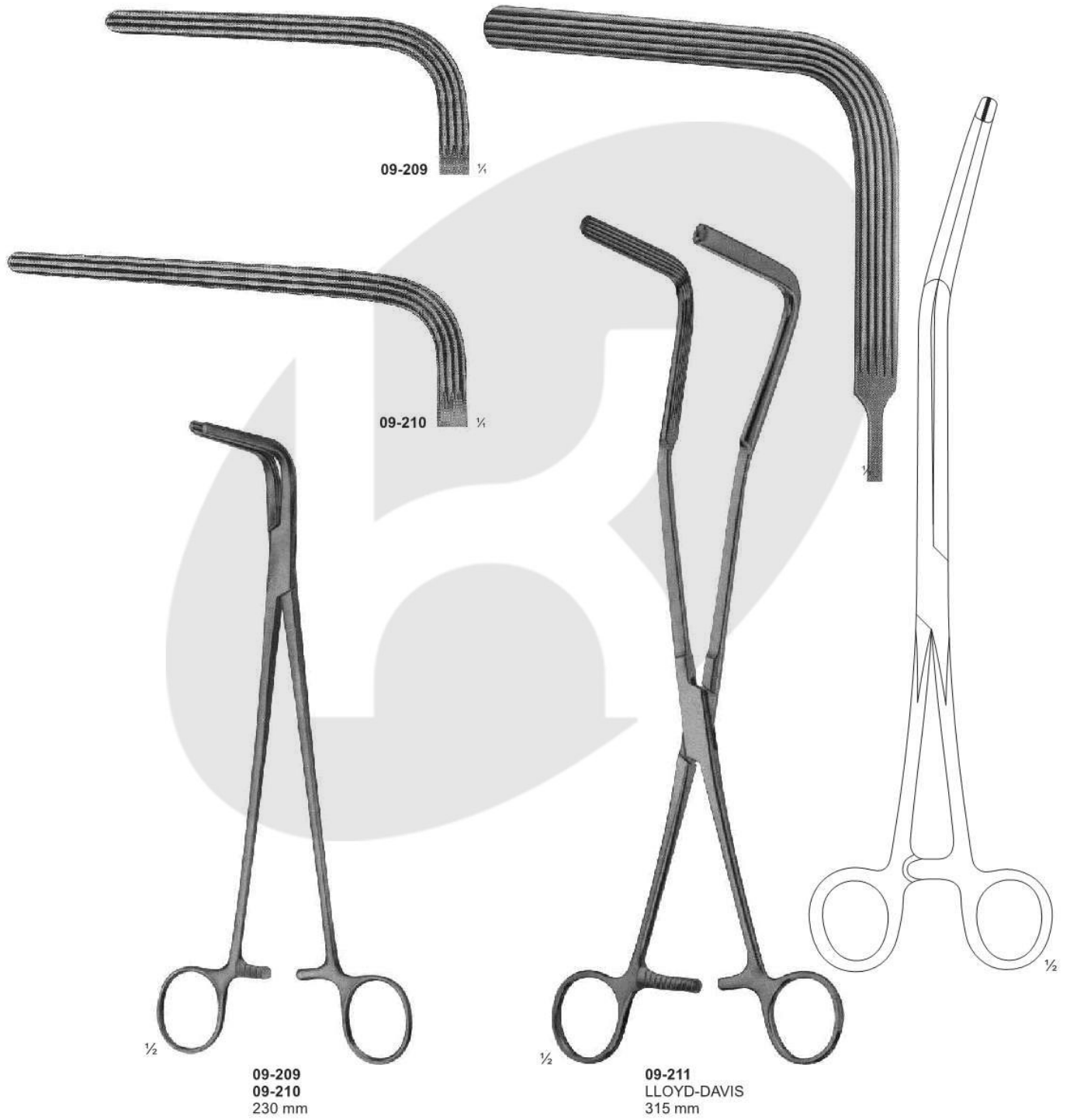

Sigmoid Anastomosis Forceps

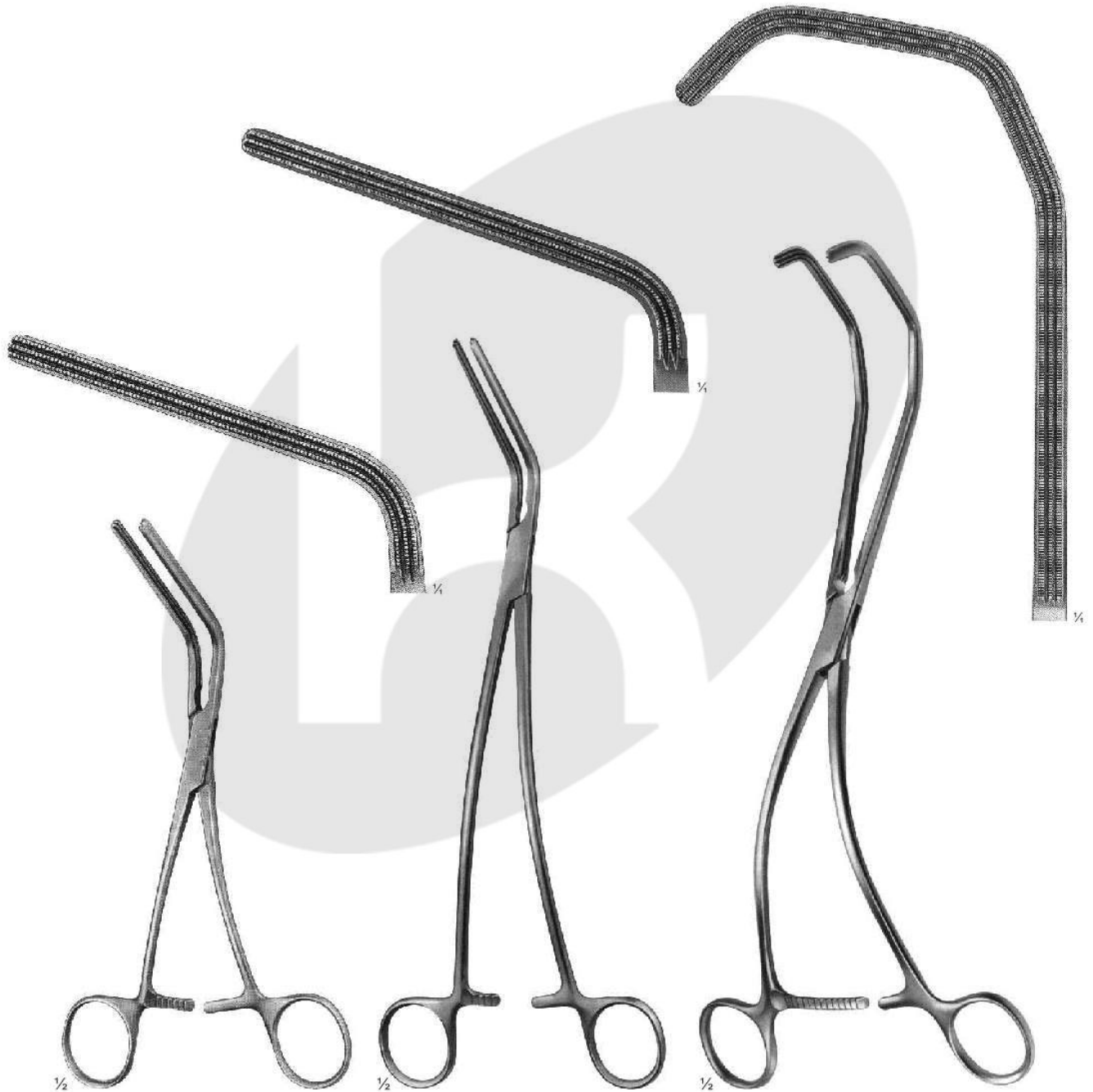

09-212
MORRIS
175 mm

09-213
DE BAKEY
(MORRIS modif.)
240 mm

09-214
KERSTING
270 mm

Rectal Specula

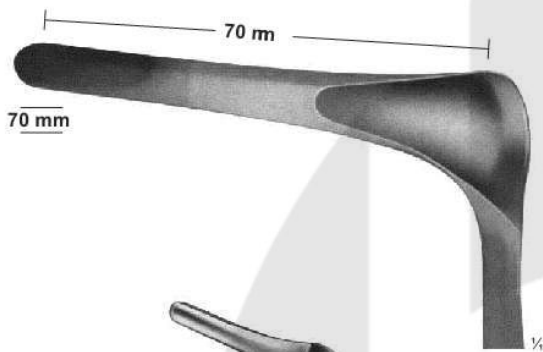

10-101
KILLIAN
for children
145 mm



10-102
SIMS
160 mm



10-103
SIMS
160 mm

Rectal Specula

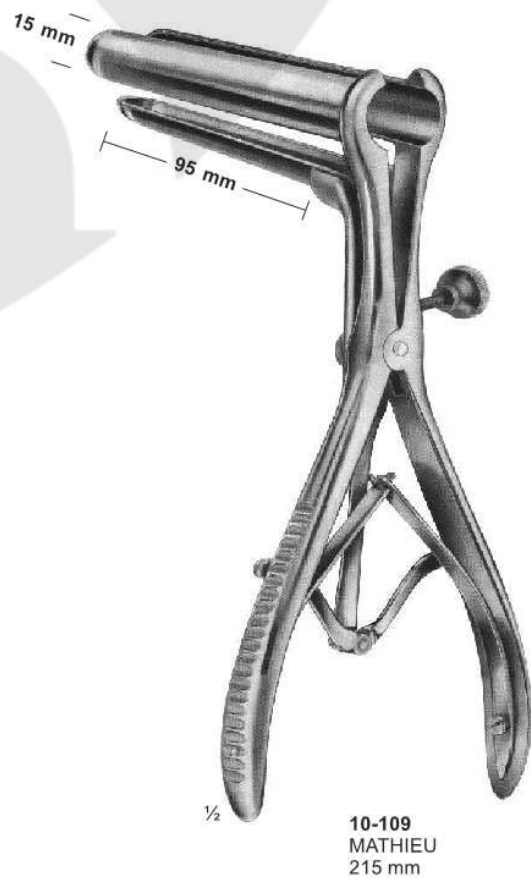
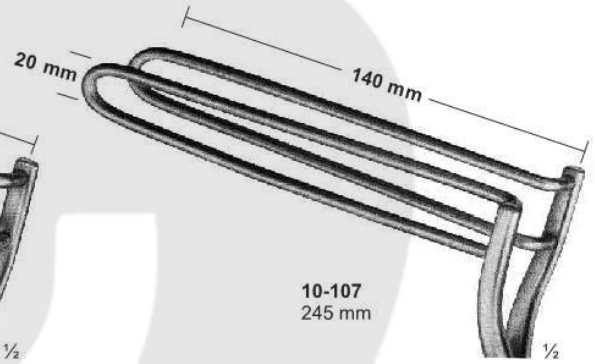
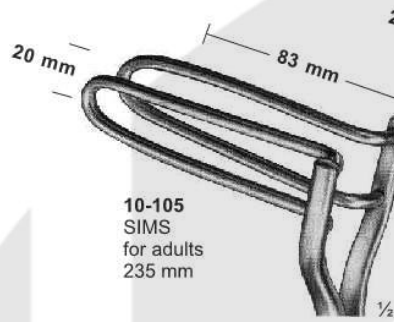
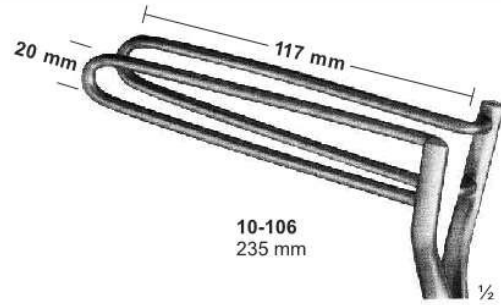
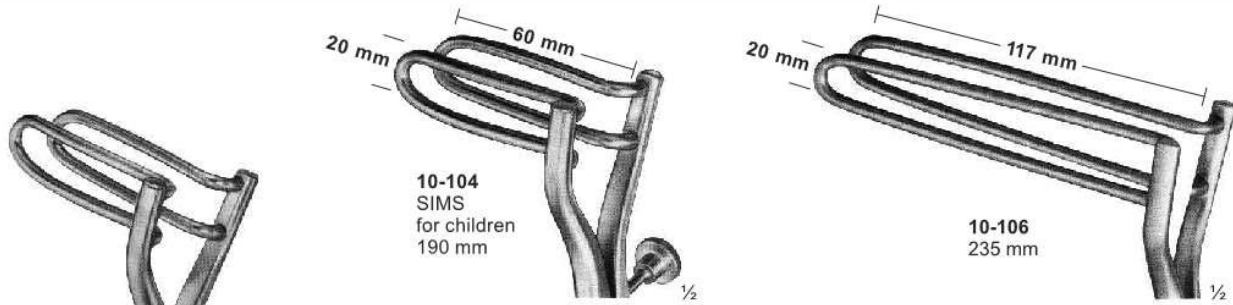

Anusscopes-Sphincteroscopes



10-110
IVES-FANSLER
Anuscope
145 mm



10-111
KELLY
Sphincteroscope
160 mm



10-112
KELLY
Sphincteroscope
160 mm

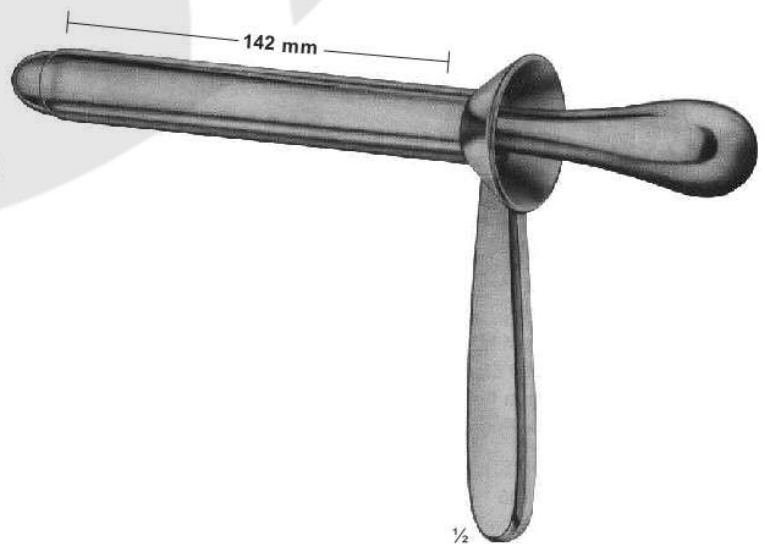

10-113
KELLY
Proctoscope
160 mm

Biopsy forceps for rectum

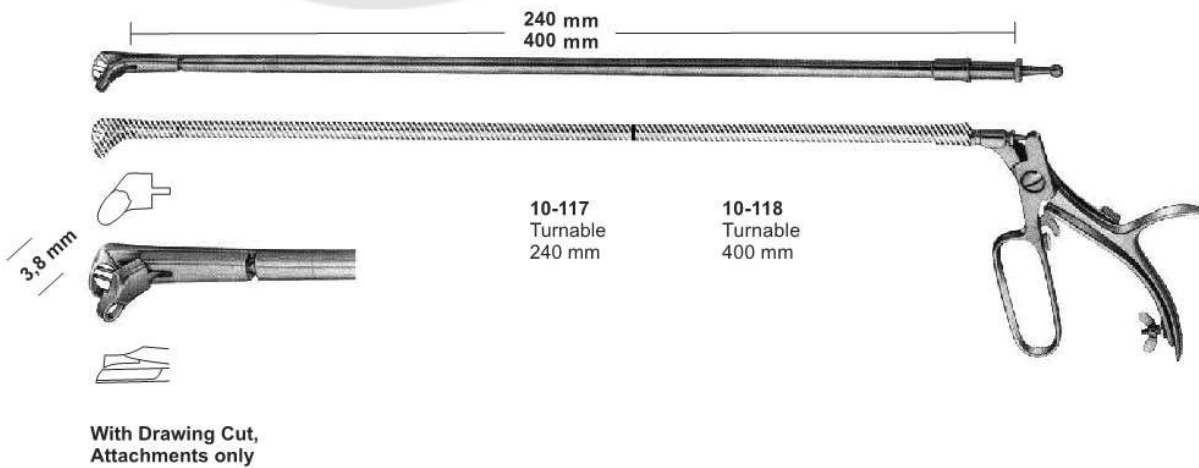
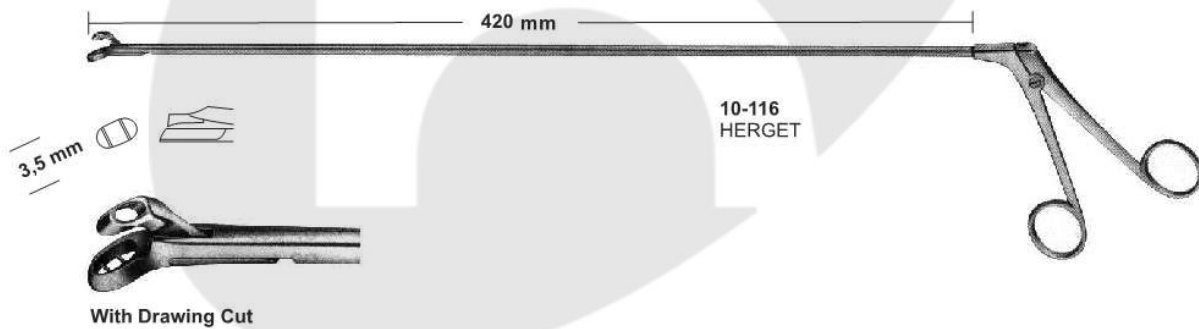
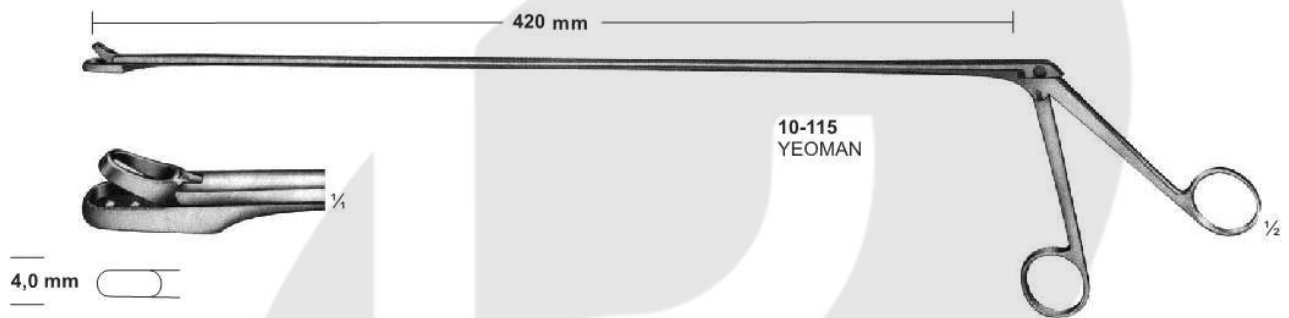
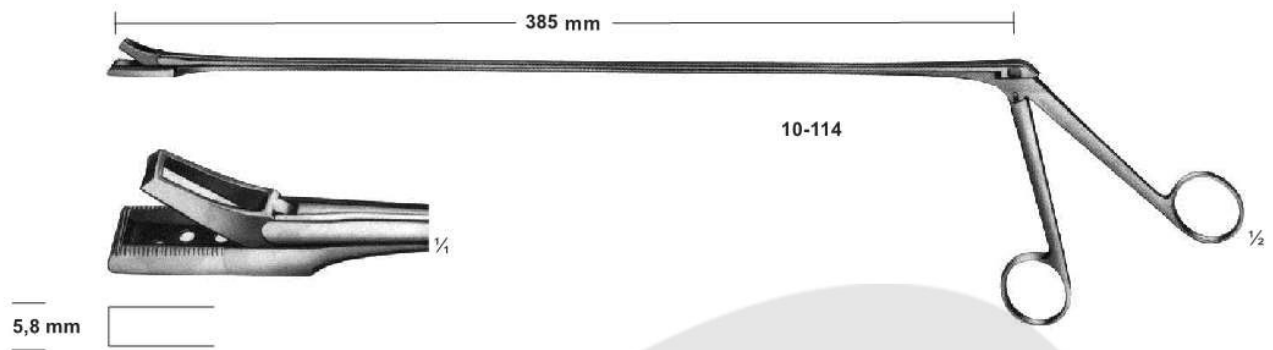

Biopsy Forceps & Swab Holders

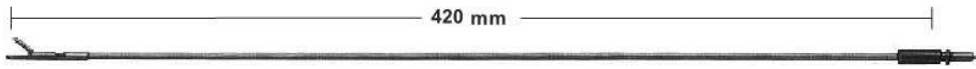

3,5 mm



10-119

3,5 mm



10-120

4,0 mm



10-121

4,0 mm



10-122



10-119 - 122
Handle for 119 - 120 - 121 - 122

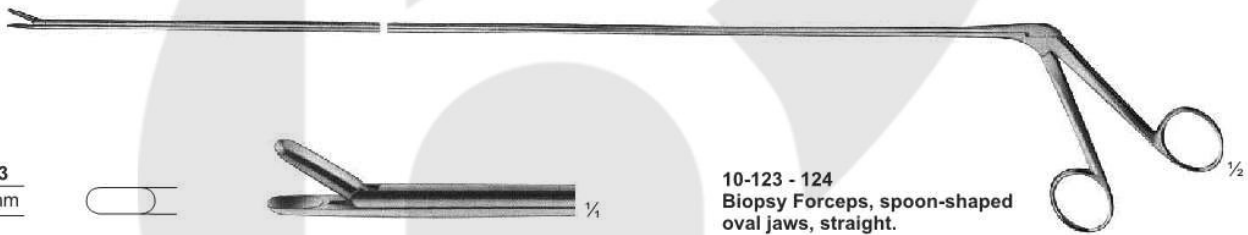

10-123

3,5 mm



10-123 - 124
Biopsy Forceps, spoon-shaped
oval jaws, straight.

10-124

4, mm

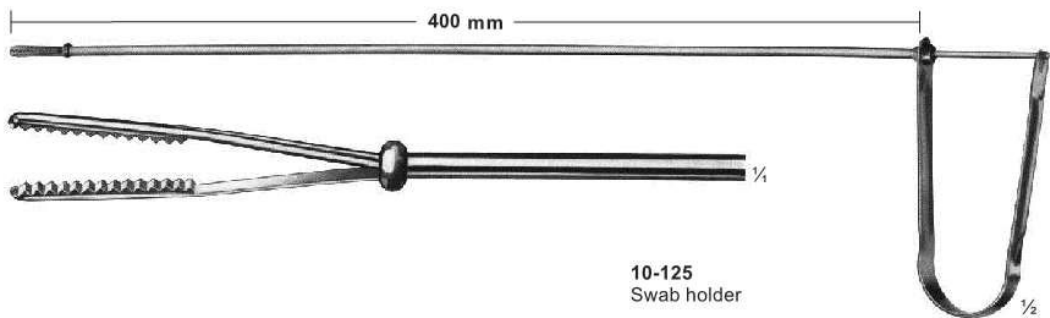

10-125
Swab holder

Haemorrhoidal Forceps



10-126 - 127
LUER

10-126
220 mm

10-127
245 mm

10-128
HEYWOOD-SMITH
200 mm

10-129
HEYWOOD-SMITH
modif
200 mm

Haemorrhoidal Forceps

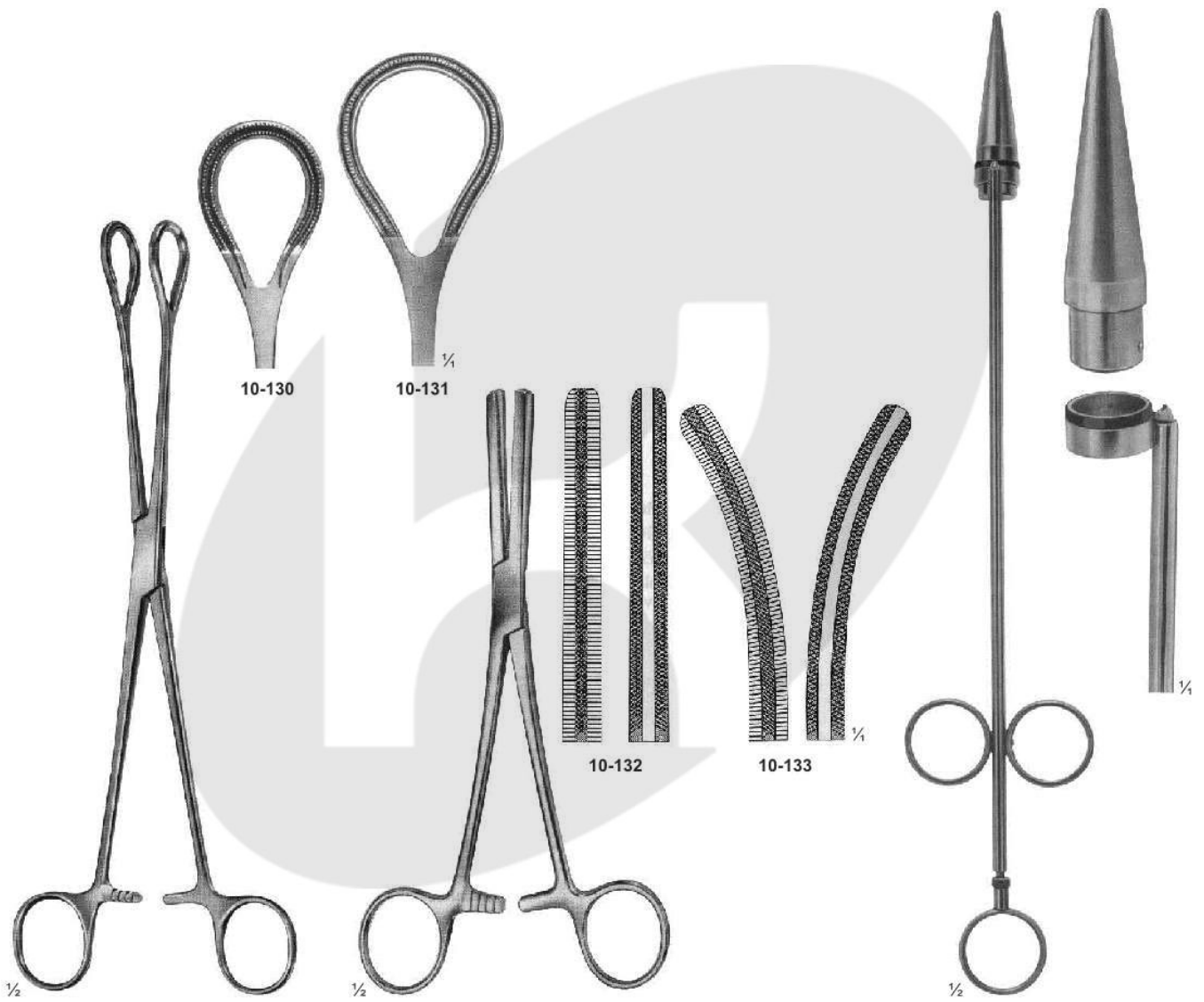

10-130 - 131
250 mm
10-131
270 mm

10-132 - 133
FERGUSSON
200 mm

10-134
RUDD
Haemorrhoidal ligator
with loading
attachment and 100
ligature rubber rings
315 mm

Gall Duct Forceps



10-135
LOWER
180 mm

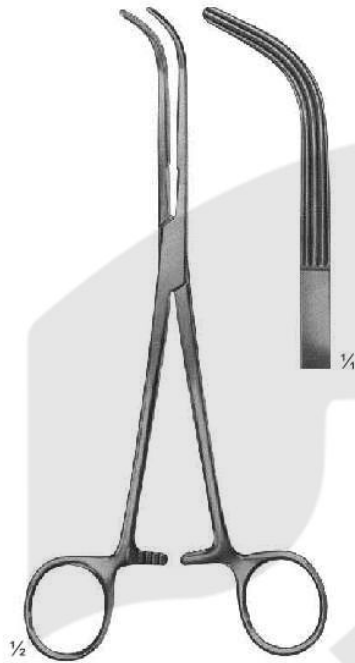

10-136
LAHEY (SWEET)
190 mm

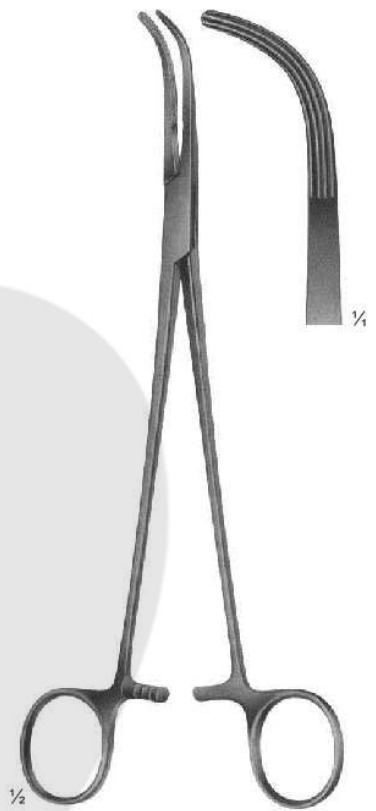

10-137
LAHEY
220 mm



10-138
DESJARDINS
Gall duct-and cystic forceps
210 mm



10-139
NISSEN
Gall duct-and cystic forceps
215 mm

Gall Duct Forceps and Choledochus Forceps

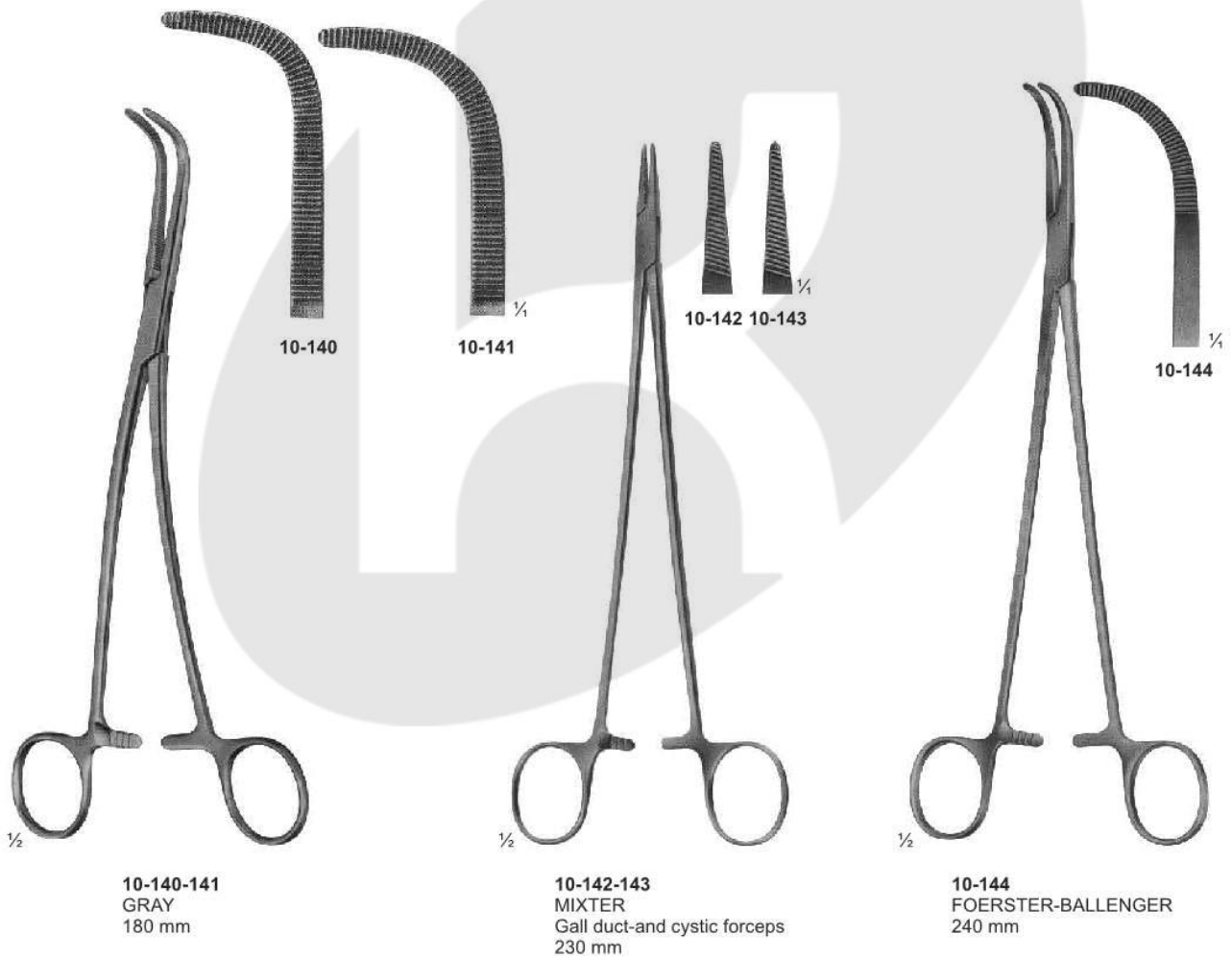

Gall Bladder Forceps and Gall Duct Scissors



Gall Duct Probes

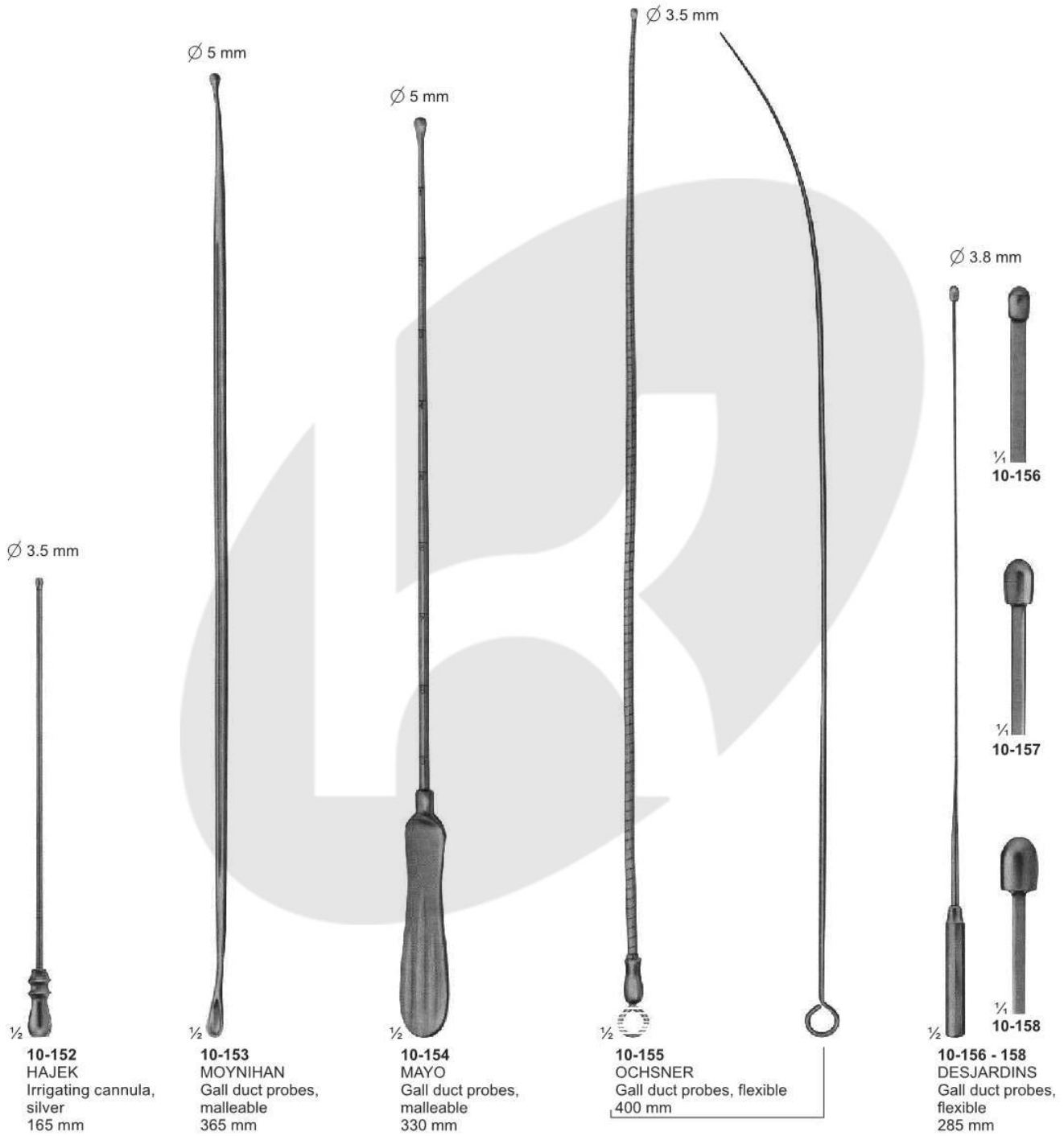

Gall Duct Dilators & Gall Stone Scoops

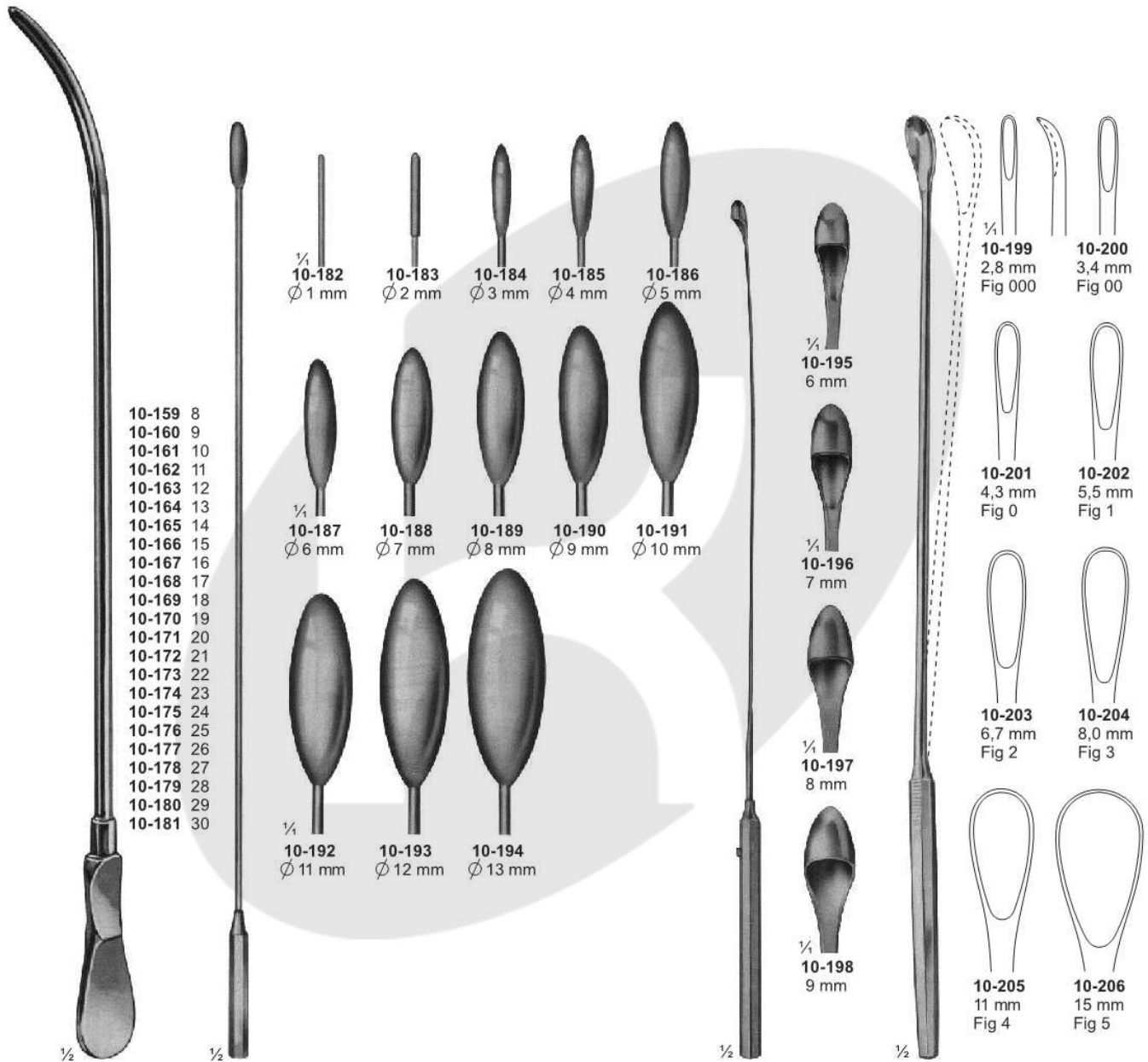

- 10-159 8
- 10-160 9
- 10-161 10
- 10-162 11
- 10-163 12
- 10-164 13
- 10-165 14
- 10-166 15
- 10-167 16
- 10-168 17
- 10-169 18
- 10-170 19
- 10-171 20
- 10-172 21
- 10-173 22
- 10-174 23
- 10-175 24
- 10-176 25
- 10-177 26
- 10-178 27
- 10-179 28
- 10-180 29
- 10-181 30

- 1/4 10-182
Ø 1 mm
- 10-183
Ø 2 mm
- 10-184
Ø 3 mm
- 10-185
Ø 4 mm
- 10-186
Ø 5 mm
- 1/4 10-187
Ø 6 mm
- 10-188
Ø 7 mm
- 10-189
Ø 8 mm
- 10-190
Ø 9 mm
- 10-191
Ø 10 mm
- 1/4 10-192
Ø 11 mm
- 10-193
Ø 12 mm
- 10-194
Ø 13 mm

- 1/4 10-195
6 mm
- 1/4 10-196
7 mm
- 1/4 10-197
8 mm
- 1/4 10-198
9 mm

- 1/4 10-199
2,8 mm
Fig 000
- 10-200
3,4 mm
Fig 00
- 10-201
4,3 mm
Fig 0
- 10-202
5,5 mm
Fig 1
- 10-203
6,7 mm
Fig 2
- 10-204
8,0 mm
Fig 3
- 10-205
11 mm
Fig 4
- 10-206
15 mm
Fig 5

10-159 - 181
DITTEL
Metall bougies and
dilating sounds, stiff
345 mm

10-182 - 194
BAKES
Common bile duct
dilators, malleable
315 mm, 320 mm

10-195 - 198
DESJARDINS
Probes and catch
with flexible shaft
300 mm

10-199 - 206
LUER-KORTE modif
with malleable shaft
310 mm

Gall Stone Forceps

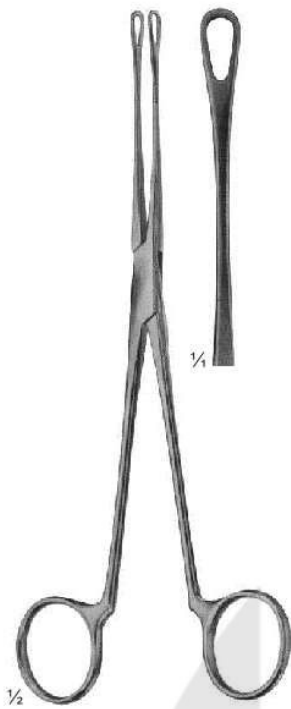

10-207
BLAKE
205 mm

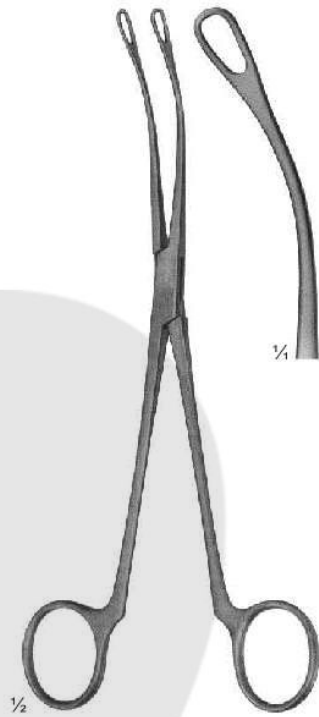

10-208
BLAKE
205 mm

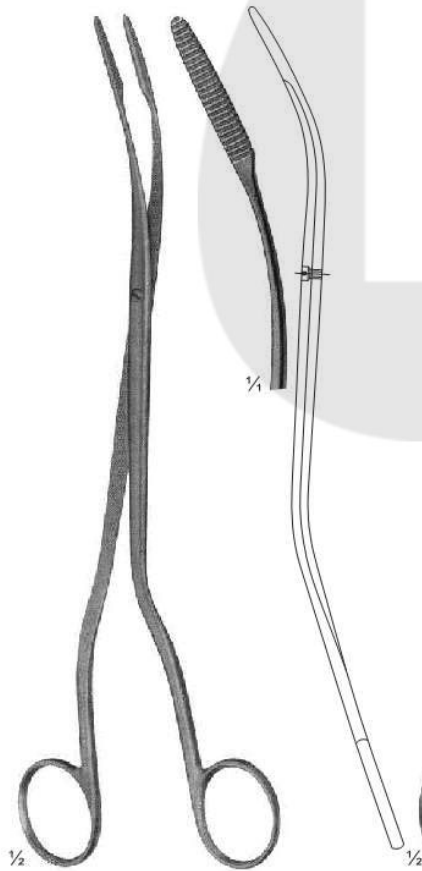

10-209
CZERNY
245 mm

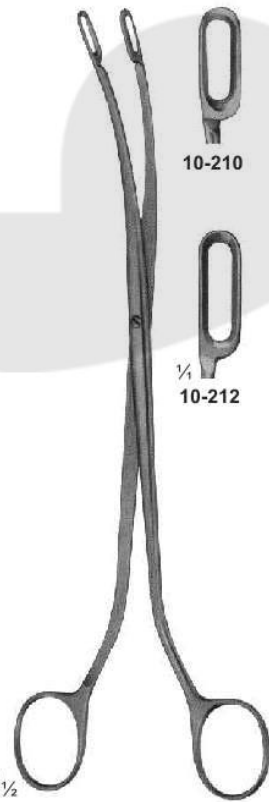

10-210 - 213
DESJARDINS
225 mm



10-210 **10-211**
10-212 **10-213**



10-214 - 215
DESJARDINS
Extremely delicate patterns

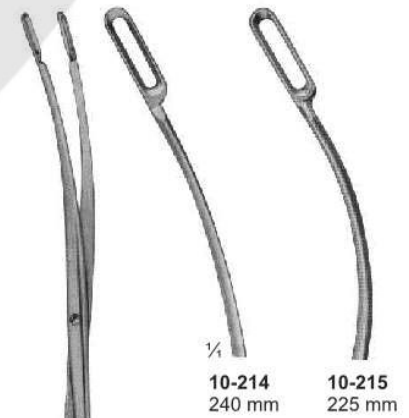

10-214 **10-215**
240 mm 225 mm

Kidney Clamps

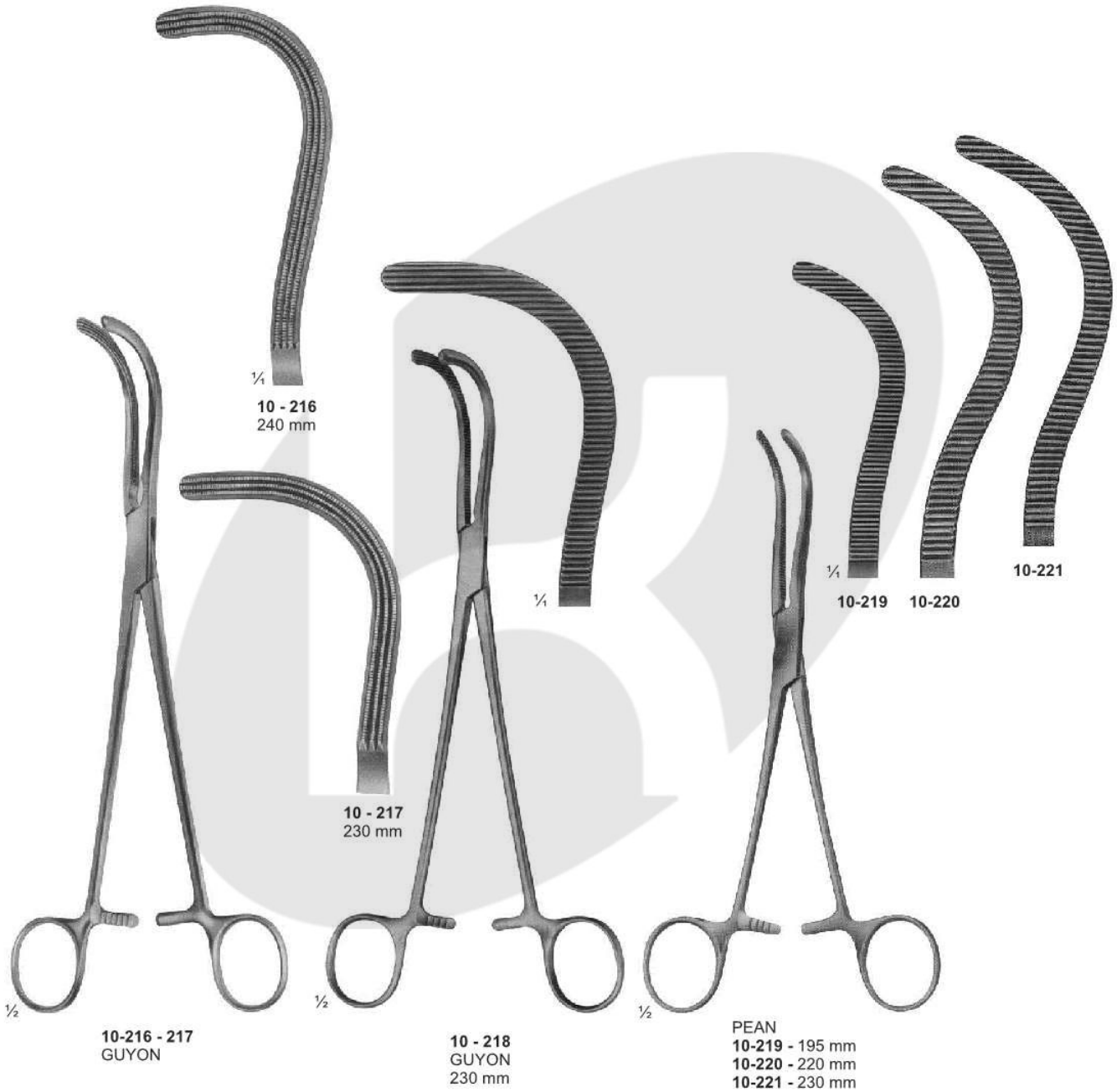

Kidney Clamps

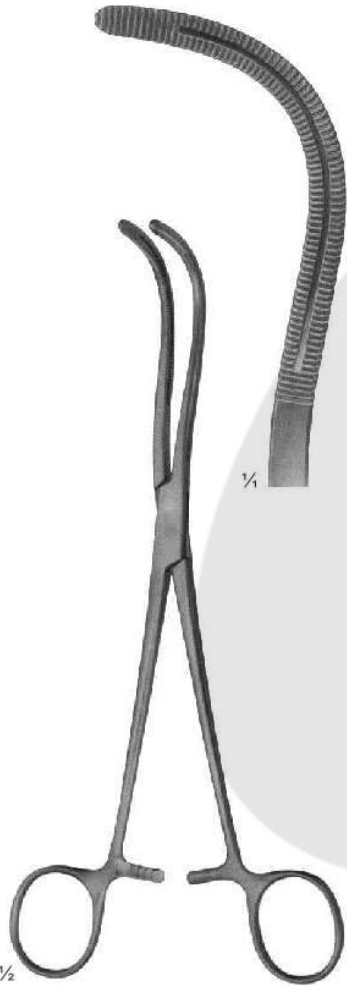

10-222
STILLE
220 mm

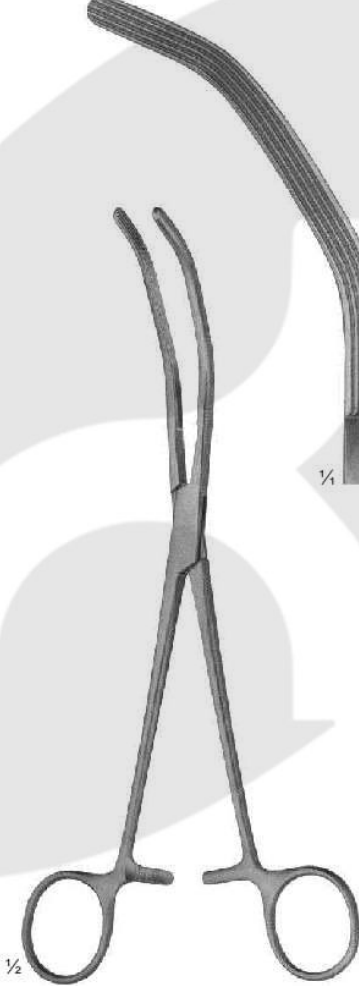

10-223
HERRICK
225 mm



10-224
WERTHEIM
225 mm

Kidney Elevating Forceps

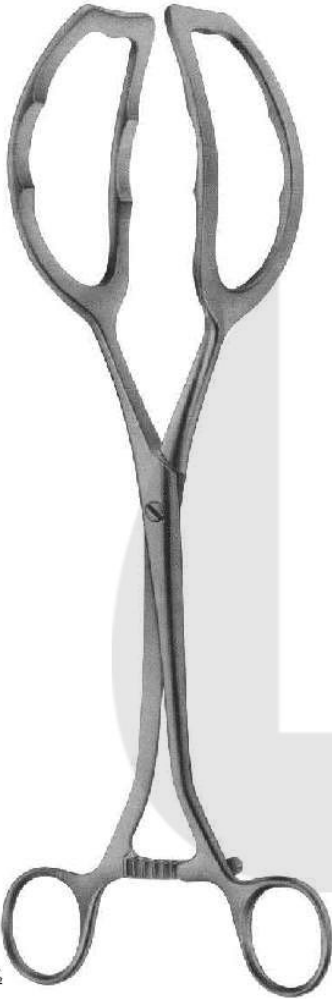

½

10-225
COLLIN
285 mm



½

10-226
DARTIGUES
255 mm

Kidney Stone Forceps

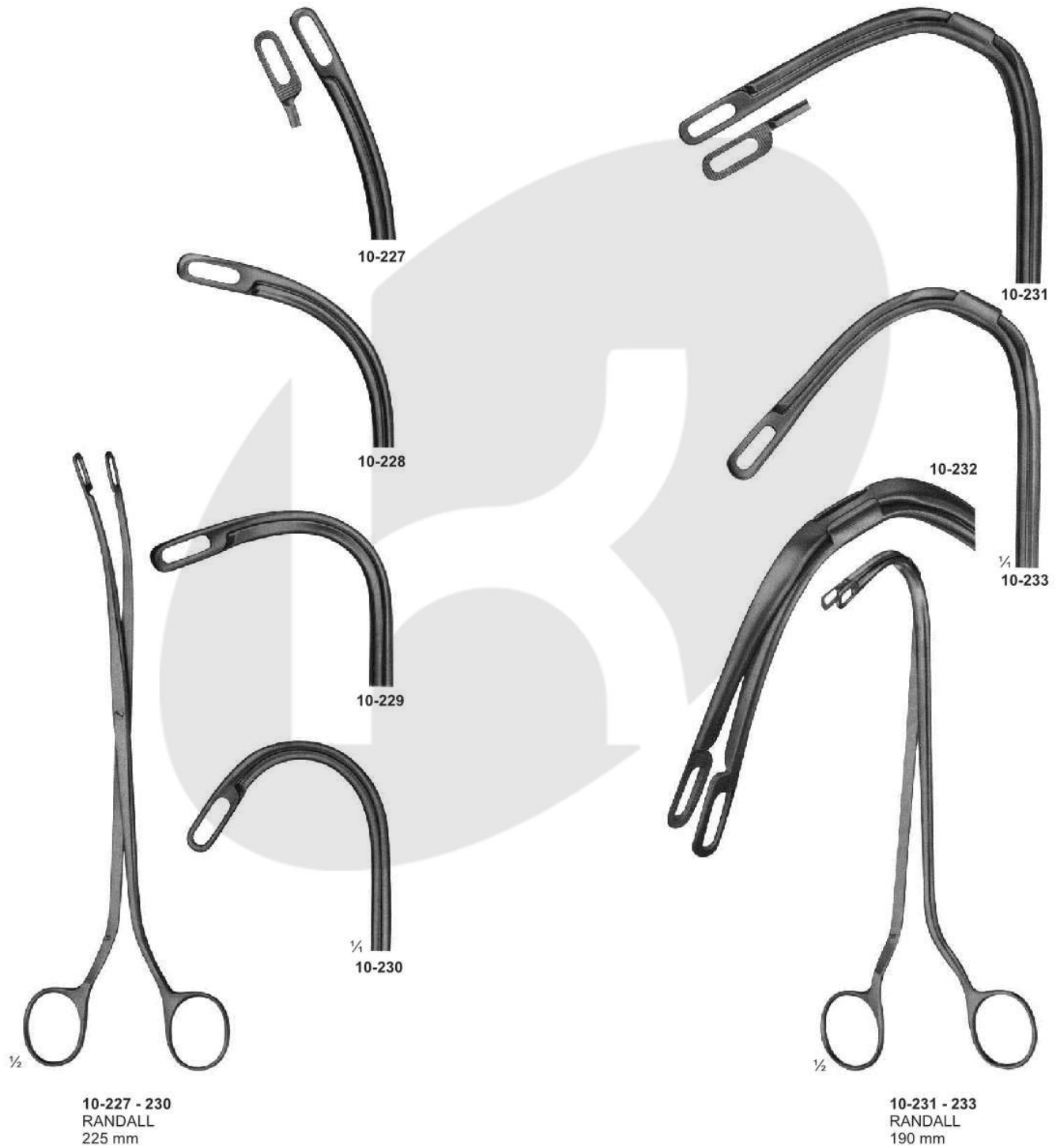

Bladder Retractors

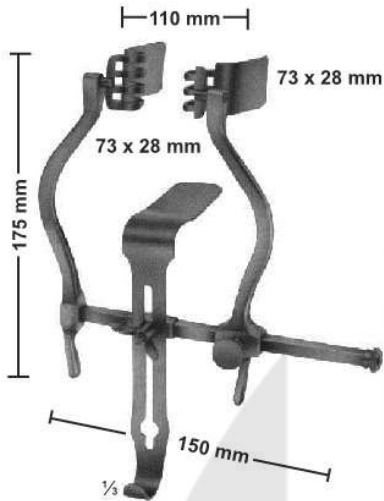

11-101
JUDD-MASSON
Bladder-and suprapubic
retractor



11-102
MILLIN
Bladder retractor
105X45 mm



11-103
LEGUEU
Bladder retractor
Center blade
80 x 31 mm

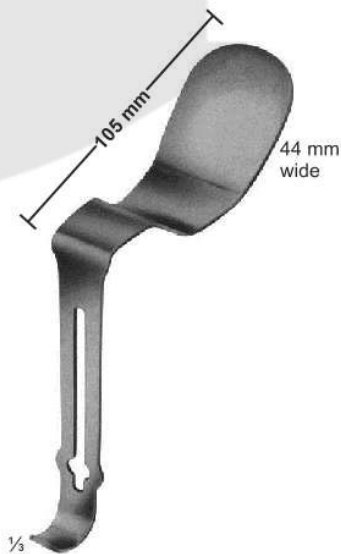

11-104
MILLIN
Center bladder for
retro pubic prostatectomy

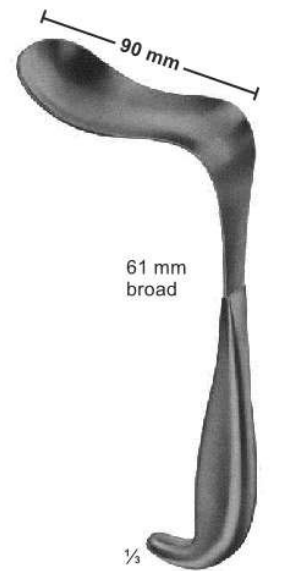

11-105
KOCHER
Bladder spatula
235 mm

Genito-Urinary Instruments-Prostatectomy



11-106
MATHIEU
Foreign body forceps
Length of shaft
190 mm

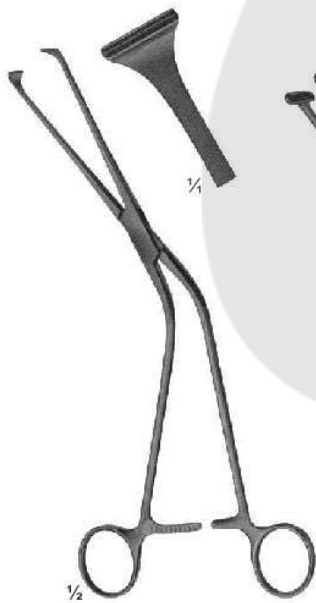

11-107
MILLIN
Lobe grasping
forceps
245 mm

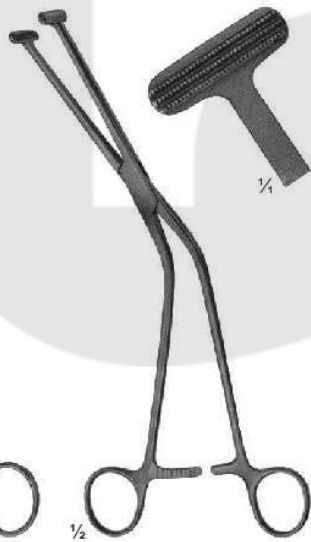

11-108
MILLIN
Lobe grasping
forceps
235 mm



11-109
MILLIN
Bladder neck spreader
285 mm



11-110
Ureter forceps
240 mm

Genito-Urinary Instruments



11-111
GUYON
Catheter guide
(introducer)
365 mm

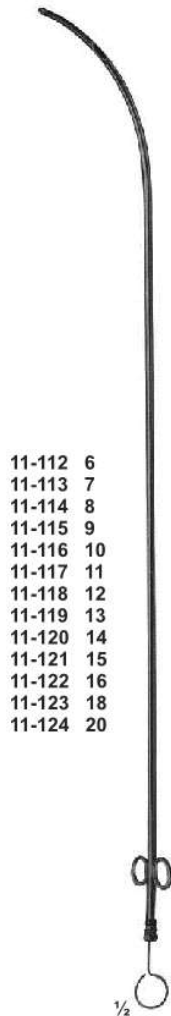

- 11-112 6
- 11-113 7
- 11-114 8
- 11-115 9
- 11-116 10
- 11-117 11
- 11-118 12
- 11-119 13
- 11-120 14
- 11-121 15
- 11-122 16
- 11-123 18
- 11-124 20

11-112 - 124
Female catheters,
metal
160 mm

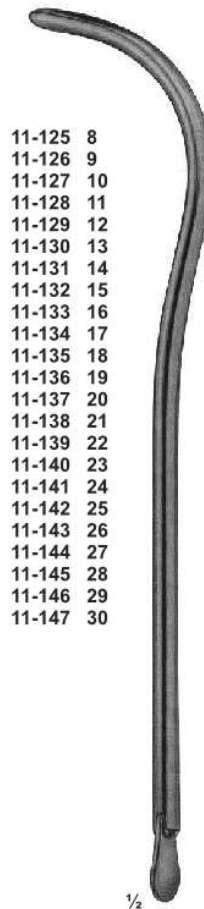

- 11-125 8
- 11-126 9
- 11-127 10
- 11-128 11
- 11-129 12
- 11-130 13
- 11-131 14
- 11-132 15
- 11-133 16
- 11-134 17
- 11-135 18
- 11-136 19
- 11-137 20
- 11-138 21
- 11-139 22
- 11-140 23
- 11-141 24
- 11-142 25
- 11-143 26
- 11-144 27
- 11-145 28
- 11-146 29
- 11-147 30

11-125 - 147
Urethral bougies
and dilating sounds
345 mm

- 11-148 Ben. 24/Charr. 12
- 11-149 Ben. 25
- 11-150 Ben. 26/Charr. 13
- 11-151 Ben. 27
- 11-152 Ben. 28/Charr. 14
- 11-153 Ben. 29
- 11-154 Ben. 30/Charr. 15
- 11-155 Ben. 31
- 11-156 Ben. 32/Charr. 16
- 11-157 Ben. 33
- 11-158 Ben. 34/Charr. 17
- 11-159 Ben. 35
- 11-160 Ben. 36/Charr. 18
- 11-161 Ben. 37
- 11-162 Ben. 38/Charr. 19
- 11-163 Ben. 39
- 11-164 Ben. 40/Charr. 20
- 11-165 Ben. 41
- 11-166 Ben. 42/Charr. 21
- 11-167 Ben. 43
- 11-168 Ben. 44/Charr. 22
- 11-169 Ben. 45
- 11-170 Ben. 46/Charr. 23
- 11-171 Ben. 47
- 11-172 Ben. 48/Charr. 24
- 11-173 Ben. 49
- 11-174 Ben. 50/Charr. 25
- 11-175 Ben. 51
- 11-176 Ben. 52/Charr. 26
- 11-177 Ben. 53
- 11-178 Ben. 54/Charr. 27
- 11-179 Ben. 55
- 11-180 Ben. 56/Charr. 28
- 11-181 Ben. 57
- 11-182 Ben. 58/Charr. 29
- 11-183 Ben. 59
- 11-184 Ben. 60/Charr. 30



11-148 - 184
Urethral bougies
and dilating sounds
255 mm

Genito-Urinary Instruments & Circumcision Clamps



11-185
GUYON
Set of urethral bougies and dilating sounds,
in metal case, with lift out rack and bottom
rack, containing 21 urethral and dilating sounds.

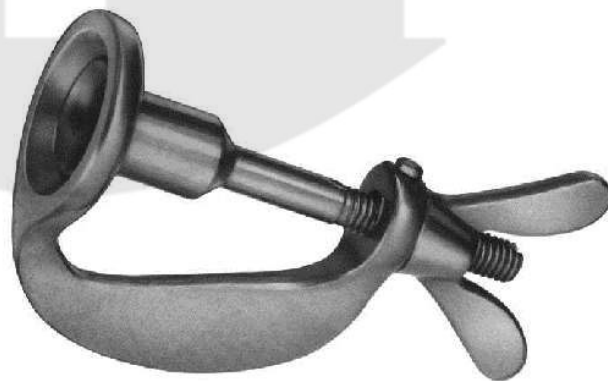

11-186
WINKELMANN
Circumcision Clamps
12 mm / 16 mm / 20 mm

Trocars



11-187
KLIMA ROSEGGER
35 X 1,8 mm
Sternal puncture needle

11-188
Universal trocar
with 4 tips

ϕ 6,0 mm
 ϕ 4,5 mm
 ϕ 3,3 mm
 ϕ 1,9 mm

11-189 - 193
Inside dime. Outside dime
11-189 2,2 mm 3,0 mm
11-190 3,0 mm 4,0 mm
11-191 4,0 mm 5,0 mm
11-192 5,0 mm 6,0 mm
11-193 5,5 mm 6,5 mm
 for hydrocele and abdominal puncture

11-194 - 197
Inside dime. Outside dime
11-194 2,2 mm 3,0 mm
11-195 3,0 mm 4,0 mm
11-196 4,0 mm 5,0 mm
11-197 5,0 mm 6,0 mm
 for abdominal puncture,
 with stop-cock and lateral
 drain

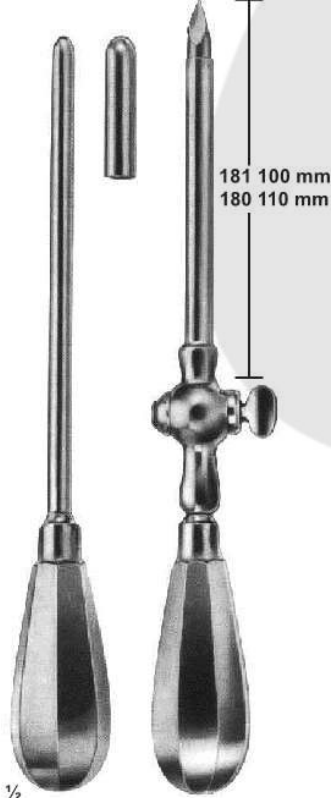

11-198 - 199
Inside dime. Outside dime
11-198 6,5 mm 8,0 mm
11-199 9,0 mm 10,0 mm
 Empyema trocar

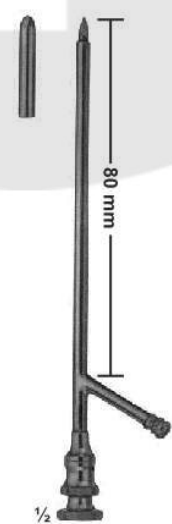

11-200 - 203
Inside dime. Outside dime
11-200 3,0 mm 4,0 mm
11-201 3,6 mm 4,6 mm
11-202 4,3 mm 5,3 mm
11-203 5,0 mm 6,0 mm
 Gall bladder trocars



11-204
PIERCE
Antrum trocar
4,0 mm



11-205
COAKLEY
Antrum trocar
3,0 mm

Vaginal specula

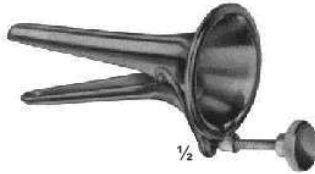

12-101
COLLIN
for children
53 x 10 mm

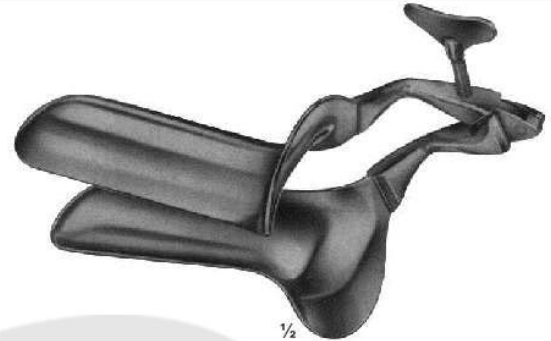

12-102 - 105
COLLIN

12-102	100/90mm	28 mm
12-103	100/90mm	32 mm
12-104	105/95mm	35 mm
12-105	115/105mm	40 mm
Total length/working length		width



12-106
COLLIN
for virgins
95/85 x 18 mm

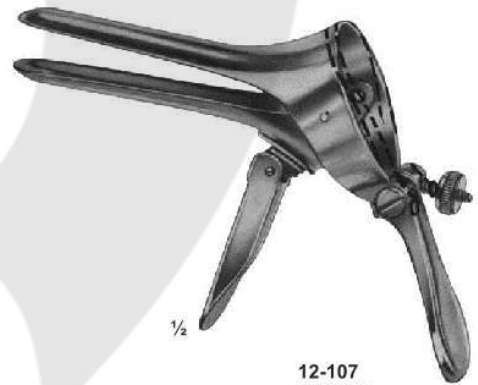

12-107
CUSCO
for virgins
75 x 17 mm



12-108
CUSCO
for virgins
75 x 17 mm

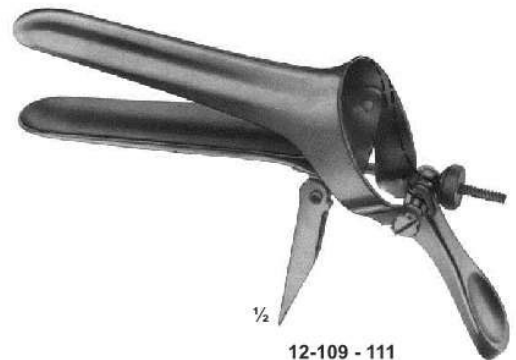

12-109 - 111
CUSCO

12-109	92X23-25 mm
12-110	100x25-27 mm
12-111	110x27-30 mm

Vaginal Specula



1/2

12-112 - 115
CUSCO
STANDARD
12-112 80X24 mm
12-113 80X32 mm
12-114 90X36 mm
12-115 110X37 mm



1/2

12-116 - 119
CUSCO
12-116 80X24 mm
12-117 80X32 mm
12-118 90X36 mm
12-119 110X37 mm



1/2

12-120 - 122
CUSCO
12-120 80X24 mm
12-121 80X32 mm
12-122 115X36 mm

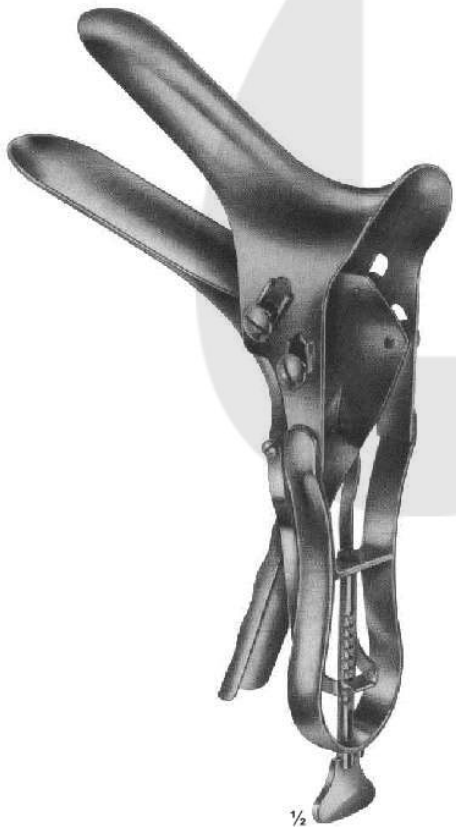

1/2

12-123 - 124
SEYFFERT
12-123 100X24 mm
12-124 110X32 mm
230 mm



1/2

12-125
SEMM
for children
and virgins
180 mm

Vaginal Specula, Sets, Upper & Lower Blades



12-126 - 128
GRAVE
12-126 75X20 mm
12-127 95X30 mm
12-128 105X33 mm

1/2

12-129 - 130
PEDERSON
12-129 100X22 mm
12-130 120X25 mm

1/2

12-131 - 132
BRIESKY
12-131 72X25 mm / 77X30 mm
12-132 75X30 mm / 92X38 mm
170 mm

1/2



1/2

12-133 - 134
BREISKY
12-133 100X22 mm
77 X30 mm
140 mm
12-134 120X25 mm
92 X38 mm
170 mm

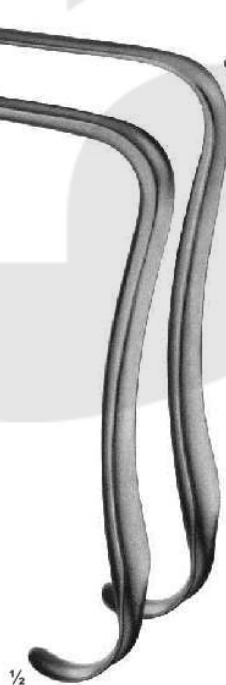

1/2

12-135 - 137
SEIDL
12-135 80X8 mm
12-136 80X10 mm
12-137 90X14 mm
For children and infants
170 mm



1/2

12-138
KRISTELLER
70X15 mm, (170 mm)
For children



1/2

12-139 - 141
SIMS
12-139 70X26 mm
75 X30 mm 125 mm
12-140 75X30 mm
80 X85 mm 150 mm
11-141 80X36 mm
90 X40 mm 175 mm

Vaginal Specula-Sets, upper and lower blades

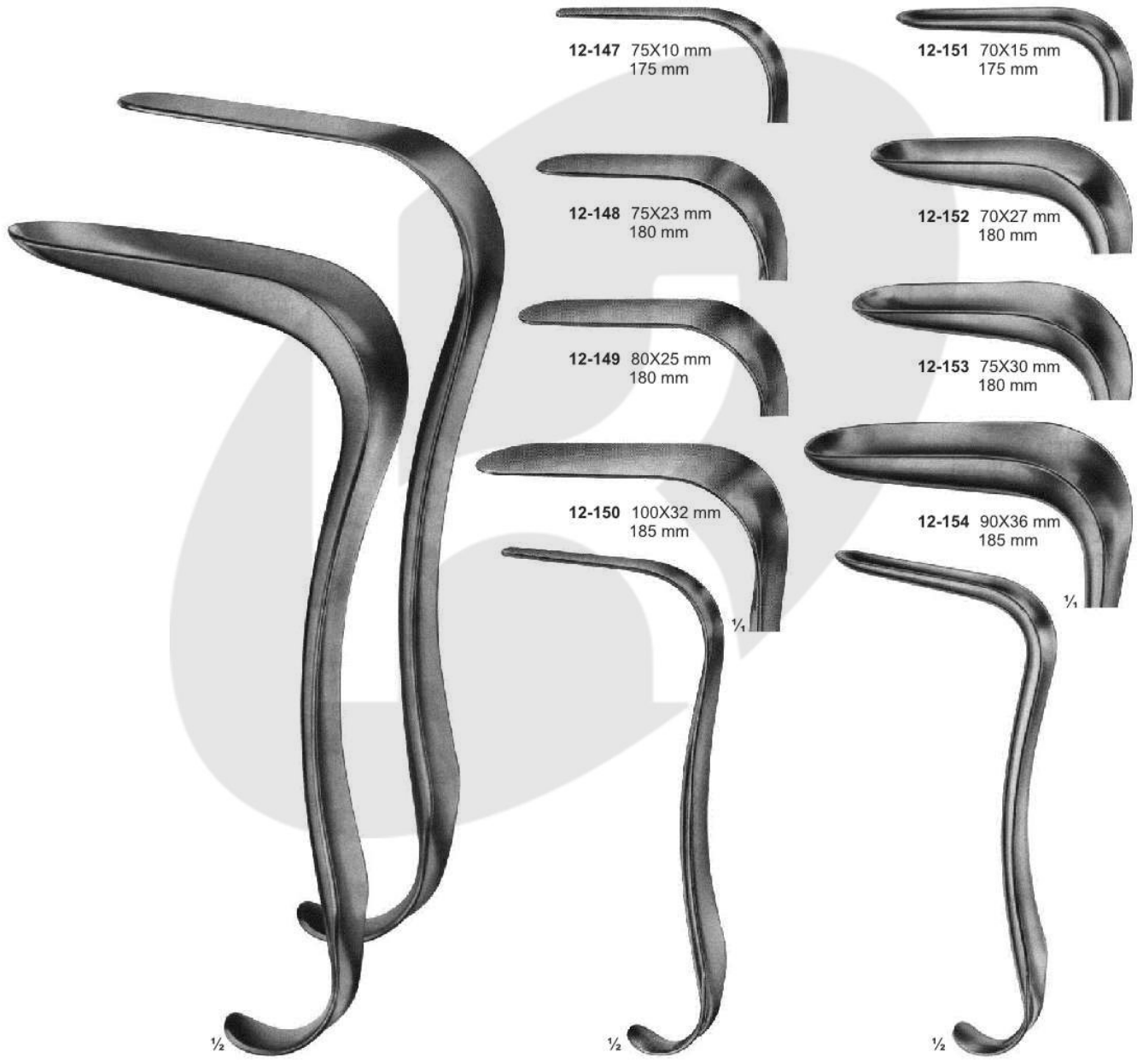

12-147 75X10 mm
175 mm

12-151 70X15 mm
175 mm

12-148 75X23 mm
180 mm

12-152 70X27 mm
180 mm

12-149 80X25 mm
180 mm

12-153 75X30 mm
180 mm

12-150 100X32 mm
185 mm

12-154 90X36 mm
185 mm

12-142 - 146
KRISTELLER
12-142 110X18 mm
12-143 110X20 mm
12-144 110X27 mm
12-145 110X30 mm
12-146 110X36 mm
220 mm

12-147 - 150
KRISTELLER
Upper blades

12-151 - 154
KRISTELLER
Lower blades

Vaginal Specula-upper and lower blades

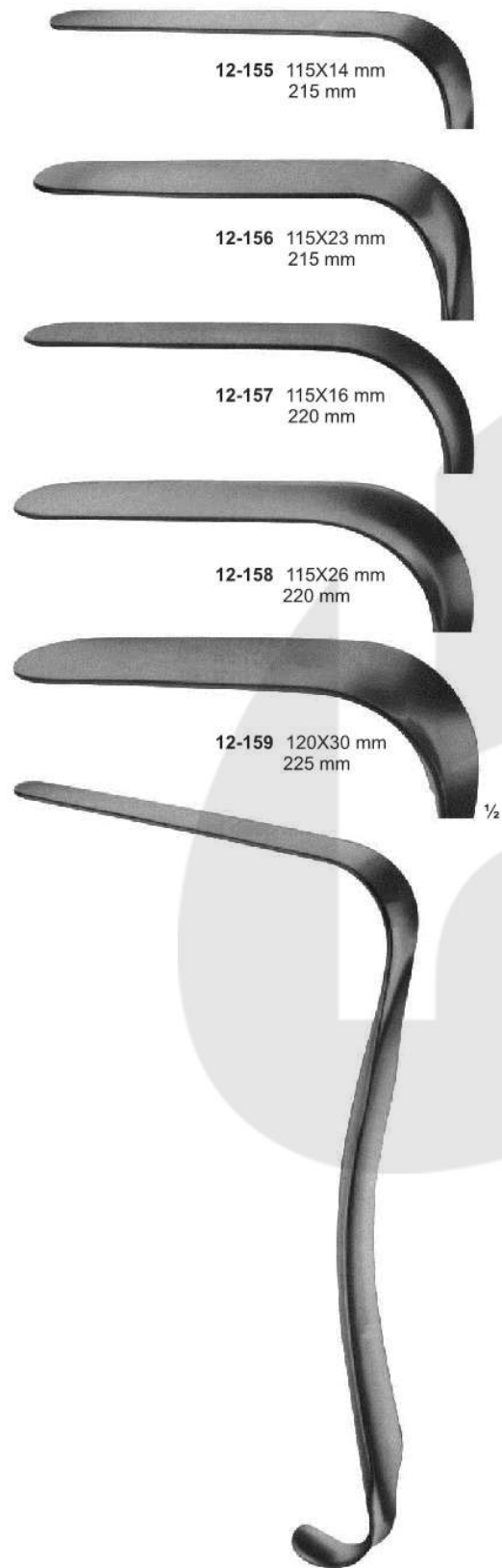

12-155 115X14 mm
215 mm

12-156 115X23 mm
215 mm

12-157 115X16 mm
220 mm

12-158 115X26 mm
220 mm

12-159 120X30 mm
225 mm

12-155 - 159
KRISTELLER
Upper blades

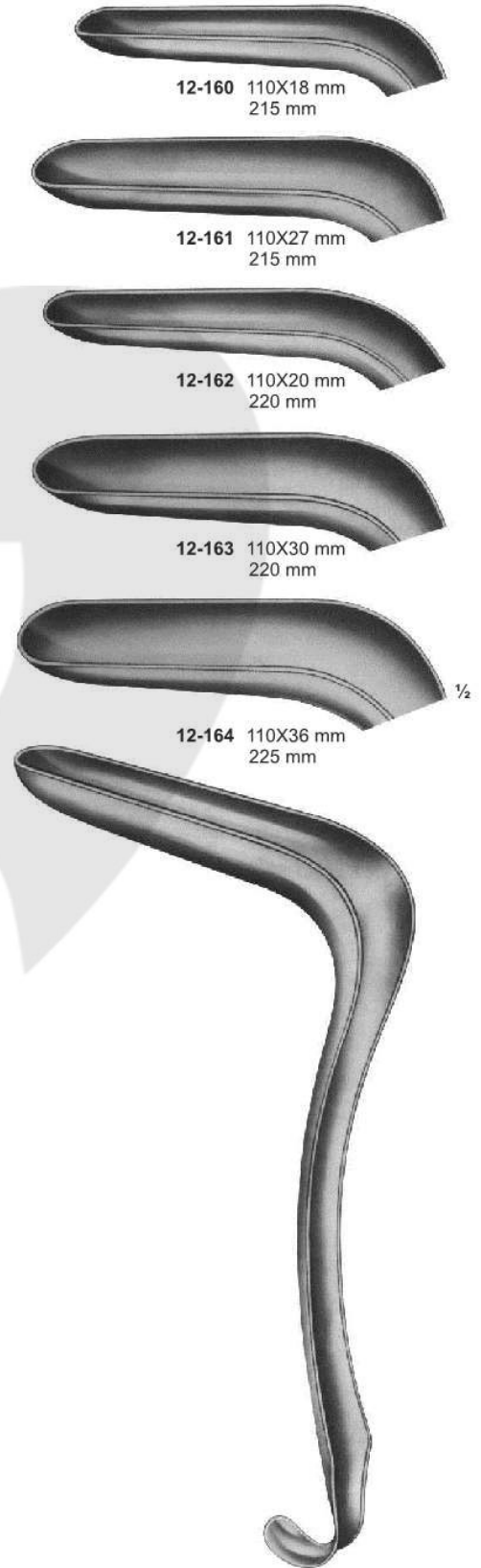

12-160 110X18 mm
215 mm

12-161 110X27 mm
215 mm

12-162 110X20 mm
220 mm

12-163 110X30 mm
220 mm

12-164 110X36 mm
225 mm

12-160 - 164
KRISTELLER
Lower blades

Vaginal Specula

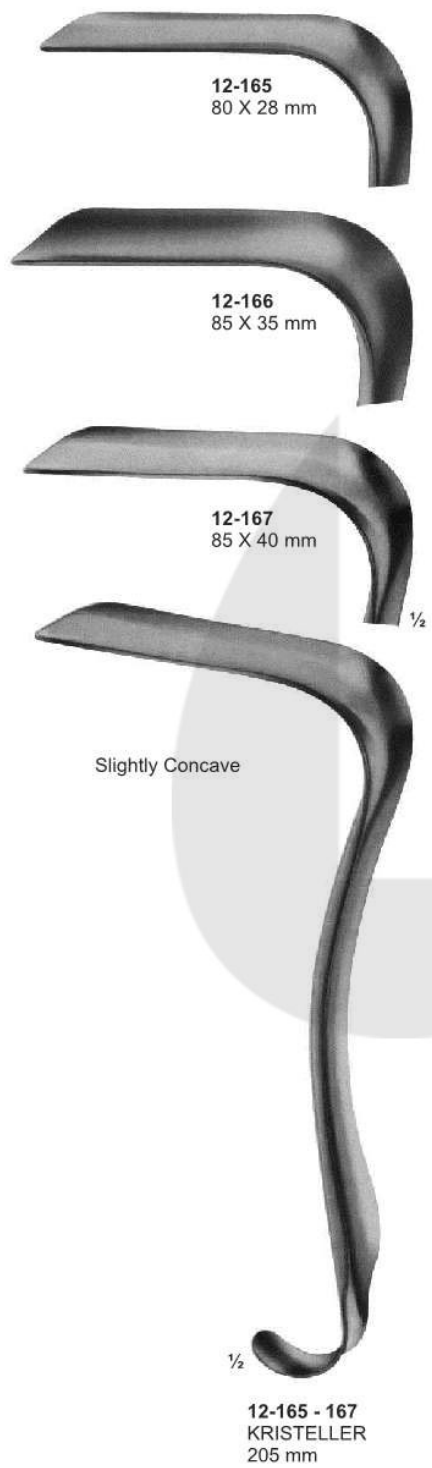

Vaginal Specula-for children & virgins / Vario Retractor

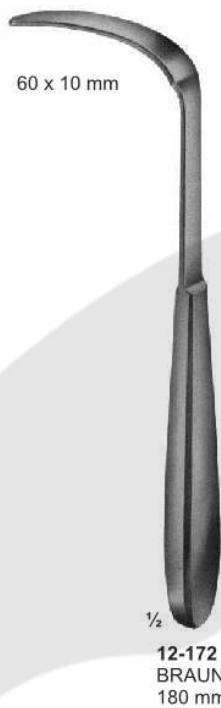

Vaginal Specula-for children and virgins



Vaginal Specula / Retractors



½

12-190 - 194
BREISKY
WIENER MODELL/
VIENNA PATTERN
12-190 100 X 20 mm
12-191 100 X 25 mm
12-192 100 X 30 mm
12-193 100 X 35 mm
12-194 100 X 40 mm
300 mm



½

12-195 - 199
BREISKY
WIENER MODELL/
VIENNA PATTERN
12-195 130 X 20 mm
12-196 130 X 25 mm
12-197 130 X 30 mm
12-198 130 X 35 mm
12-199 130 X 40 mm
320 mm



½

12-200 - 201
WEISSBARTH
12-200 80 X 28 mm
12-201 85 X 42 mm
210 mm

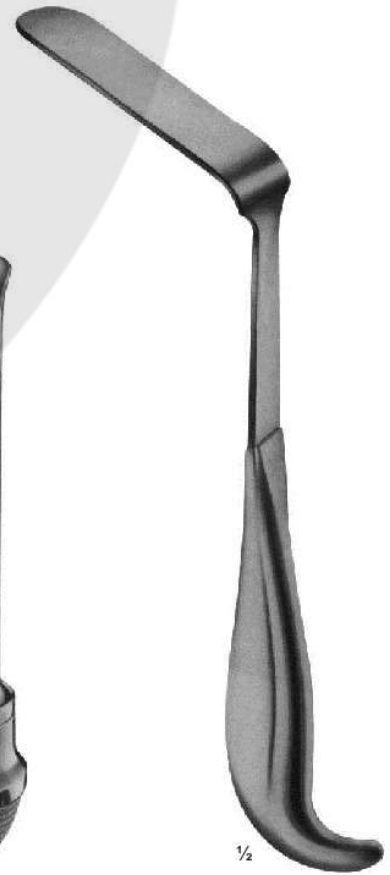

½

12-202
DOYEN
lateral speculum
80 x 30 mm
250 mm

Vaginal & Wound Retractor / Vaginal Specula



12-203
SIMON
115 X 22 mm
275 mm

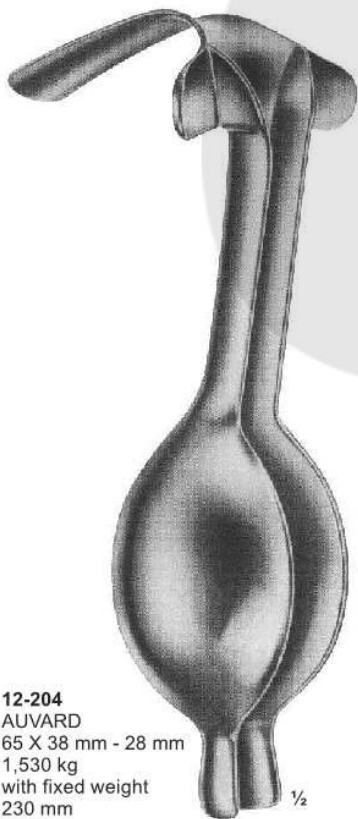

12-204
AUVARD
65 X 38 mm - 28 mm
1,530 kg
with fixed weight
230 mm



12-205 - 206
AUVARD
12-205 75 X 42 mm
(40 mm)
12-206 105 X 43 mm
(40 mm)
with detachable wight
230 mm



12-207
MARTIN
with hook shaped
handle for hanging
in weights
270 mm

Vaginal Speculas



12-210
80 X 30



12-211
85 X 35



12-212
85 X 40



12-208
55 X 40 - 60 mm



12-209
70 X 45 - 70 mm



12-208 - 212
SCHERBACK
Set consisting of:
handle
weight
5 blades

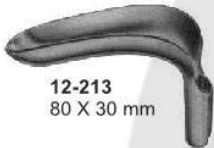

12-213
80 X 30 mm



12-217
65 X 30 mm



12-214
85 X 33 mm



12-218
75 X 35 mm

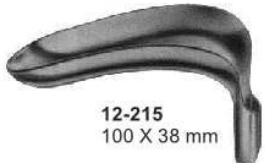

12-215
100 X 38 mm

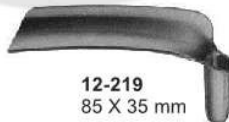

12-219
85 X 35 mm

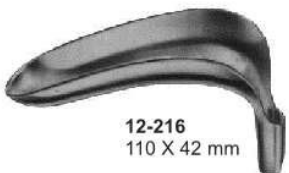

12-216
110 X 42 mm



12-220
95 X 35 mm

12-213 - 220
SCHERBACK
Set consisting of:
2 handle
8 blades

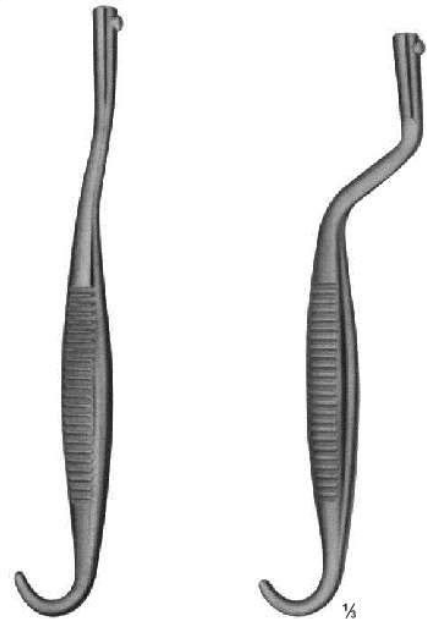

Vaginal Retractors



1/2
12-221
JOLL (FRIEDMAN)
155 mm



1/2
12-222
RICHTER
170 mm

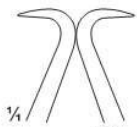

1/2
12-223
GELPI
135 mm

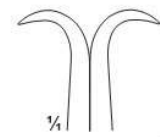

1/2
12-224
GELPI
175 mm

Uterine Dilators



½

13-101 - 143
HEGAR
with very conical point
185 mm

13-101	1	mm	13-123	23	mm
13-102	2	mm	13-124	24	mm
13-103	3	mm	13-125	25	mm
13-104	4	mm	13-126	26	mm
13-105	5	mm	13-127	1	½mm
13-106	6	mm	13-128	2	½mm
13-107	7	mm	13-129	3	½mm
13-108	8	mm	13-130	4	½mm
13-109	9	mm	13-131	5	½mm
13-110	10	mm	13-132	6	½mm
13-111	11	mm	13-133	7	½mm
13-112	12	mm	13-134	8	½mm
13-113	13	mm	13-135	9	½mm
13-114	14	mm	13-136	10	½mm
13-115	15	mm	13-137	11	½mm
13-116	16	mm	13-138	12	½mm
13-117	17	mm	13-139	13	½mm
13-118	18	mm	13-140	14	½mm
13-119	19	mm	13-141	15	½mm
13-120	20	mm	13-142	16	½mm
13-121	21	mm	13-143	17	½mm
13-122	22	mm			



½

13-144 - 152
HEGAR
205 mm

13-144	1+2	mm
13-145	3+4	mm
13-146	5+6	mm
13-147	7+8	mm
13-148	9+10	mm
13-149	11+12	mm
13-150	13+14	mm
13-151	15+16	mm
13-152	17+18	mm

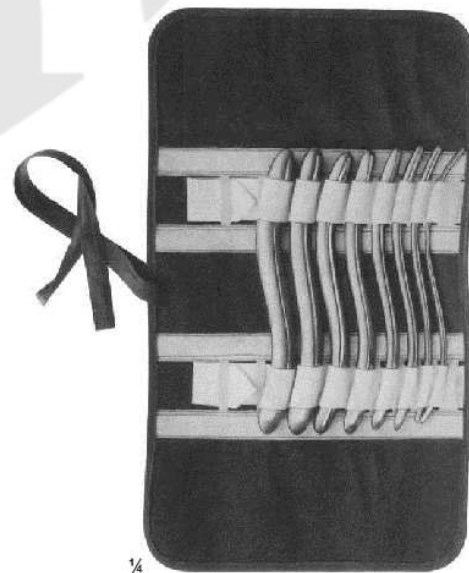

¼

13-153
HEGAR
Uterine dilator set, in canvas
roll with 8 dilators.

Uterine Dilators - Complete Sets



13-154
HEGAR
Dilator set consisting of:
14 Dilators,
1 Rack for dilators (4 - 12 mm)
1 Rack for Dilators (13 - 17 mm)
1 Metal case only,
with hinged lid, stainless 200 X 100 X 35 mm

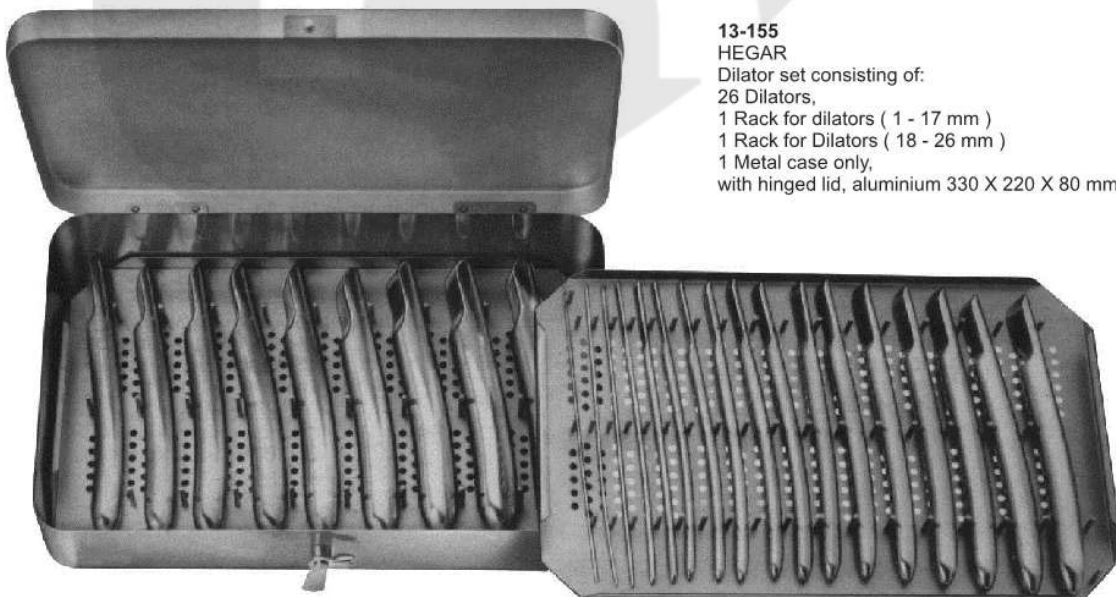

13-155
HEGAR
Dilator set consisting of:
26 Dilators,
1 Rack for dilators (1 - 17 mm)
1 Rack for Dilators (18 - 26 mm)
1 Metal case only,
with hinged lid, aluminium 330 X 220 X 80 mm

Endospecula For Cervix



13-156
KOGAN
Endospecula for cervix
and urethra, without ratchet
240 mm

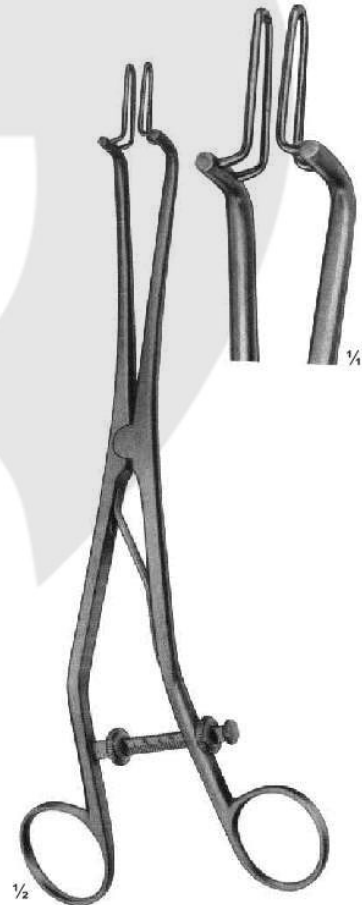

13-157
KOGAN
Endospecula for cervix
and urethra, with
scale-ratchet and fixing screws
240 mm

Uterine Probes

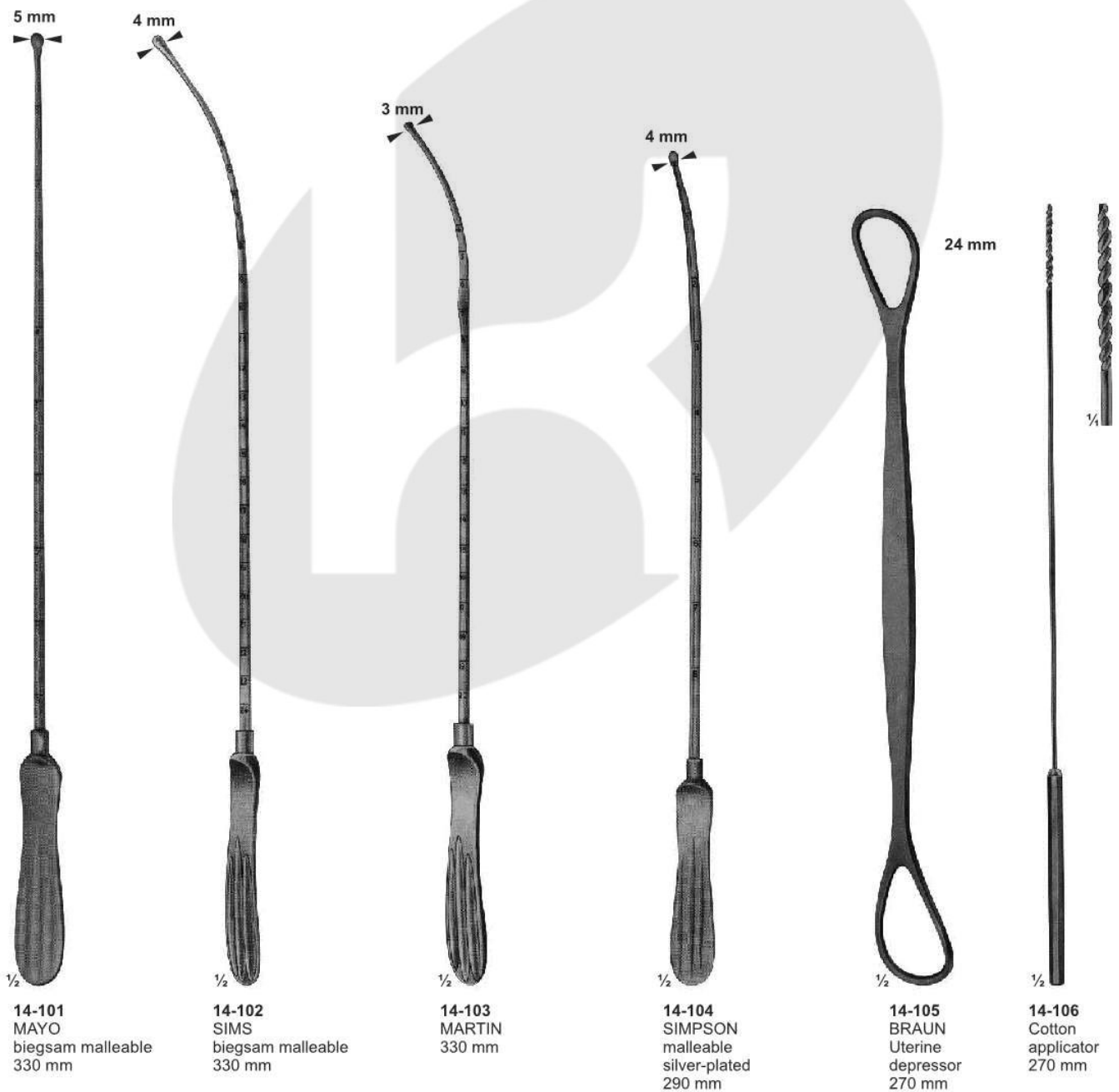

Uterine Dressing Forceps



14-107
PELKMANN
260 mm

14-108
PELKMANN
260 mm

14-109
BOZEMANN
250 mm

14-110
BOZEMANN
255 mm

Jaws with longitudinal groove

Uterine Dressing Forceps

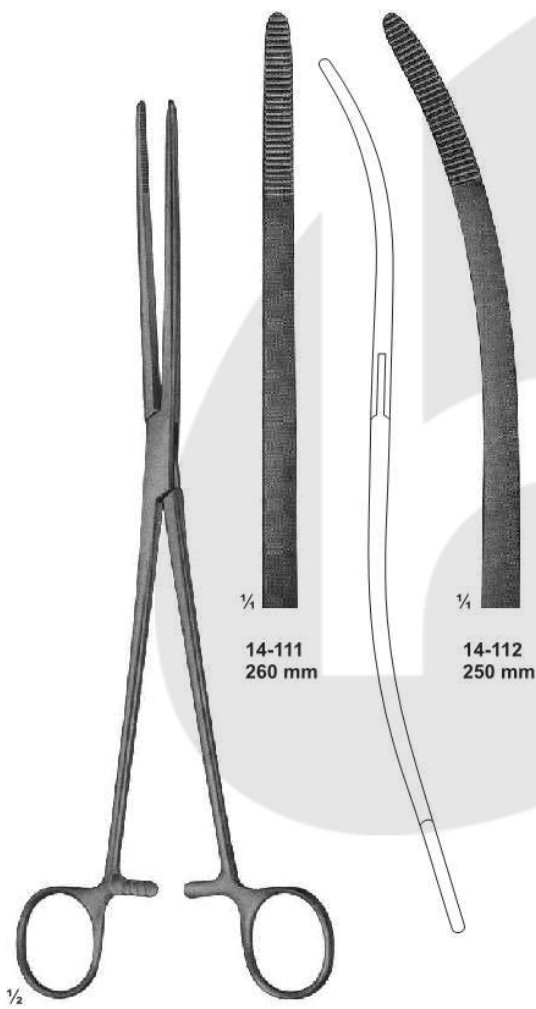

1/4
14-111
260 mm

1/4
14-112
250 mm

1/2

14-111 - 112
BOZEMANN

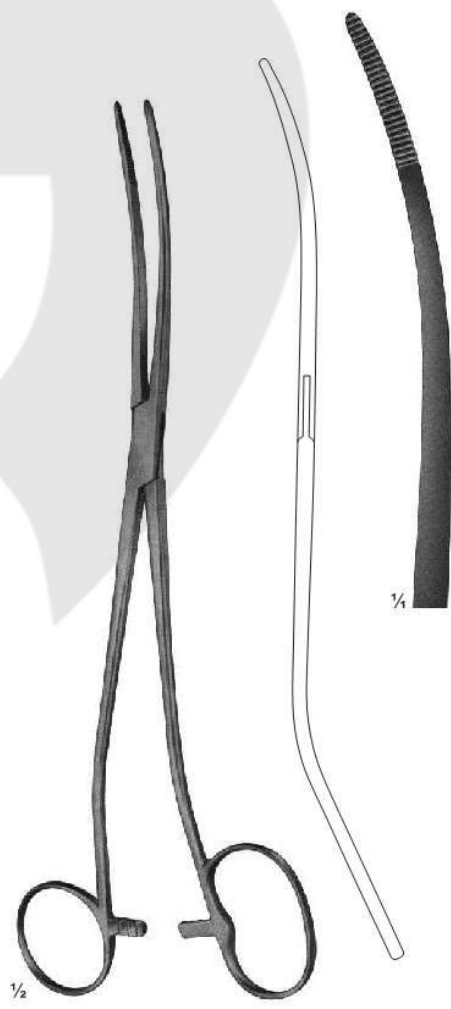

1/4

1/2

14-113
BOZEMANN-DOUGLAS
260 mm

Uterine Tenaculum Forceps

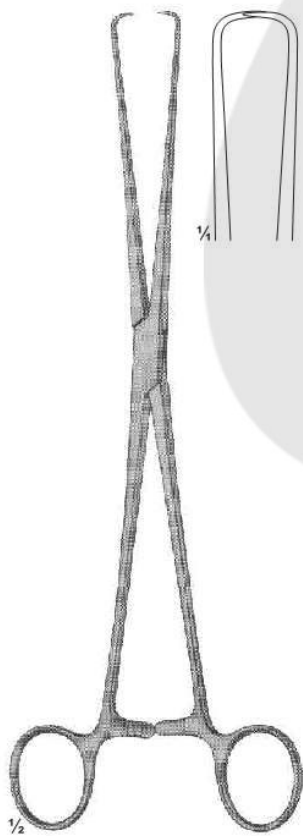

14-114
BRAUN
slender type
250 mm

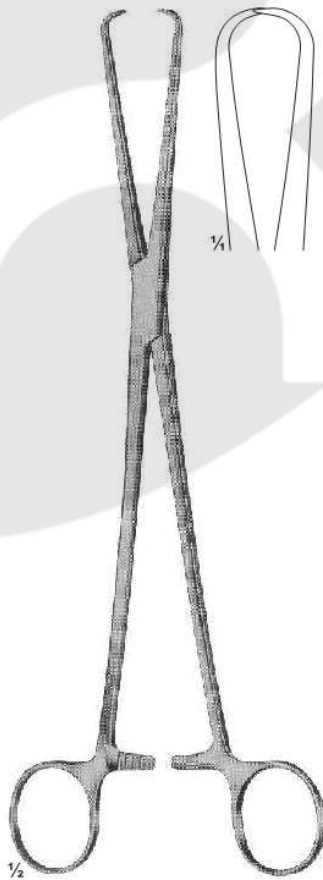

14-115
SCHRODER
250 mm

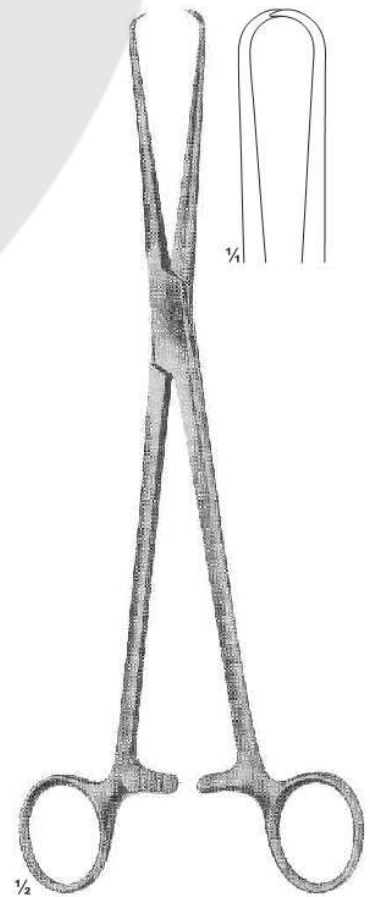

14-116
POZZI
heavy type
255 mm

Uterine Tenaculum Forceps

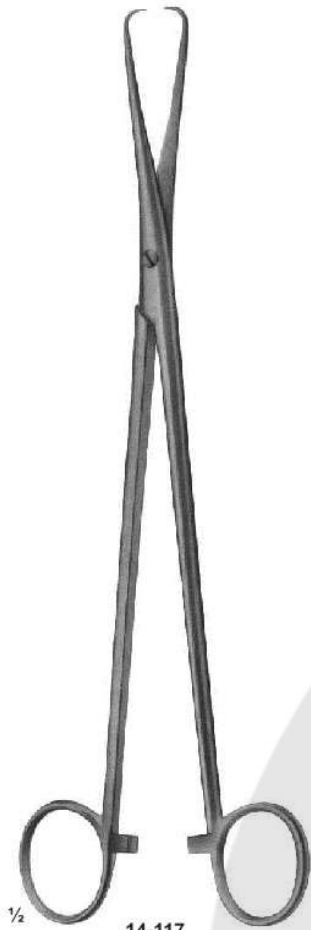

14-117
265 mm

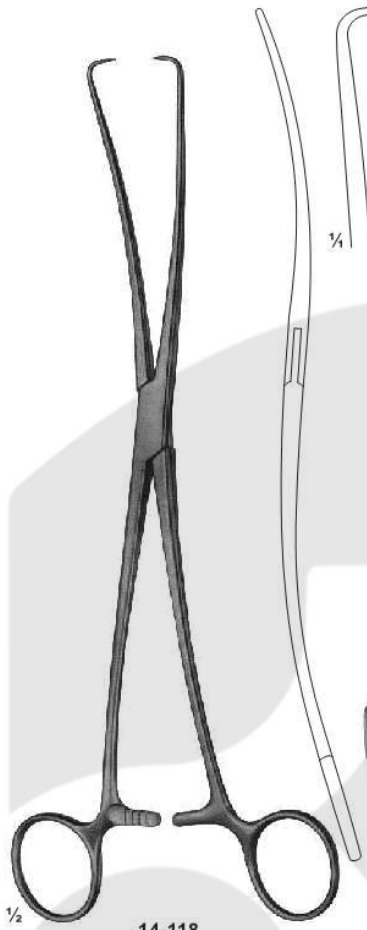

14-118
DUPLAY
250 mm

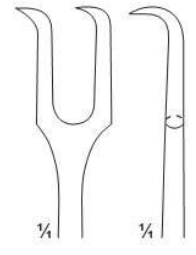

14-119
LAHEY
155 mm

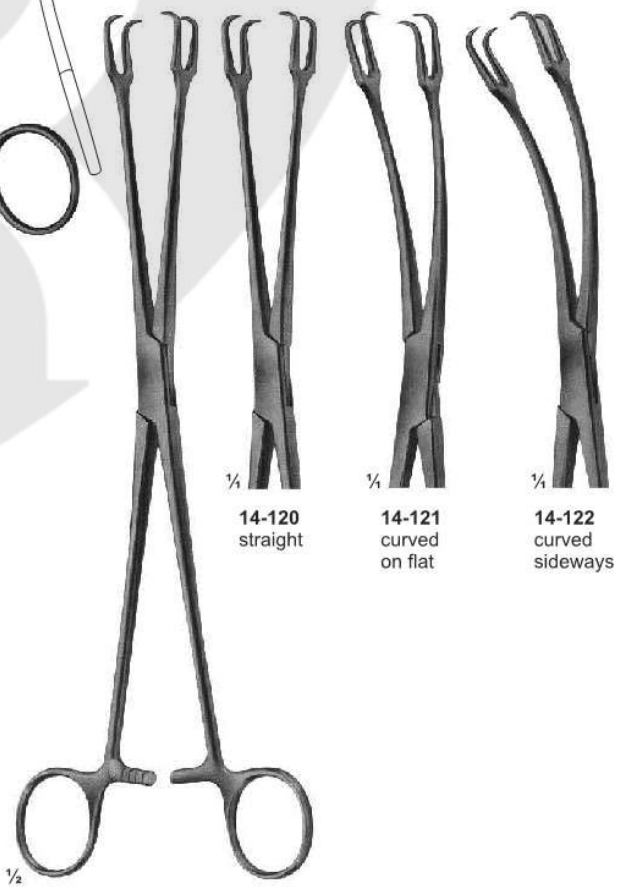
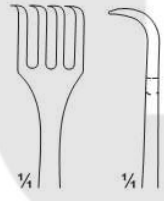

14-120
straight

14-121
curved
on flat

14-122
curved
sideways

14-120 - 122
SCHRODER
250 mm

Uterine Tenaculum Forceps

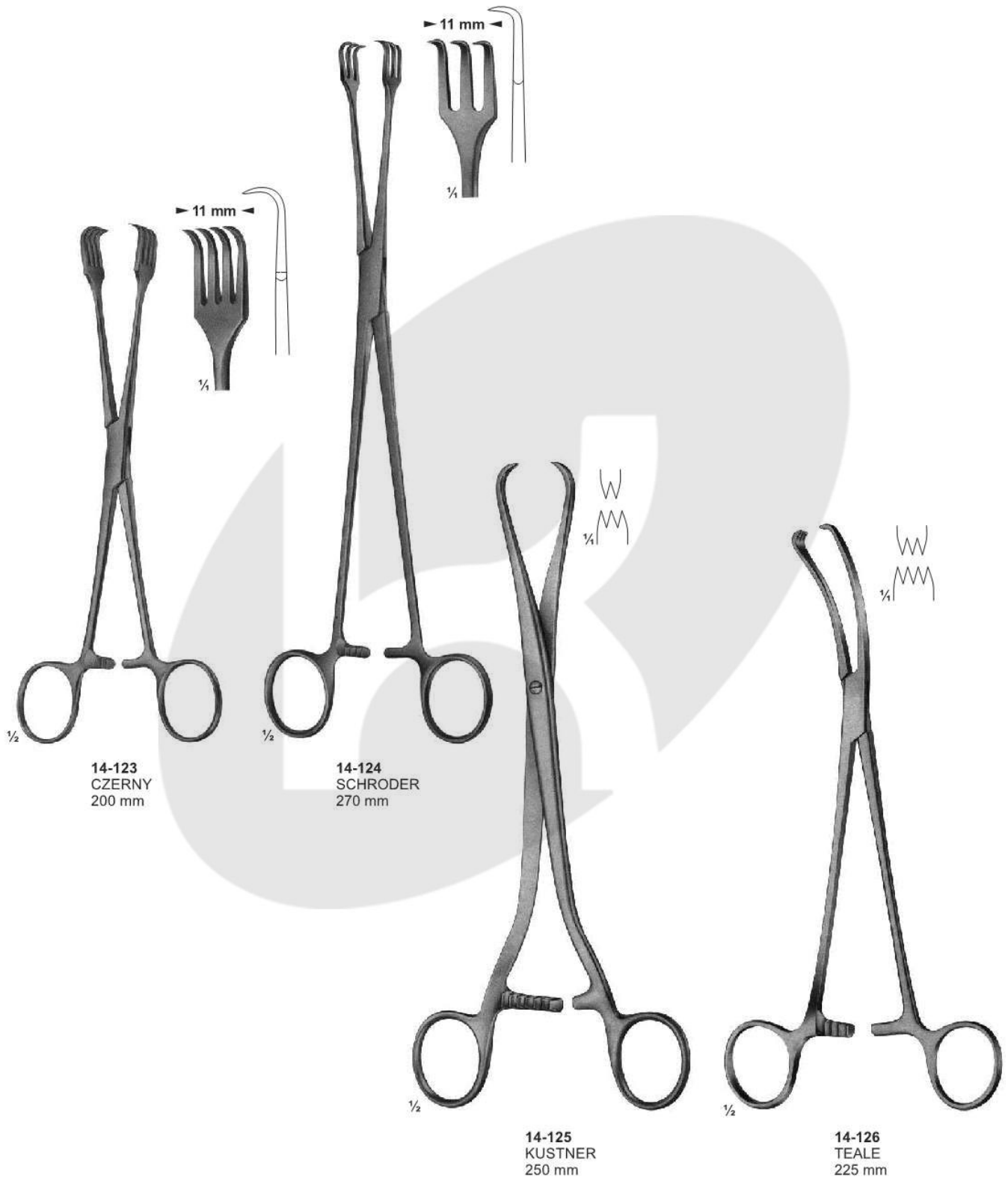

Uterine Tenaculum Forceps

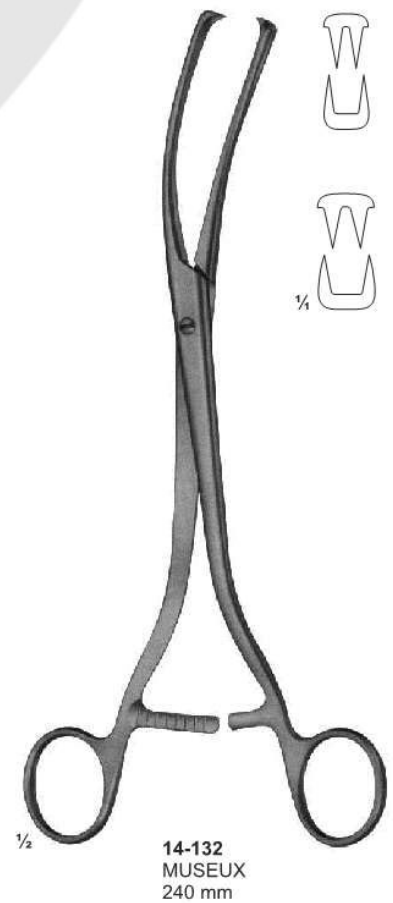
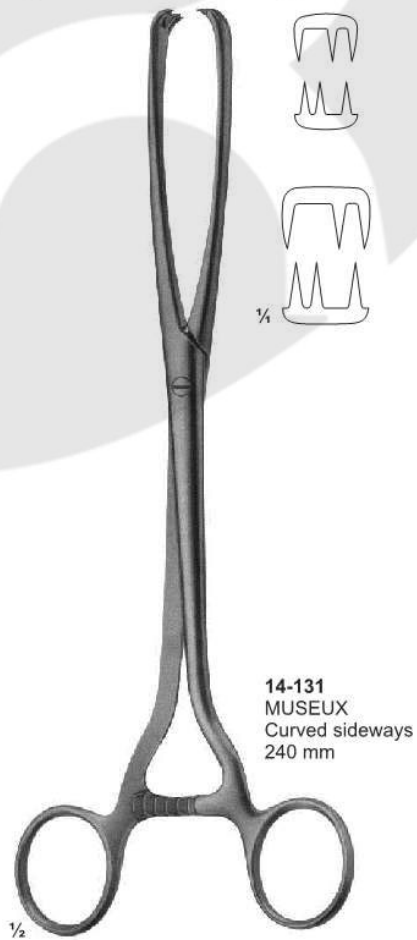
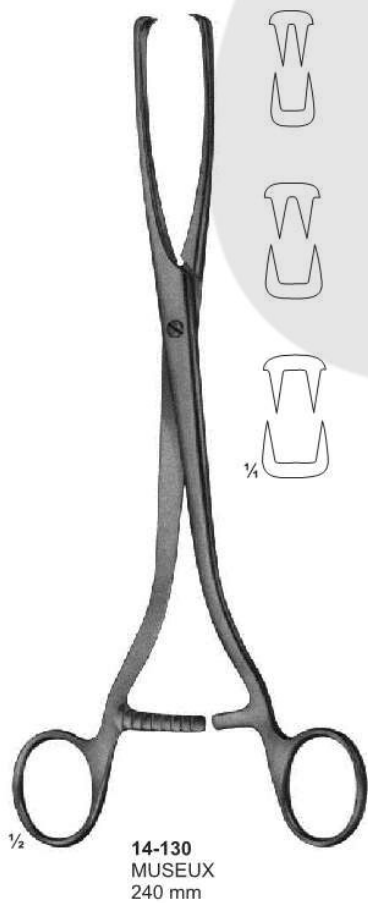

Polypus-and Ovum Forceps

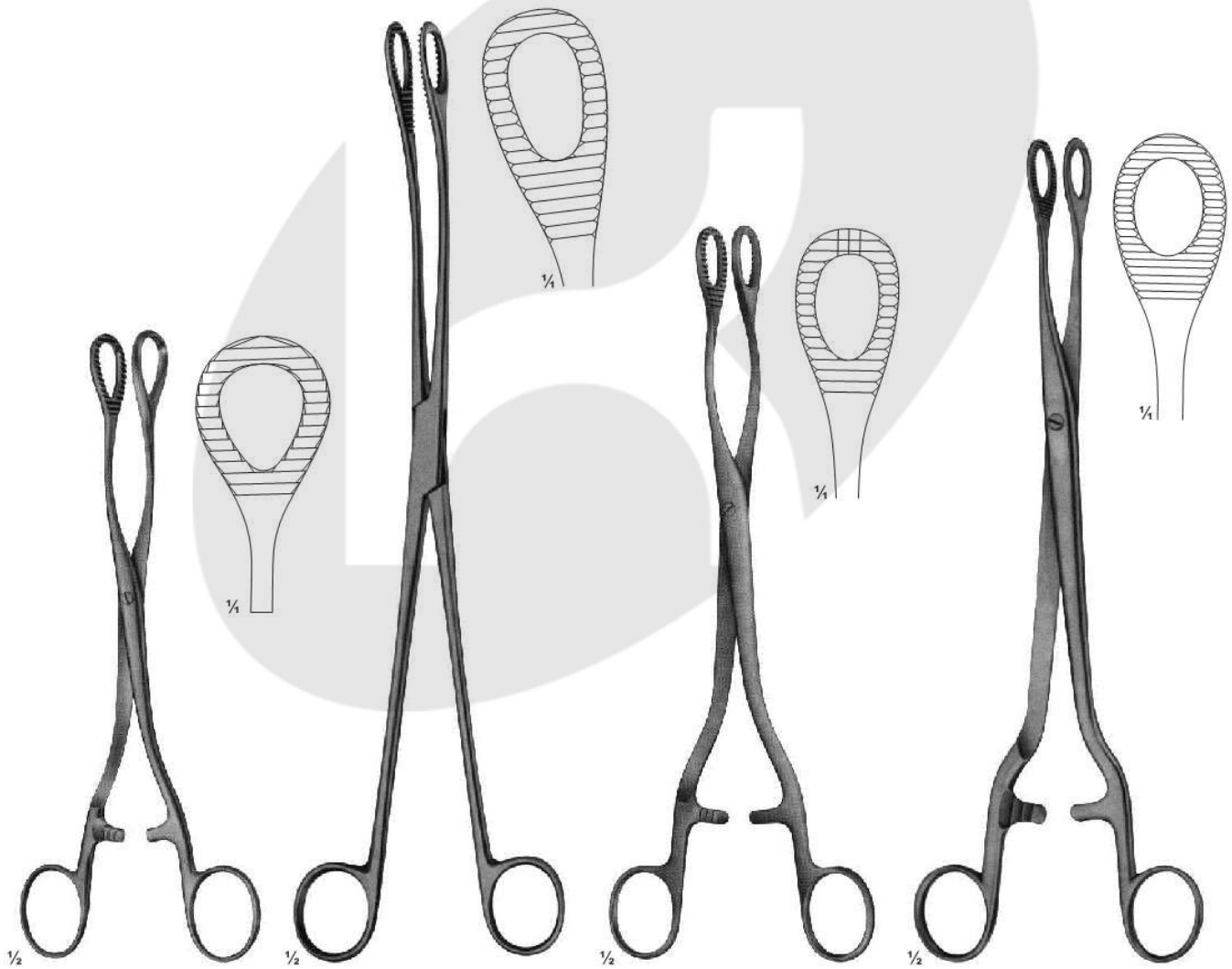

14-133
HEYWOOD-SMITH
200 mm

14-134
KELLY
320 mm

14-135
HEYWOOD-SMITH
250 mm

14-136
NOTO
280 mm

Polypus and Ovum Forceps



1/4



1/4

14-138



1/4

14-139



1/4



1/2

14-137
DOYEN
185 mm

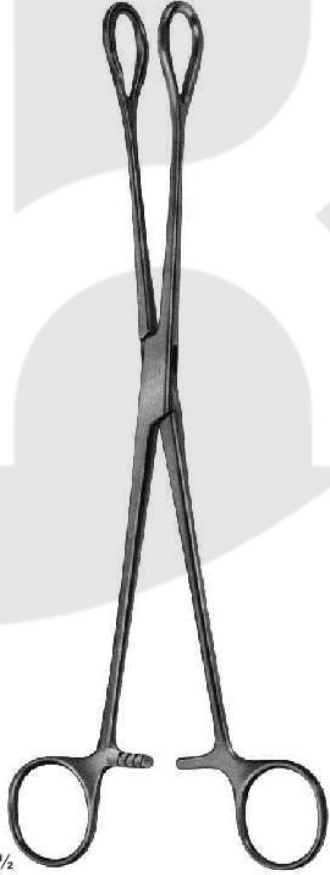

1/2

14-138 - 139
250 mm 270 mm



1/2

14-140
BUMM
280 mm

Uterine Elevating Forceps

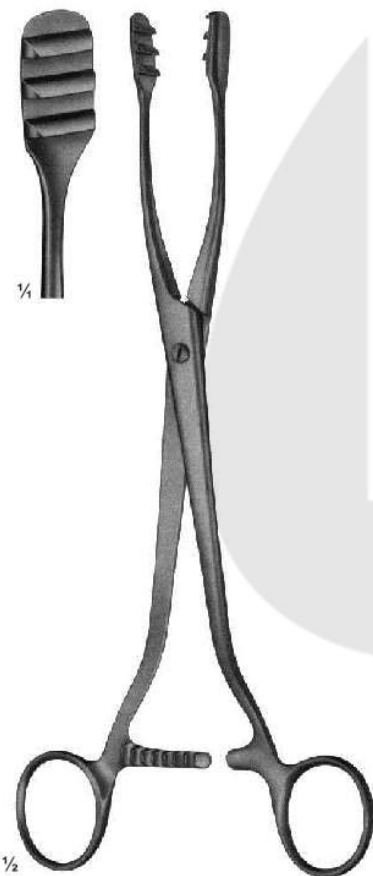

14-141
COLLIN
250 mm



14-142
COLLIN
285 mm



14-143
DARTIGUES
255 mm

Uterine Elevating Forceps



14-144
SOMMER
235 mm



14-145
STRASSMANN
260 mm

Uterine Elevating Forceps



14-146
COLLIN
265 mm

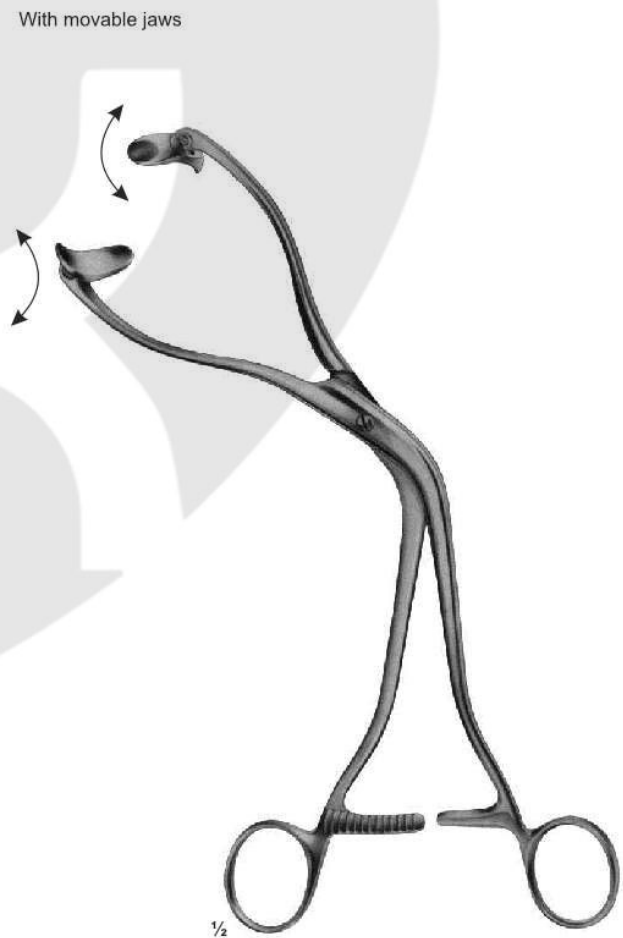

14-147
260 mm

Myoma Instruments



14-148
SEGOND
Myomatome
270 mm

1/2



14-149
DOYEN
Myoma screw
150 mm

1/2



14-150
DOYEN
Myoma screw
190 mm

1/2

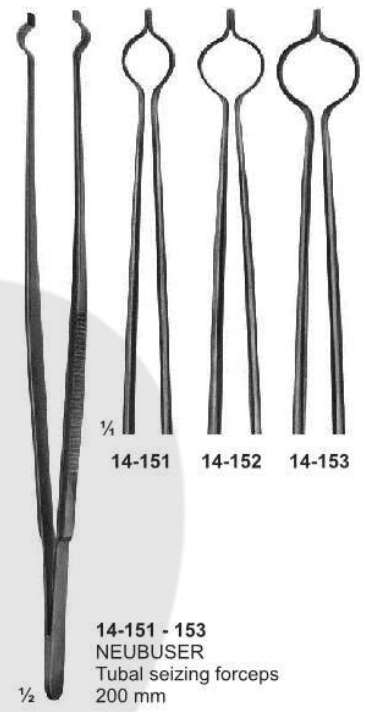

1/4
14-151 **14-152** **14-153**

14-151 - 153
NEUBUSER
Tubal seizing forceps
200 mm



14-154
Splint guide
with thread

1/4



14-155
Splint guide
with round
handle
180 mm

1/2

1/4



14-156
Angled glass rods
Set . 3 pieces

1/2

1/4



145 X 100 X 1.5 mm

14-157
Silicon operating pad
pre-cut

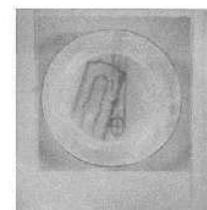

14-158
Polyethylene splint material
soft-sterile
0.45 mm

Biopsy Curettes

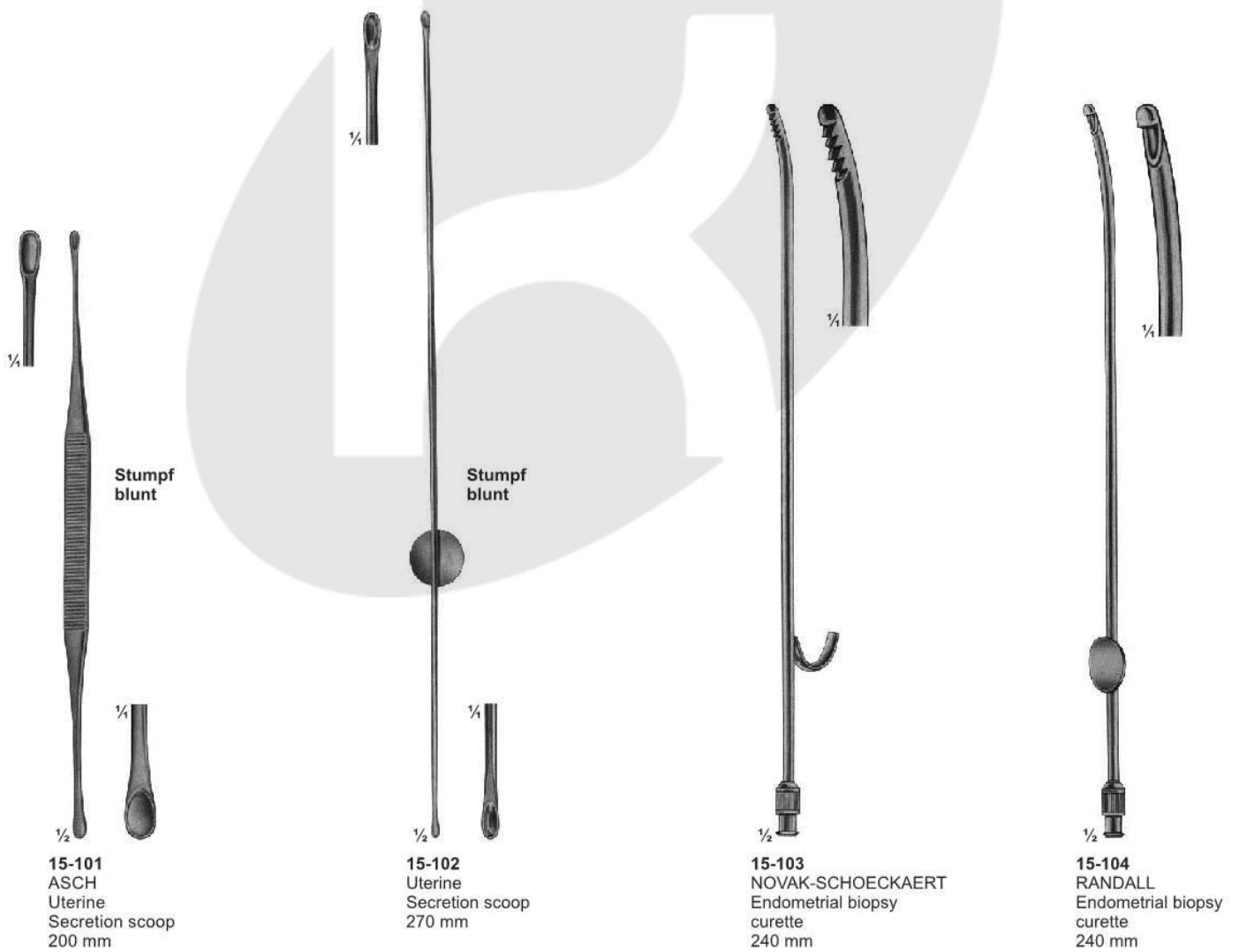

Biopsy Forceps

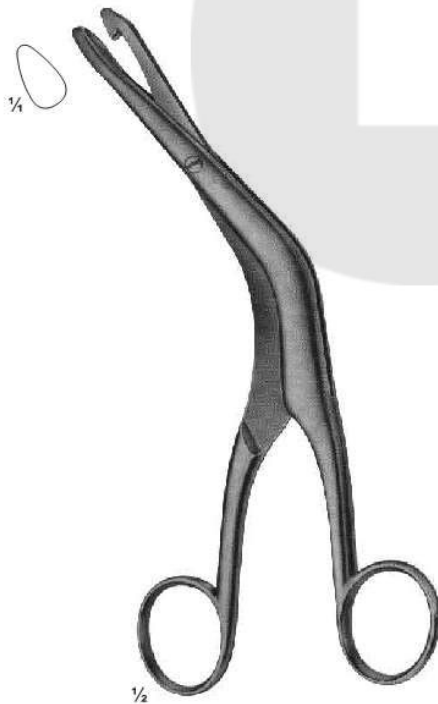
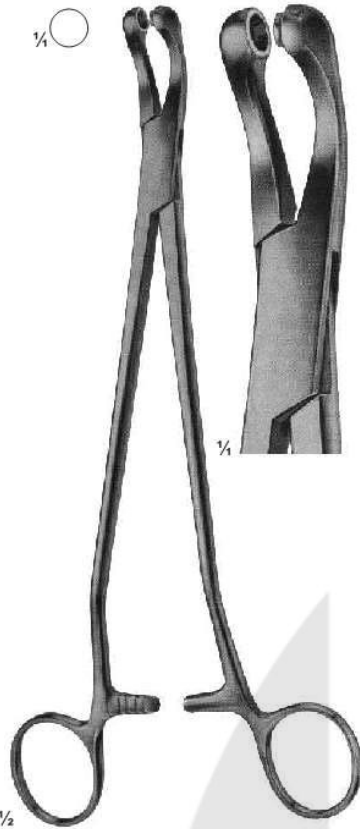

Biopsy Forceps

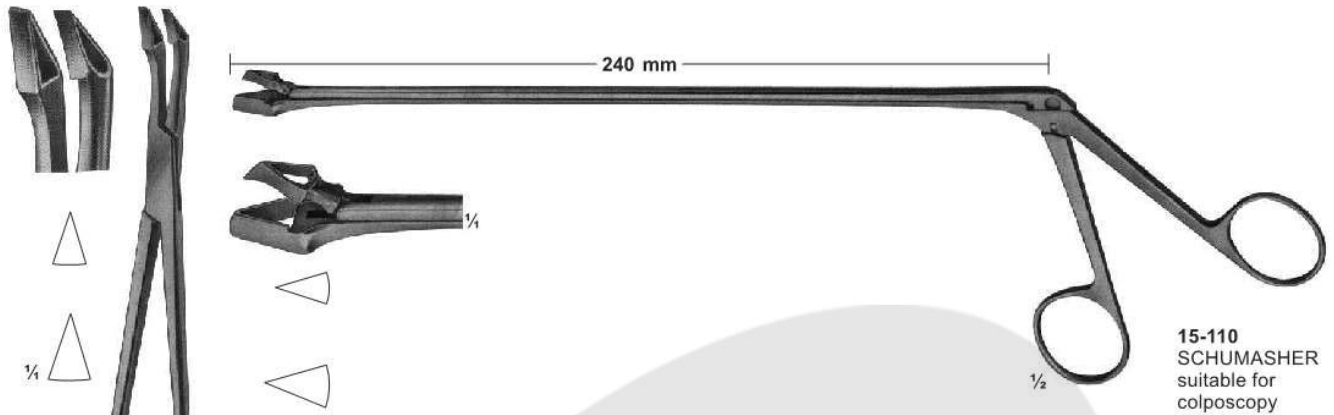

15-110
SCHUMASHER
suitable for
colposcopy

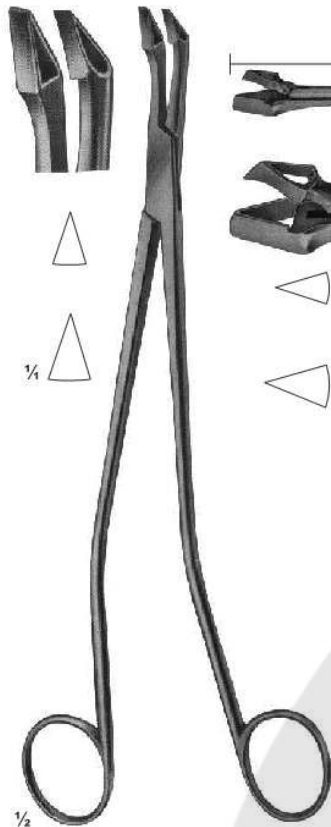

15-109
SCHUMASHER
240mm

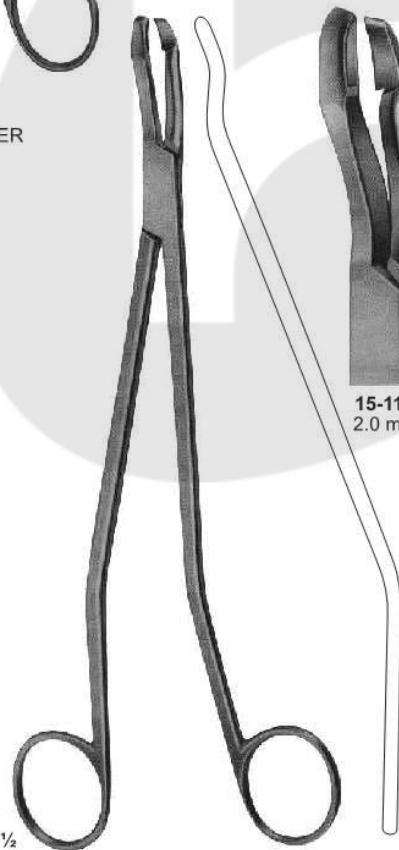

15-111 - 113
SEIDL DBP
Biopsy forceps, bayonet shaped
for portio, vagina and vulva
240mm



15-111
2.0 mm



15-112
2.4 mm



15-113
2.4 mm

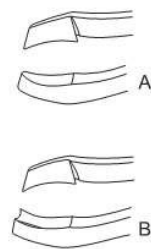

Biopsy Forceps

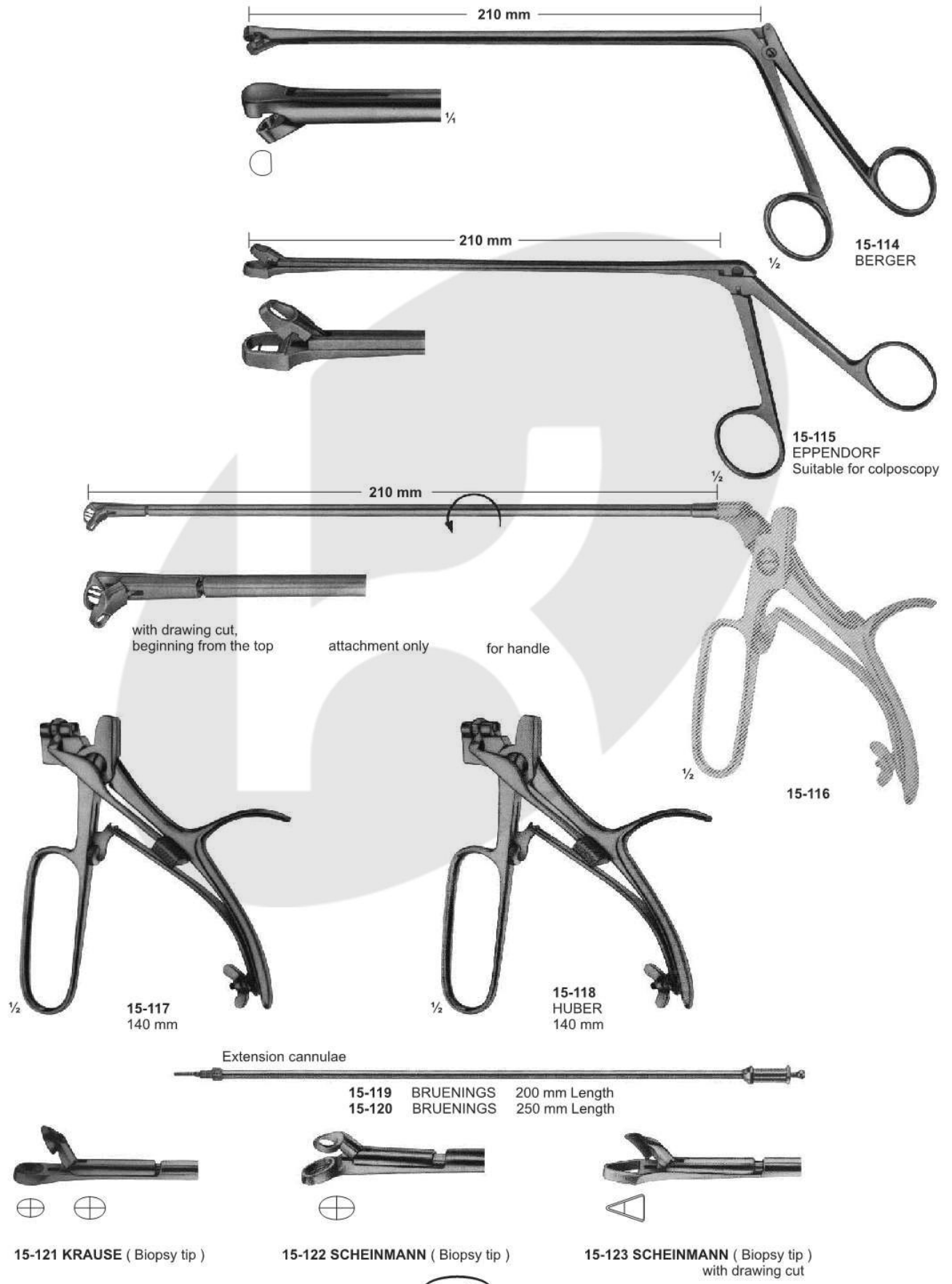

Uterine Scoops

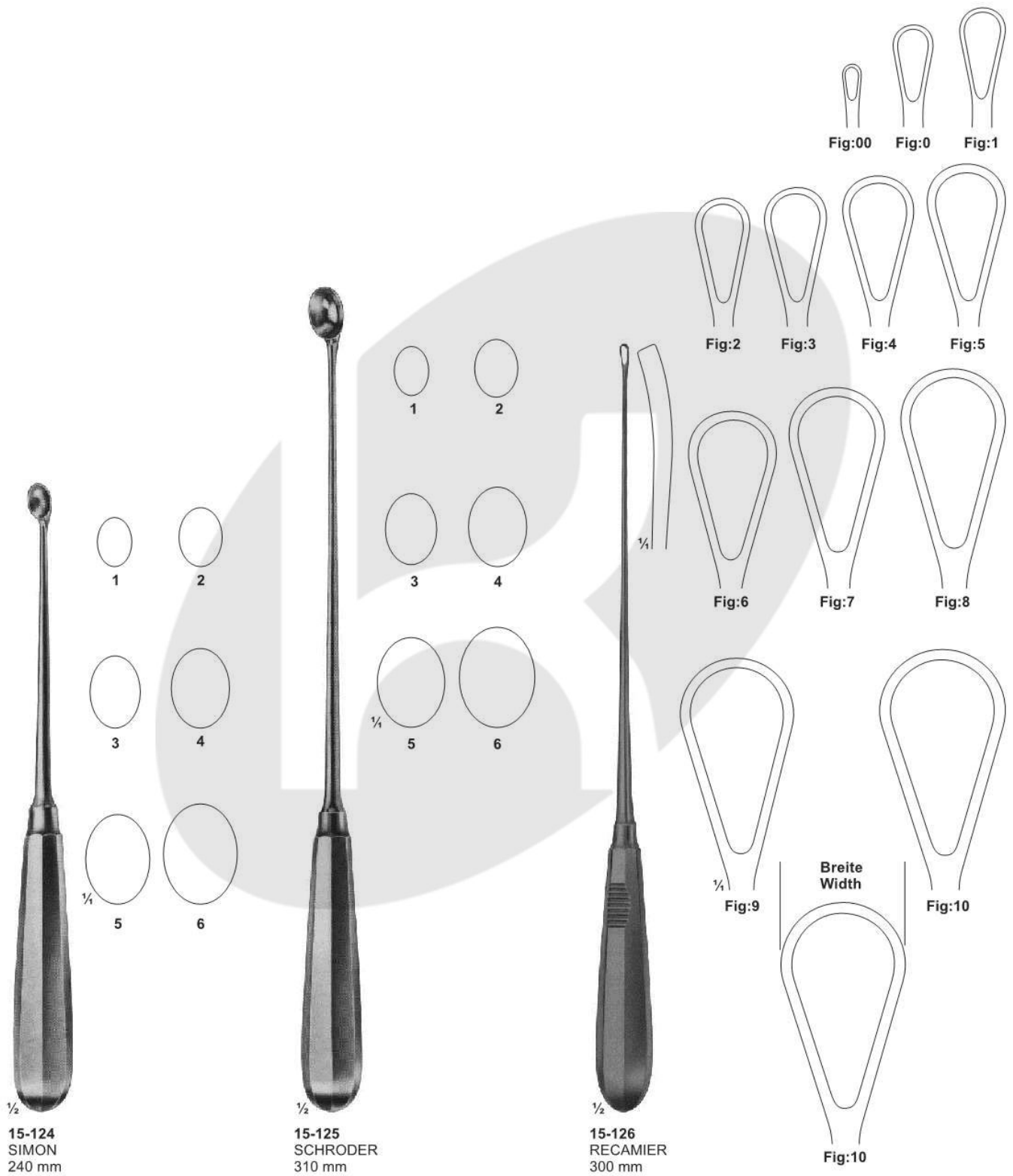

Uterine Curettes

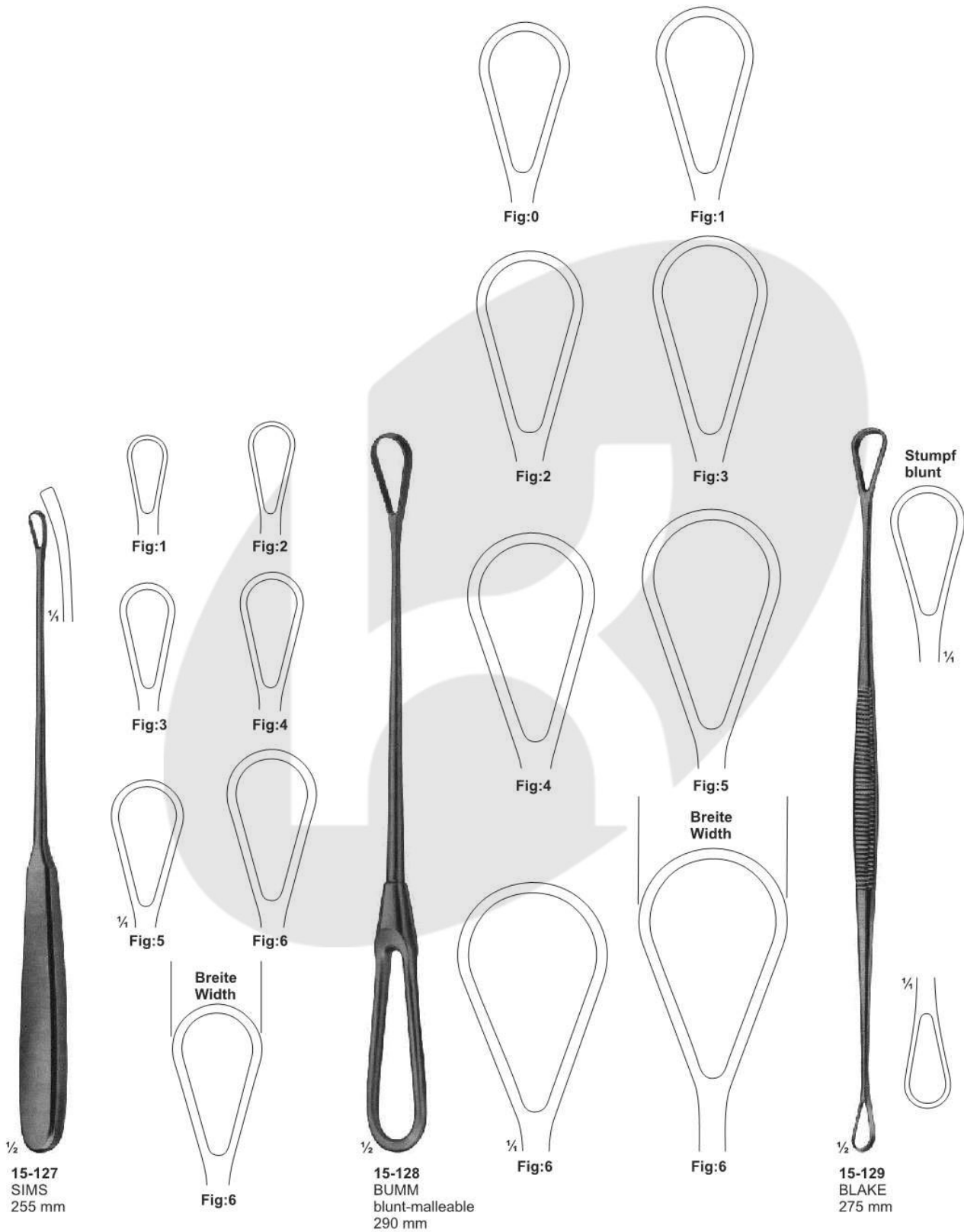

Placenta-and Ovum Currettes



15-130
COLLIN
300 mm



15-131
RECAMIER
blunt-rigid
360 mm

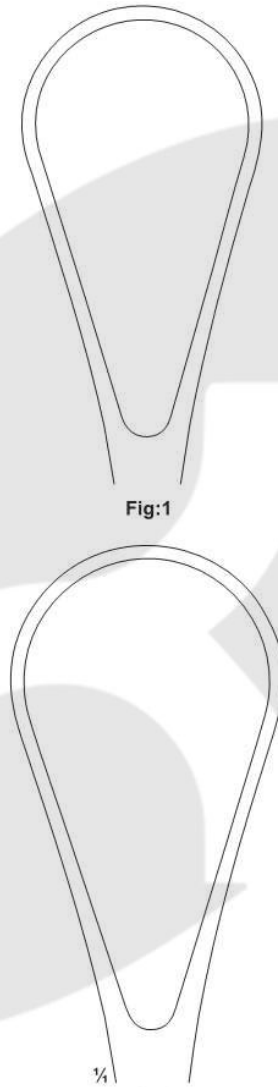

Fig:1

Fig:2



15-132
BUMM
310 mm

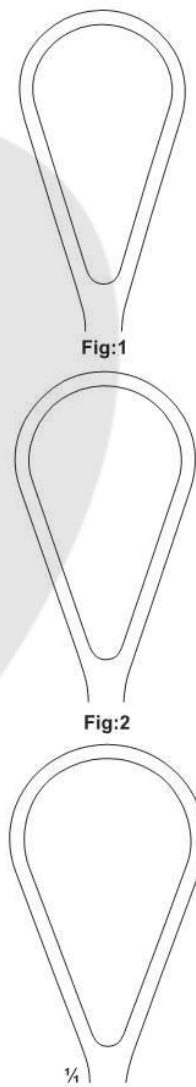

Fig:1

Fig:2

Fig:3

Vacuum Curettes

15-133 - 138

Suction curettes, stainless steel, fitting hose connection.

Working tips are smoothly rounded of, therefore no danger of perforation.



(suitable for suction biopsy)

15-133: diam 4 mm

15-134: diam 6 mm

15-135: diam 8 mm

15-136: diam 10 mm

15-137: diam 12 mm

15-138: diam 14 mm

15-139

Hose connection inside diam. 11 mm curved stainless steel.

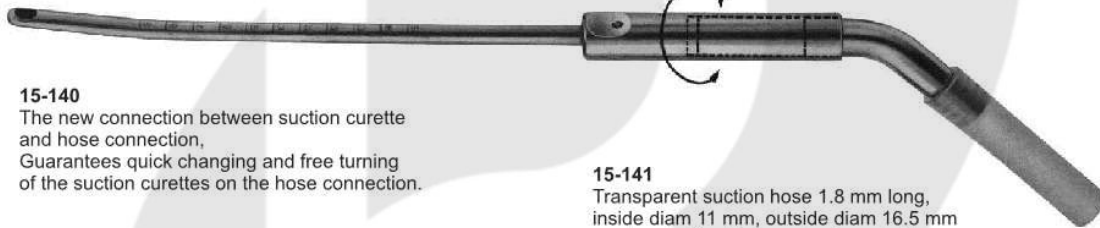

15-140

The new connection between suction curette and hose connection, Guarantees quick changing and free turning of the suction curettes on the hose connection.

15-141

Transparent suction hose 1.8 m long, inside diam 11 mm, outside diam 16.5 mm can be sterilized in an autoclave at 1 bar overpressure (120 C)

15-142

Strainer for tissues, plastic, for single use only, to be used for histopathological examination.

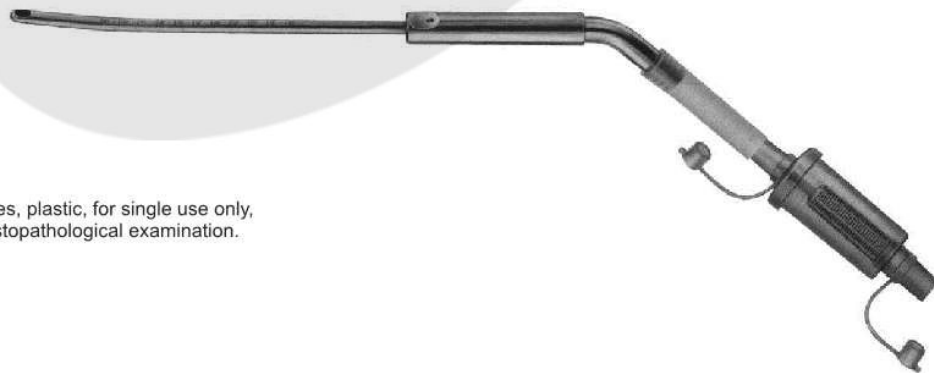

Gynaecological Instruments



15-143 diam 8 mm
15-144 diam 10 mm
BOZEMANN-FRITSCH
Uterine Flushing Tube
350 mm

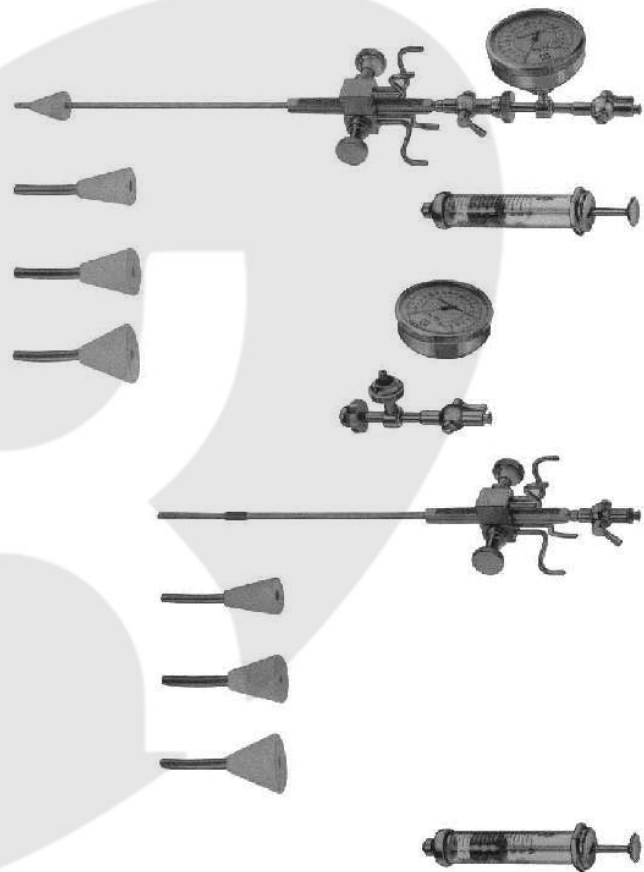

15-145
SCHULZE
Salpingograph, for utero-salpingography
in wooden case, consisting of:
Manometer, Connection, Uterine canulla
with tap, Cone S.M.L,
Record Syringe 10 cc, Luer lock mount.



15-146
SCHULZE
Salpingograph, equipment
without manometer.

Obstetrics-Pelvimeters

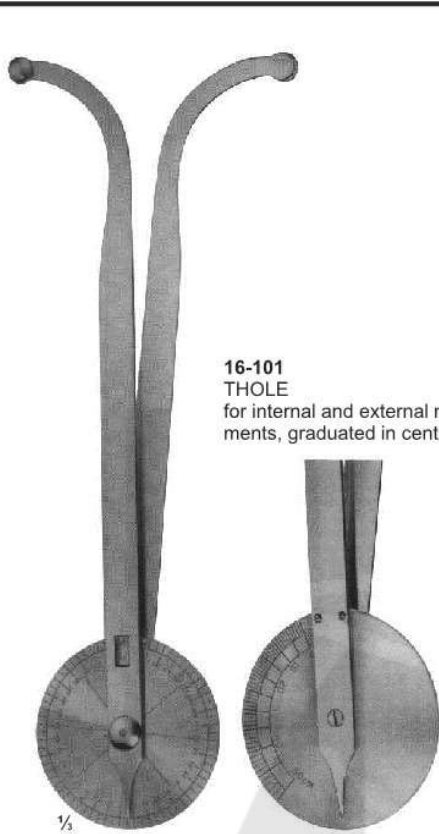

16-101
THOLE
for internal and external measurements, graduated in centimeters

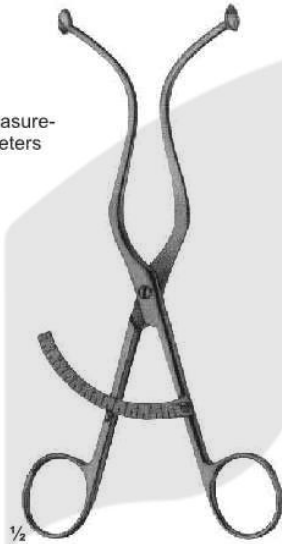

16-102
DE LEE
graduated in centimeters and inches



16-103
COLLIN
graduated in centimeters

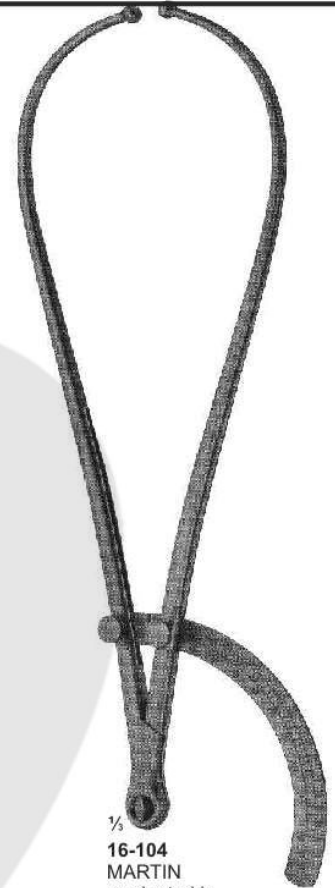

16-104
MARTIN
graduated in centimeters

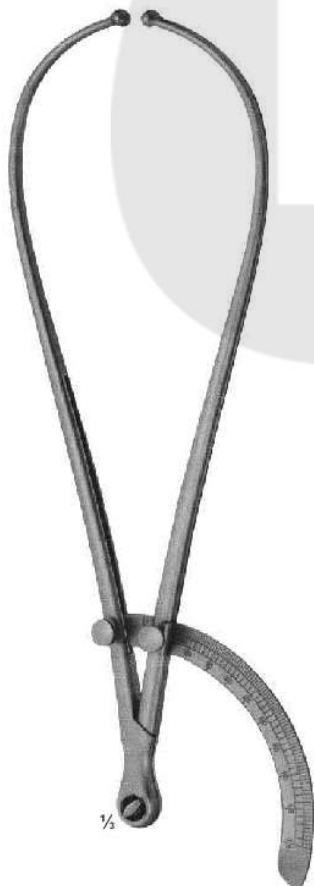

for internal measurements between symphysis and promontory

16-105
COLLIN
graduated in centimeters

The additional straight arm can be replaced. The pelvimeter with straight arm is used for localisation of the portio vaginalis uteri and of vaginal metastasis.

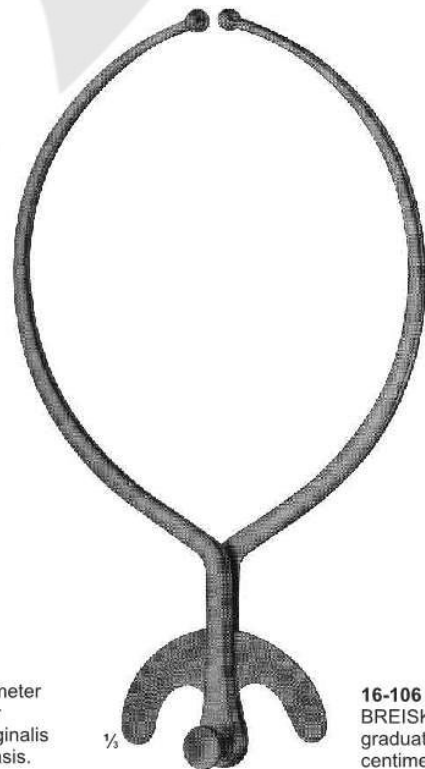

16-106
BREISKY
graduated in centimeters

Obstetrics-Pelvimeters

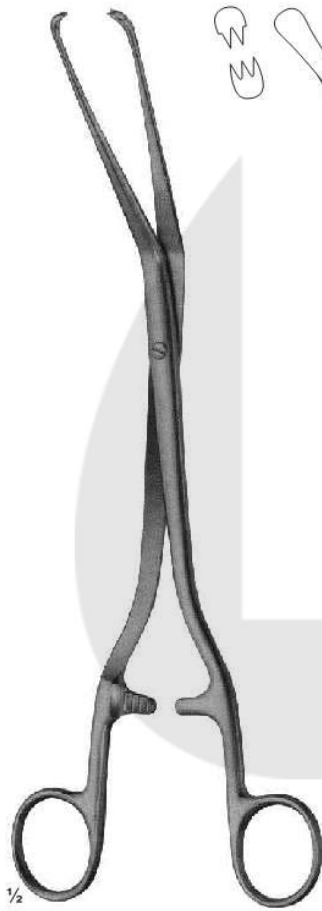

16-107
HERFF
puncturing forceps
225 mm



16-108
IOWA
puncturing forceps
260 mm

Scissors of Obstetrics, Umbilical cord clamp



16-109
SCHUMACHER
Umbilical cord
scissors
155 mm



16-110
Umbilical cord
scissors
105 mm

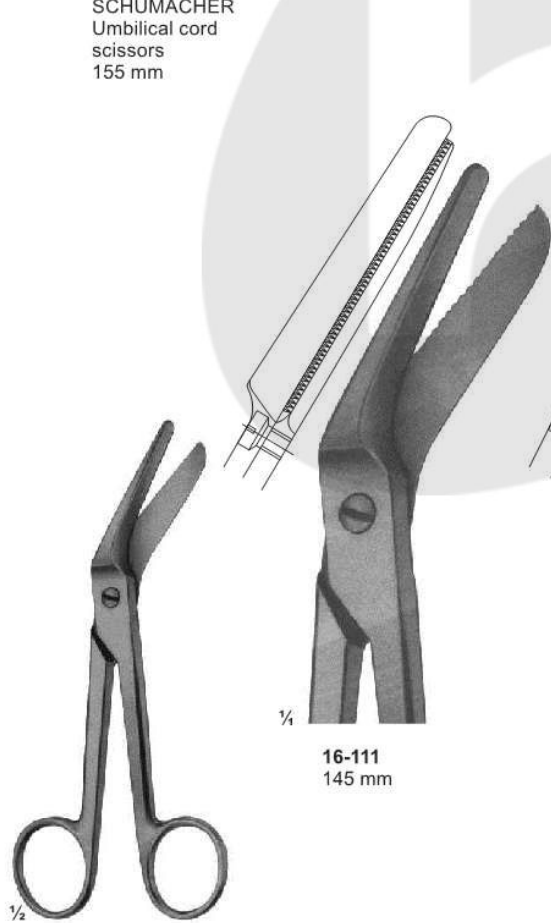

16-111
145 mm

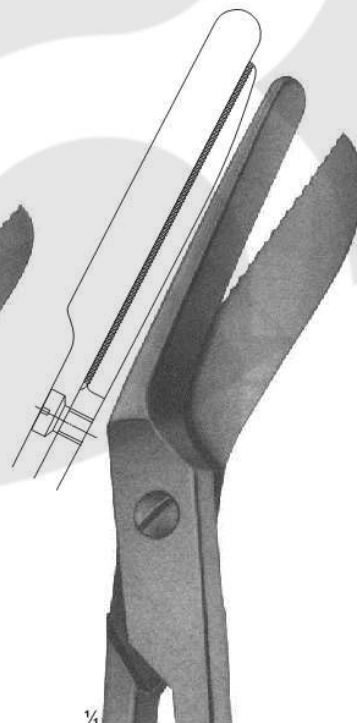

16-112
200 mm

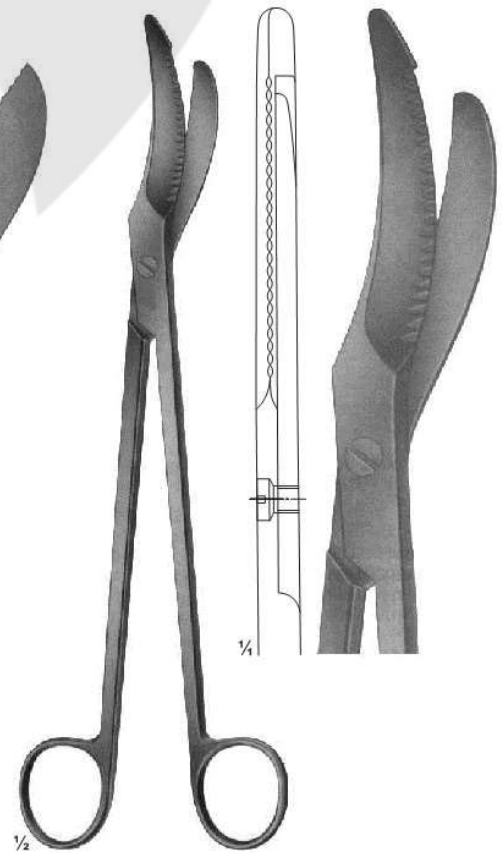

16-113
Episiotomy Scissors
240 mm

Obstetrics Forceps

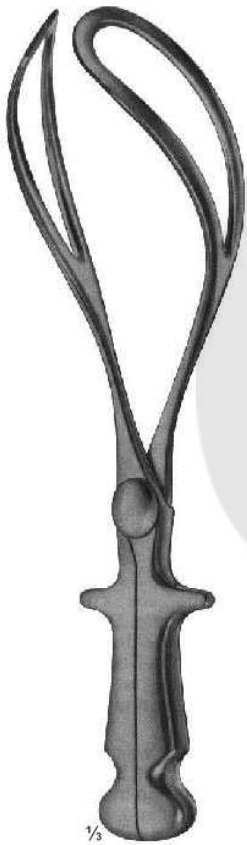

1/3
16-114
355 mm

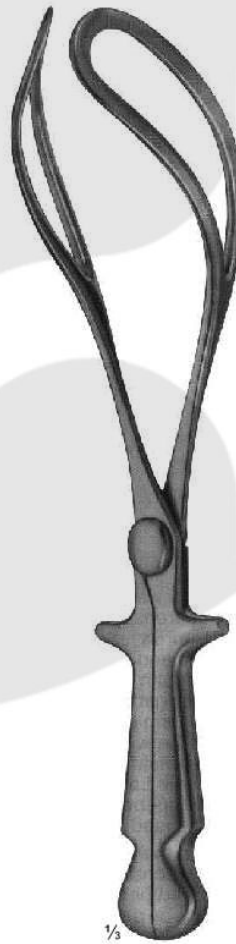

1/3
16-115
400 mm



1/3
16-116
SIMPSON-BRAUN
305mm

Obstetrics Forceps



16-117
SIMPSON-BRAUN
305mm



16-118
SIMPSON
235mm



16-119
WRIGLEY
250 mm

Obstetrics Forceps



16-120
GREEN-ARMYTAGE
Caesarean section haemostatic
forceps, for edges of the transverse
incision in the lower segment
220 mm

16-121
WILLETT
Scalpel Flap forceps
185 mm

16-122
GAUSS
Scalpel Flap forceps
260 mm

Obstetrics-Placenta and Ovum Forceps



Obstetrics-Placenta and Ovum Forceps

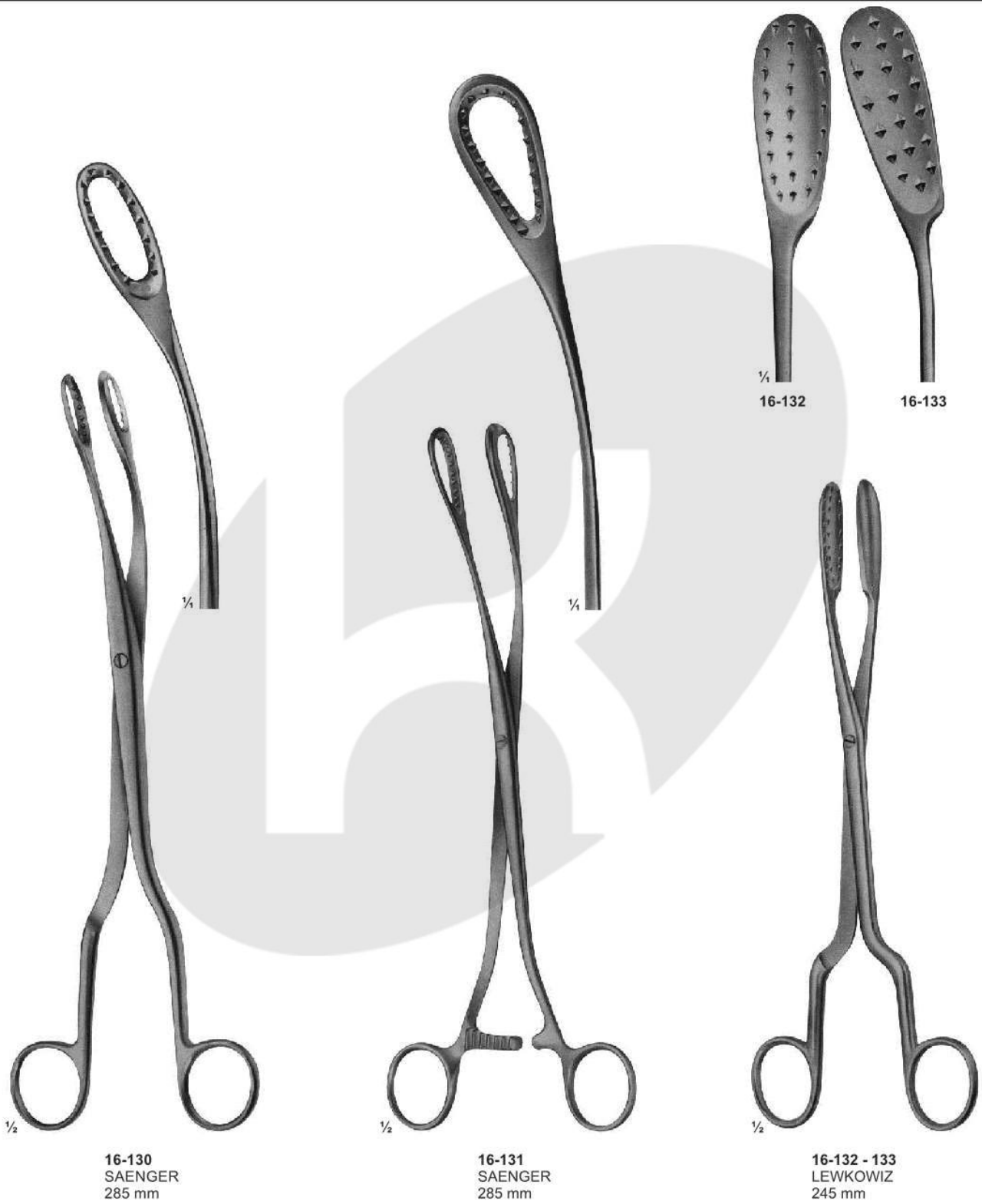

Obstetrics-Placenta, Ovum and Cranioclast, Basiotribe Forceps

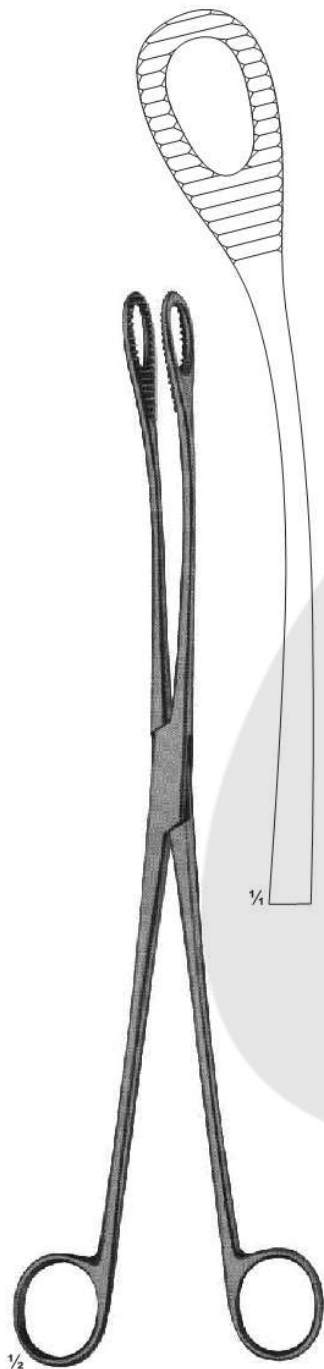

16-134
KELLY
320mm



16-135
SMELLIE
Perforator
270mm



16-136
BRAUN
Cranioclast
420mm

Tracheal Tubes with inner tubes



1/2

16-137
UECKERMANN-DENKER
 Cryothyrotomy trocar
 with silver cannula
 130mm

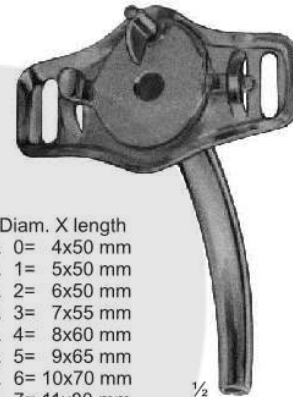

1/2

- Diam. X length
- 16-138** Fig. 0= 4x50 mm
 - 16-139** Fig. 1= 5x50 mm
 - 16-140** Fig. 2= 6x50 mm
 - 16-141** Fig. 3= 7x55 mm
 - 16-142** Fig. 4= 8x60 mm
 - 16-143** Fig. 5= 9x65 mm
 - 16-144** Fig. 6= 10x70 mm
 - 16-145** Fig. 7= 11x80 mm
 - 16-146** Fig. 8= 12x85 mm
 - 16-147** Fig. 9= 13x90 mm
 - 16-148** Fig. 10=14x90 mm

16-138 - 148
LUER
 German silver



1/2

16-149 - 158
JACKSON
 German Silver

- Diam. X length
- 16-149** Fig. 0= 4x50 mm
 - 16-150** Fig. 1= 5x58 mm
 - 16-151** Fig. 2= 6x58 mm
 - 16-152** Fig. 3= 7x70 mm
 - 16-153** Fig. 4= 8x78 mm
 - 16-154** Fig. 5= 9x84 mm
 - 16-155** Fig. 6= 10x84 mm
 - 16-156** Fig. 7= 11x86 mm
 - 16-157** Fig. 8= 12x88 mm
 - 16-158** Fig. 9= 13x90 mm



1/2

- Diam. X length
- 16-159** Fig. 1= 5x48 mm
 - 16-160** Fig. 2= 6x58 mm
 - 16-161** Fig. 3= 7x70 mm
 - 16-162** Fig. 4= 8x78 mm
 - 16-163** Fig. 5= 9x84 mm
 - 16-164** Fig. 6= 10x84 mm
 - 16-165** Fig. 7= 11x86 mm
 - 16-166** Fig. 8= 12x88 mm
 - 16-167** Fig. 9= 13x90 mm
 - 16-168** Fig.10= 14x90 mm

16-159 - 168
JACKSON
 German Silver

Tound-and Tracheal Hooks and Dilators



16-169
BOSE
165 mm



16-170
BOSE
165 mm

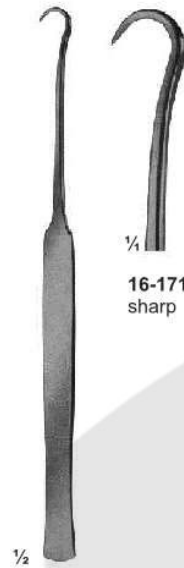

16-171 - 173
180 mm

16-171
sharp



16-172
blunt

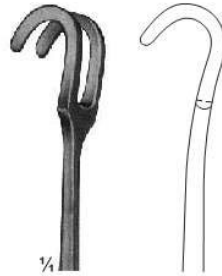

16-173
stumpf/blunt



16-174
FINSEN
50 mm

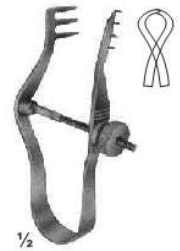

16-175
FINSEN
70 mm



16-176
TROUSSEAU
120 mm



16-177
LABORDE
125 mm

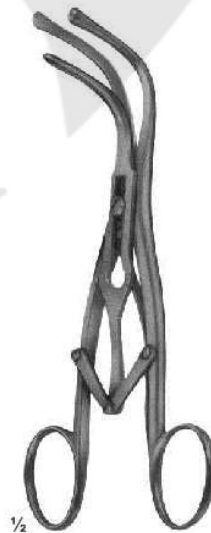

16-178
LABORDE
strong pattern
135 mm



16-179
Cleaning Brush
for tracheal tubes
285 mm

Irrigating Cannulae, Embolus Grasping Forceps, Dilators

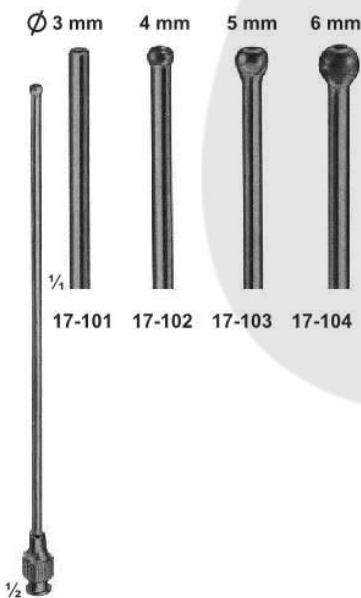

17-101 - 104
SCHMID
 Vessel irrigating cannulae,
 malleable, silver plated
 150 mm

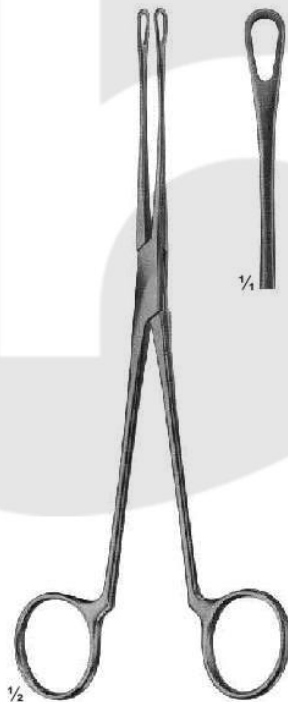

17-105
BLAKE
 Embolus grasping
 forceps
 205 mm

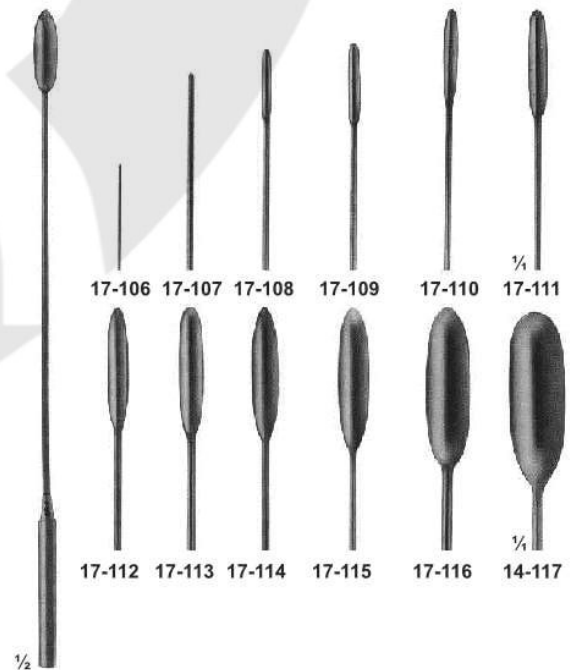

17-106 - 117
DE BAKEY
 Vascular dilators,
 malleable
 190 mm

17-106	0,5 mm ∅	17-112	3,5 mm ∅
17-107	1,0 mm ∅	17-113	4,0 mm ∅
17-108	1,5 mm ∅	17-114	4,5 mm ∅
17-109	2,0 mm ∅	17-115	5,0 mm ∅
17-110	2,5 mm ∅	17-116	7,0 mm ∅
17-111	3,0 mm ∅	17-117	9,0 mm ∅

Irrigating Cannulae, Embolus Grasping Forceps, Dilators

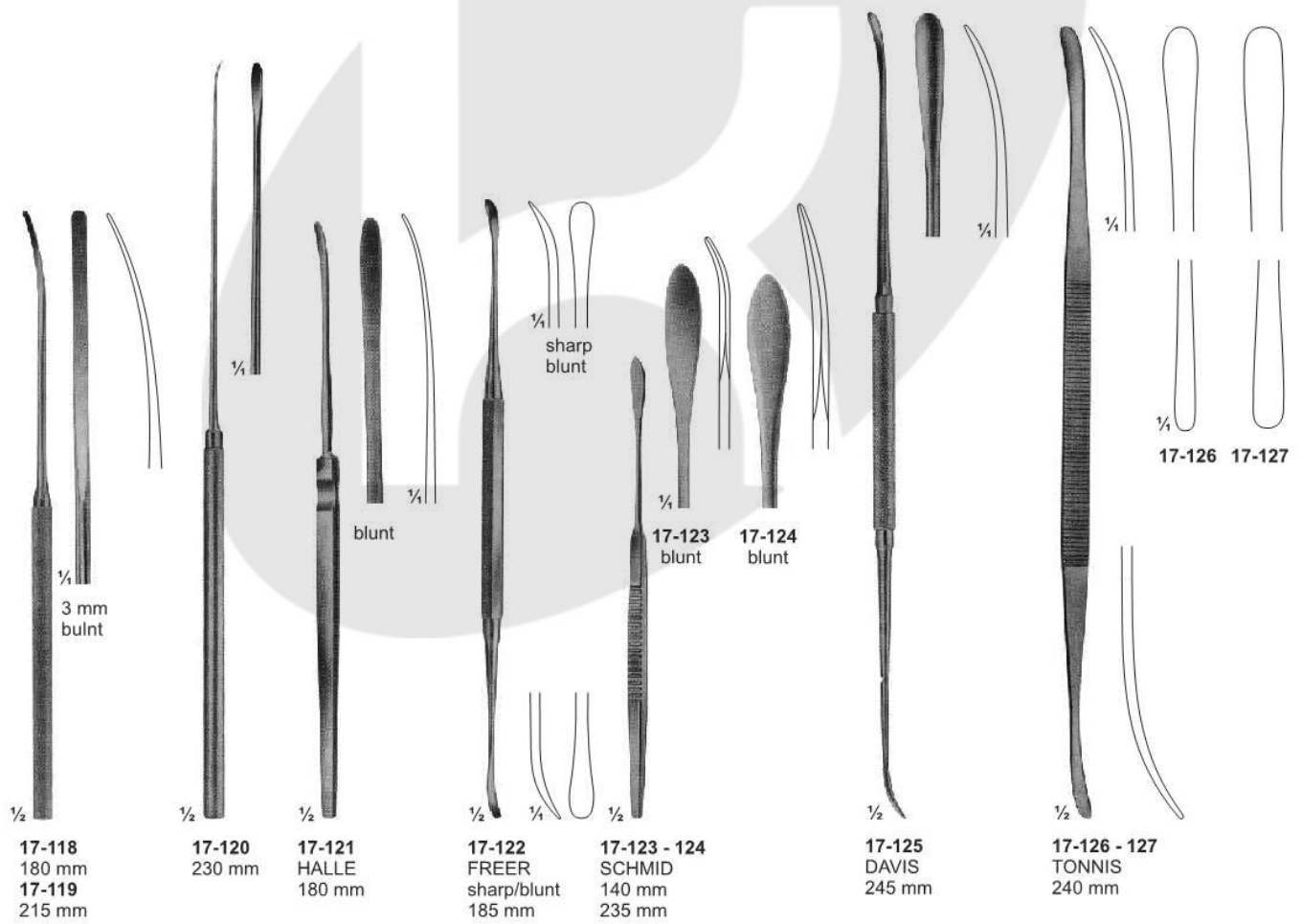

Irrigating Cannulae, Embolus Grasping Forceps, Dilators

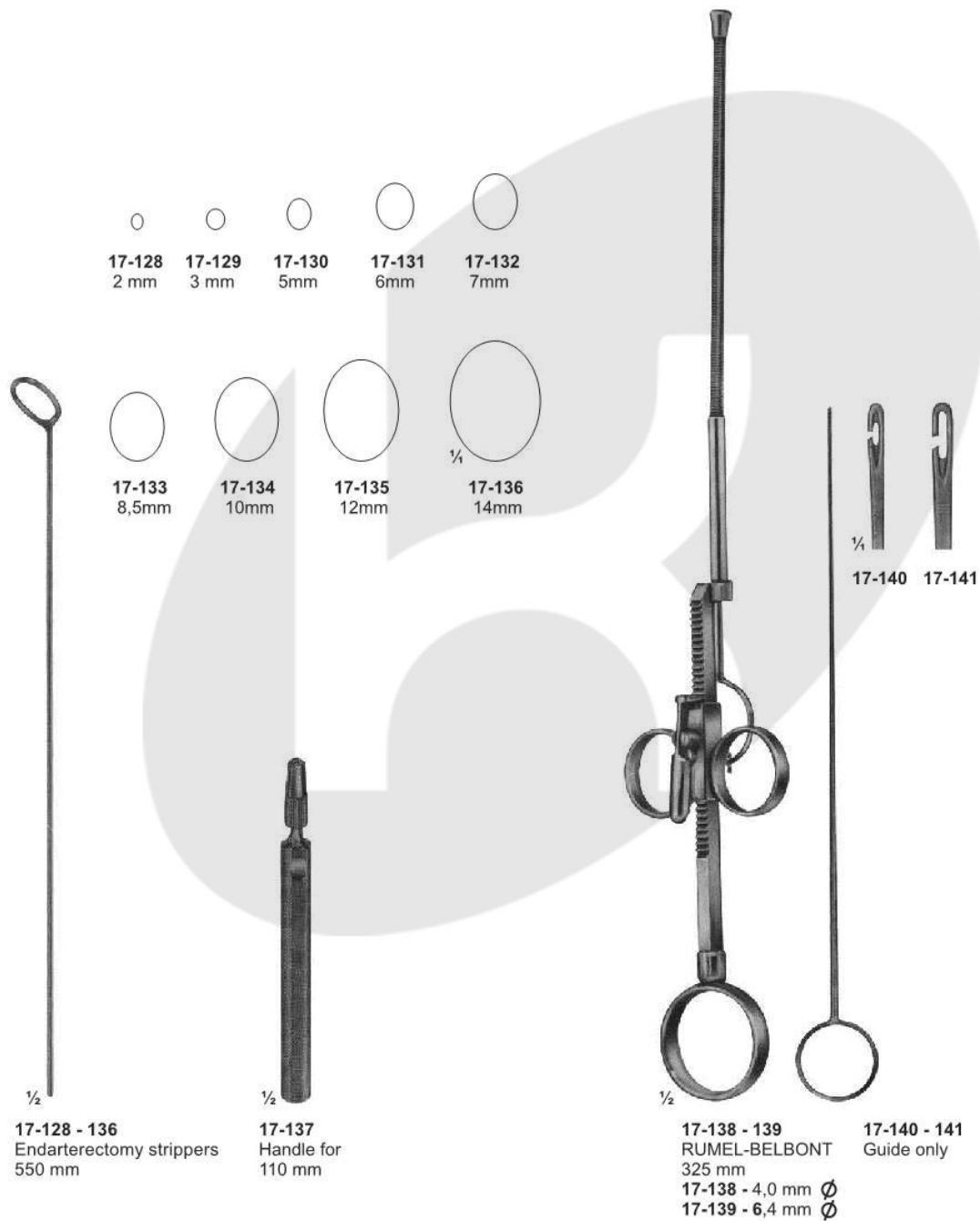

Biopotome and Aortic Dilators

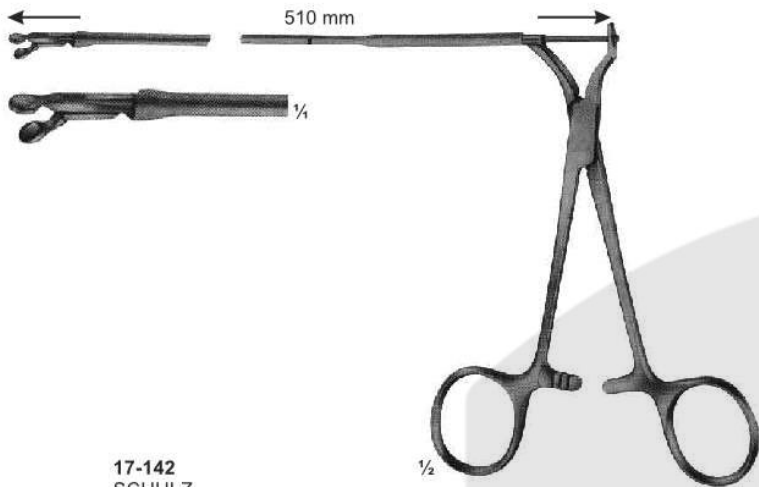

17-142
SCHULZ
 Biopotome, mit flexiblem Schaft, 510 mm lang,
 with round jaws 3 mm diam.

Biopsy forceps, for biopsy from the right atrium
 through cava jugularis, prior to heart implantations.

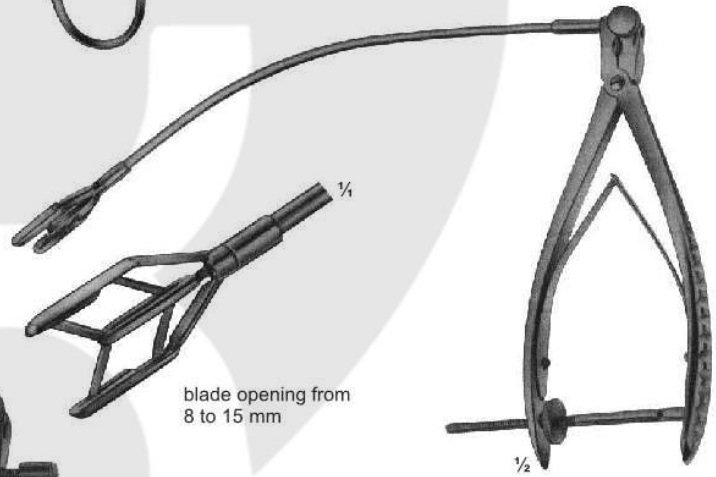

17-144
COOLEY
 Dilator for
 mitral valve
 for children

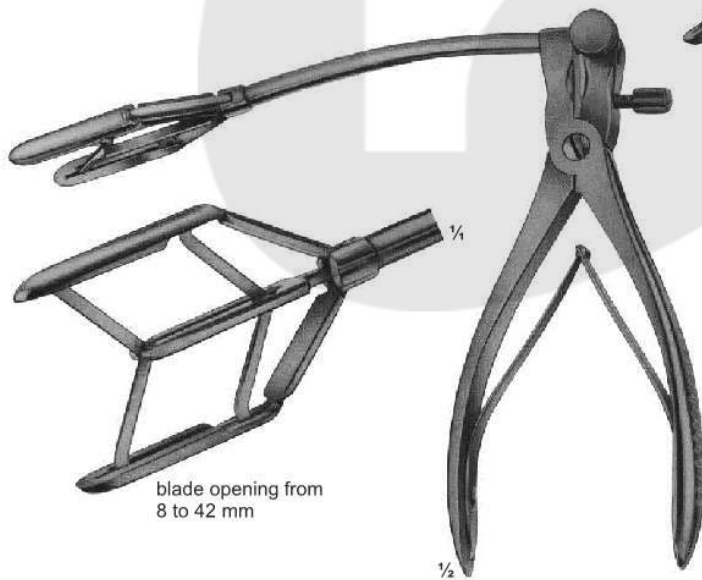

17-143
TUBBS
 Dilator for
 mitral valve

Biopotome and Aortic Dilators

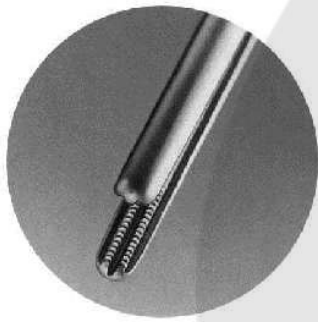
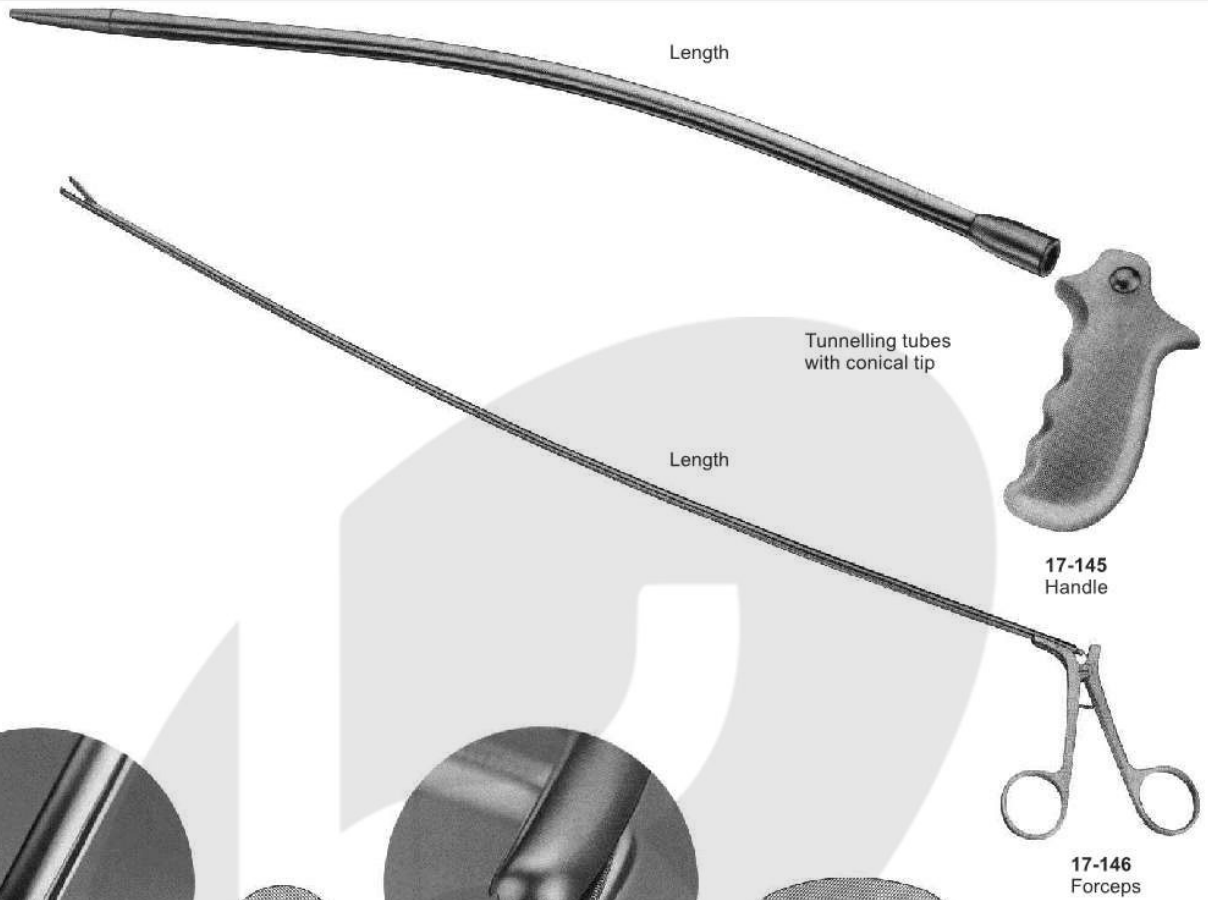

DE BAKEY
17-147
1 : 2 rows of teeth



DE BAKEY
17-148
2 : 3 rows of teeth

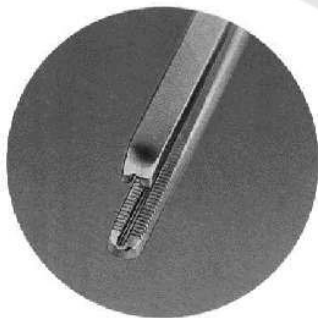
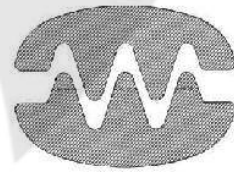

COOLEY
17-149
2 : 2 rows of teeth

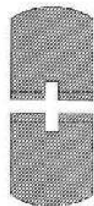

DARDIK
17-150
2 : 3 rows of teeth



Ultra-Light-Forceps



17-151
Width of jaws
1,5 mm
Length
150mm

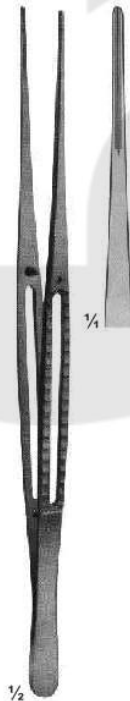

17-152
1,5 mm
200 mm



17-153
1,5 mm
240 mm



17-154
1,5 mm
300 mm

Ultra-Light-Forceps

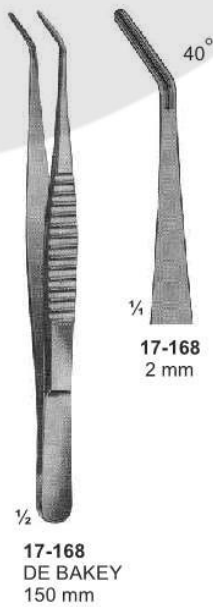
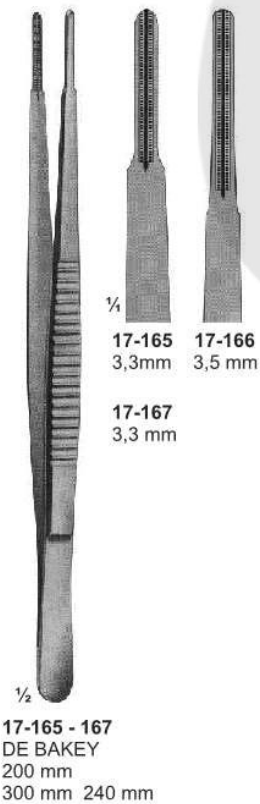
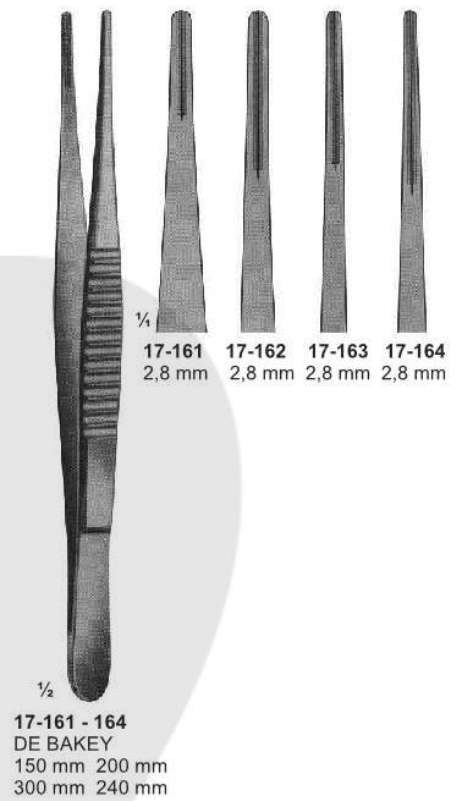
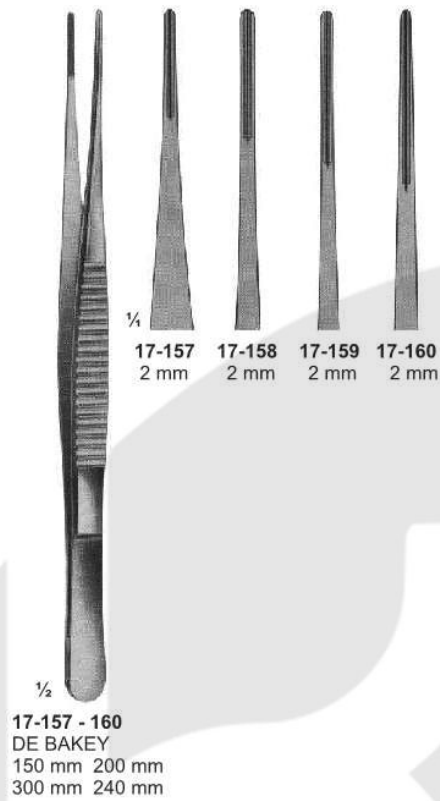
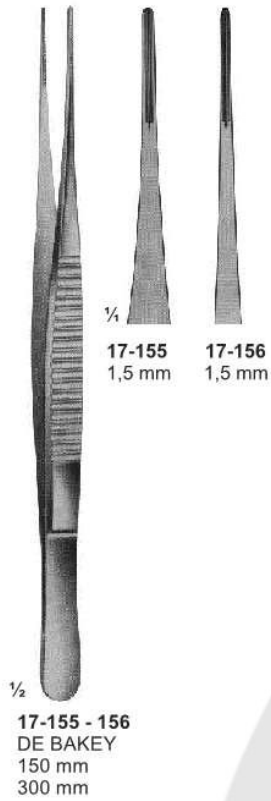

Ring Handle Bulldog Clamps

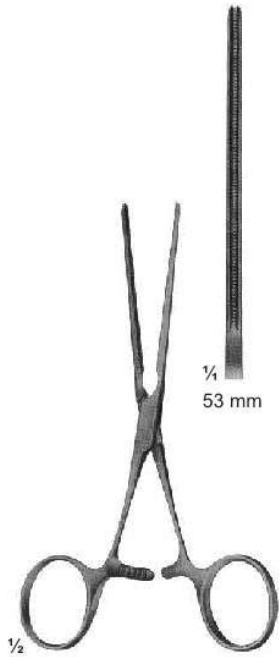

17-170
DE-BAKEY
gerade straight
130 mm

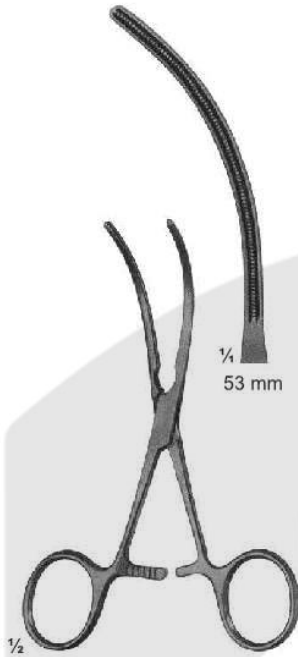

17-171
DE-BAKEY
Maul gebogen
curved jaws
125 mm

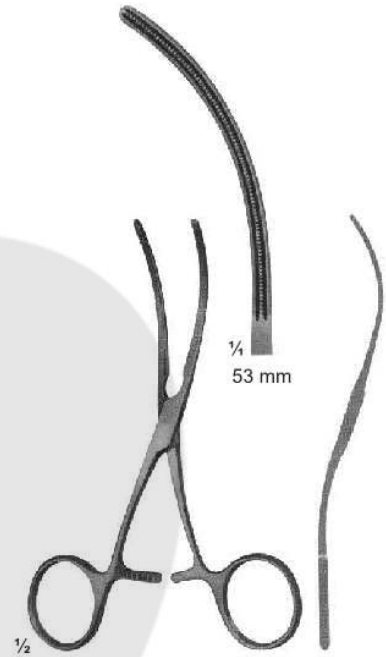

17-172
DE-BAKEY
S-shaped curved
125 mm

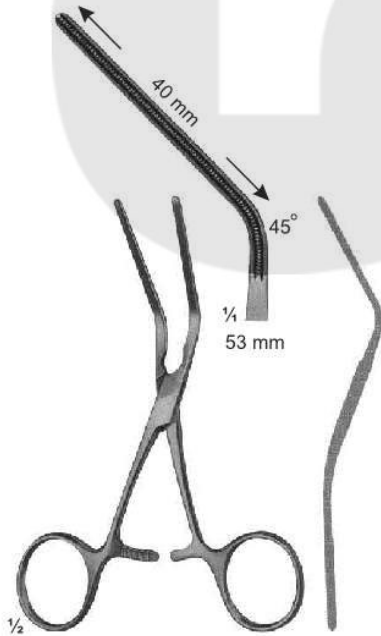

17-173
DE-BAKEY
45° winklig gebogen
angled 45°
125 mm

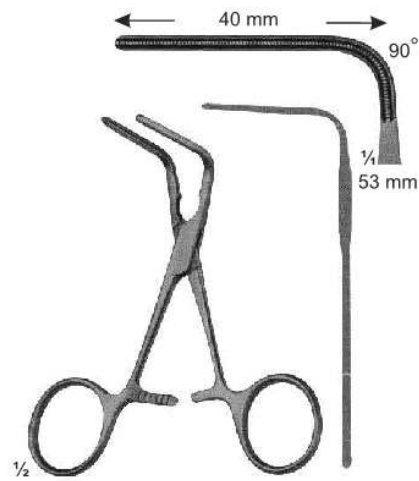

17-174
DE-BAKEY
90° winklig gebogen
angled 90°
105 mm

Anastomosis-and Multi-Purpose-Clamps for Neonatales

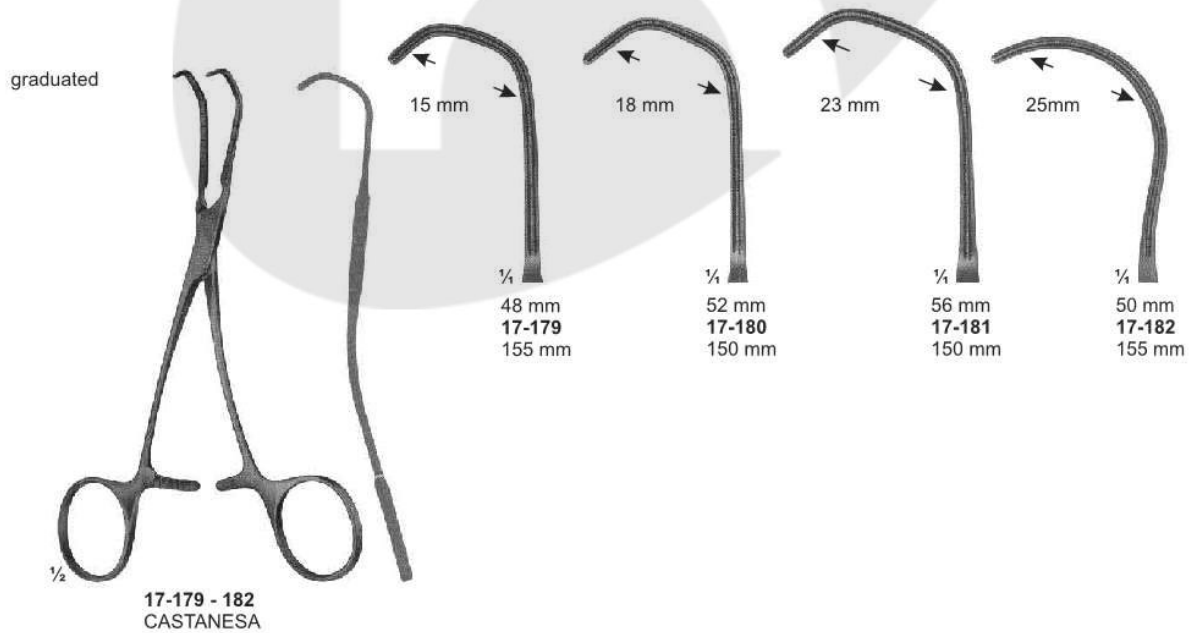
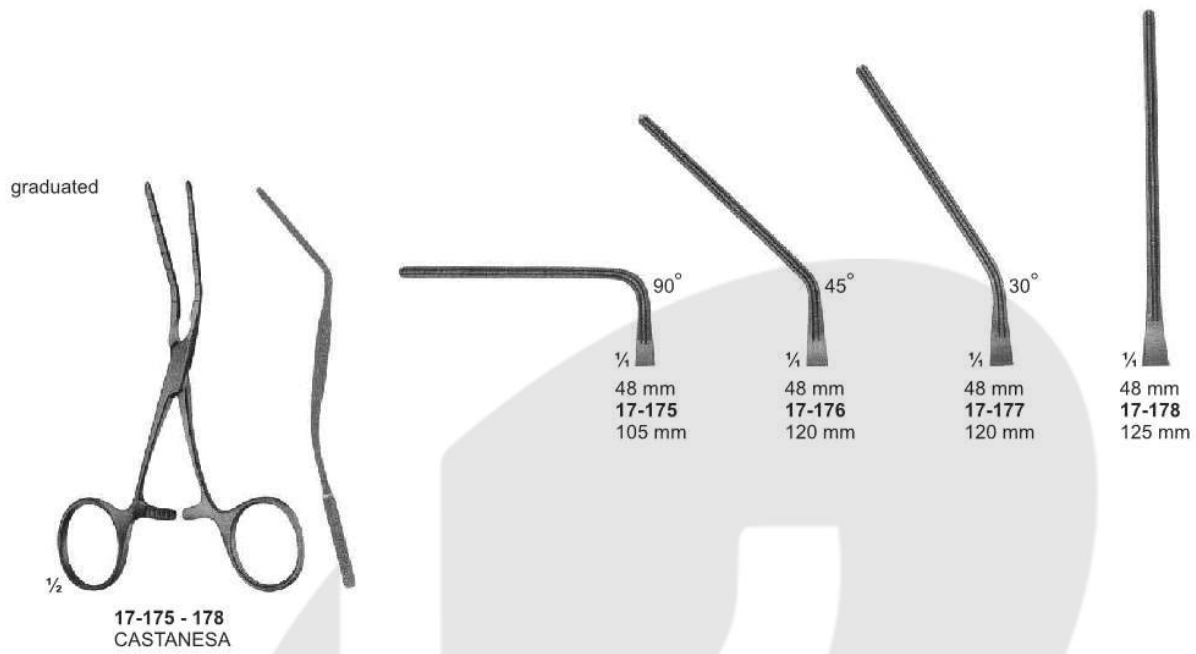

Anastomosis-and Multi-Purpose-Clamps-Pediatric types

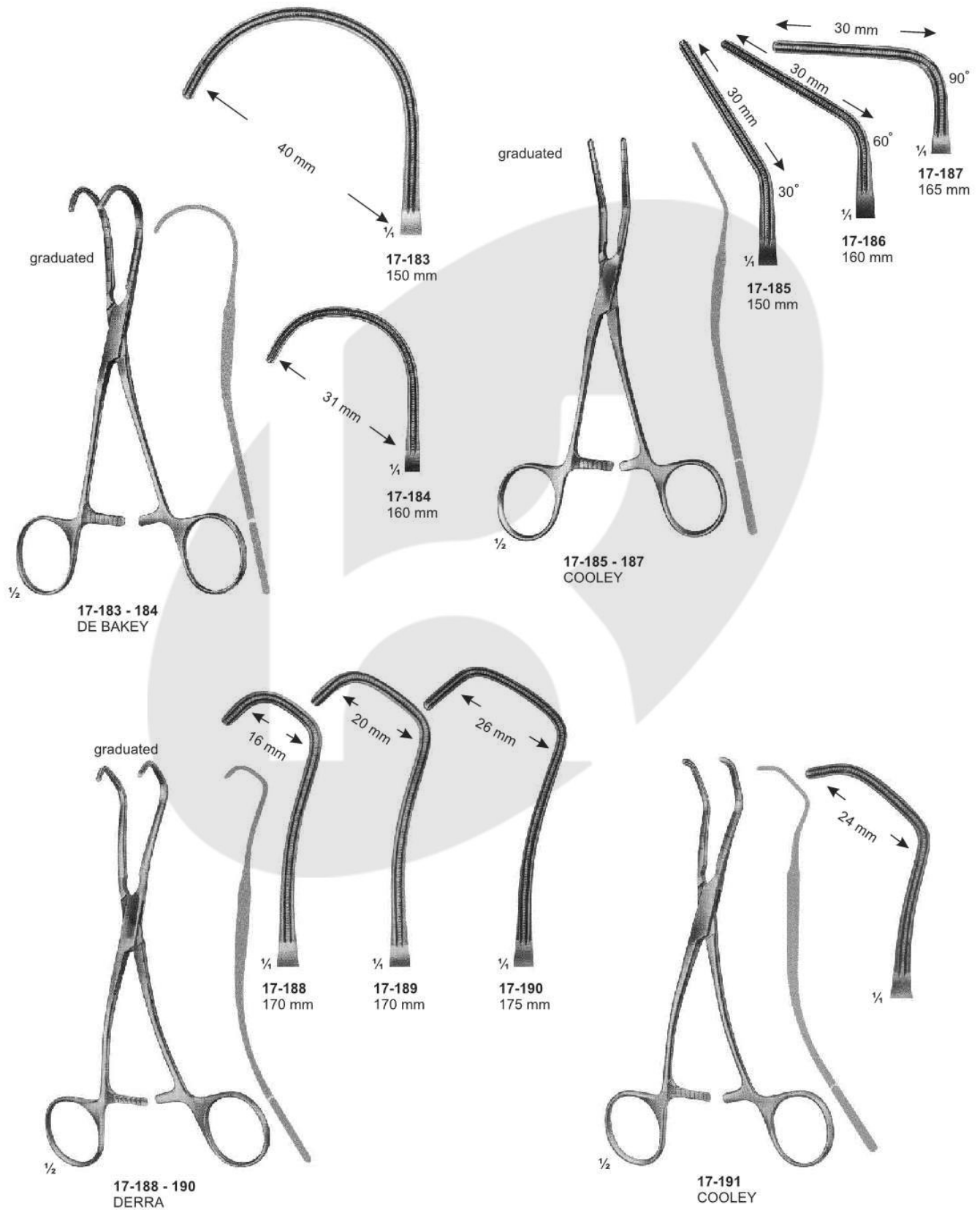

Non-traumatic Haemostatic Forceps

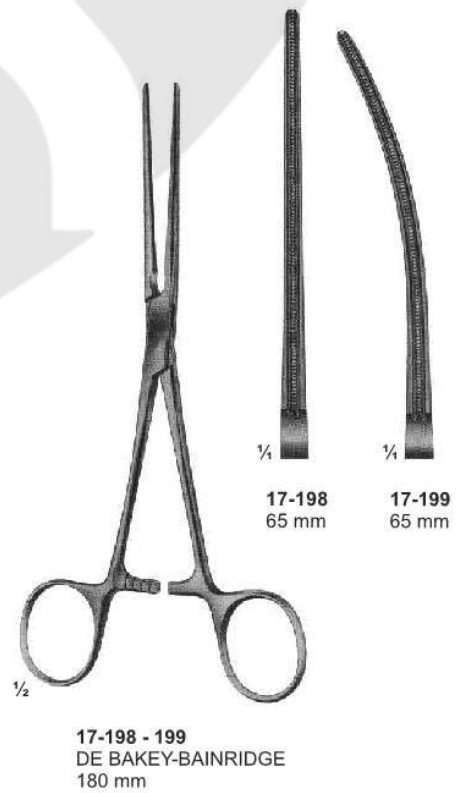
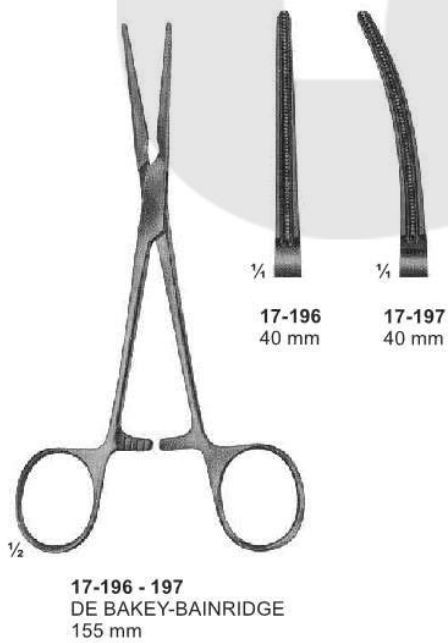
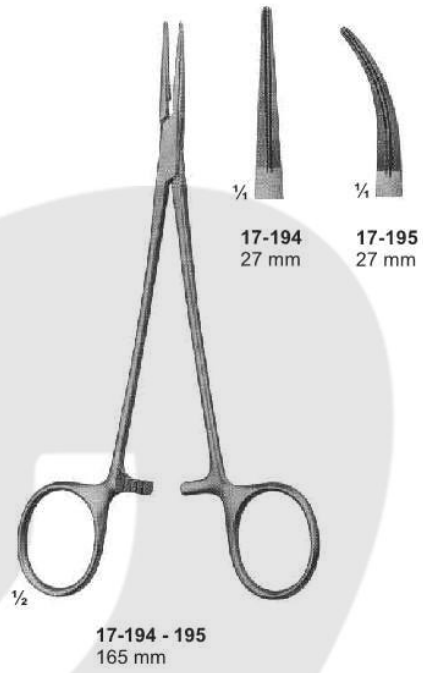
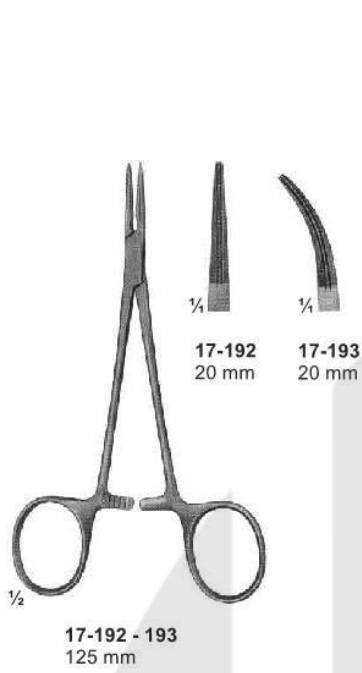

Non-traumatic Haemostatic Forceps

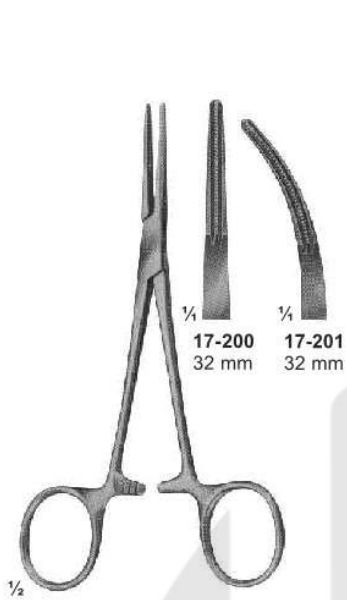

17-200 - 201
DE-BAKEY-KELLY
140 mm

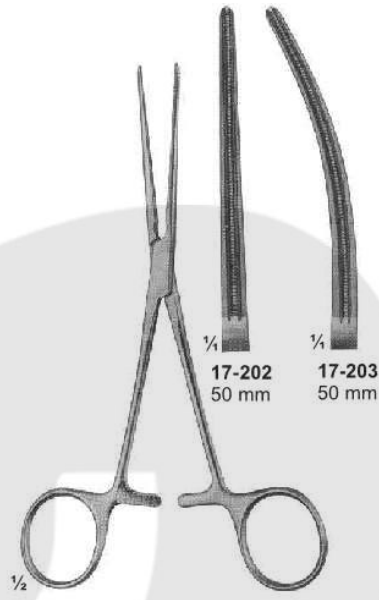

17-202 - 203
PEAN
155 mm

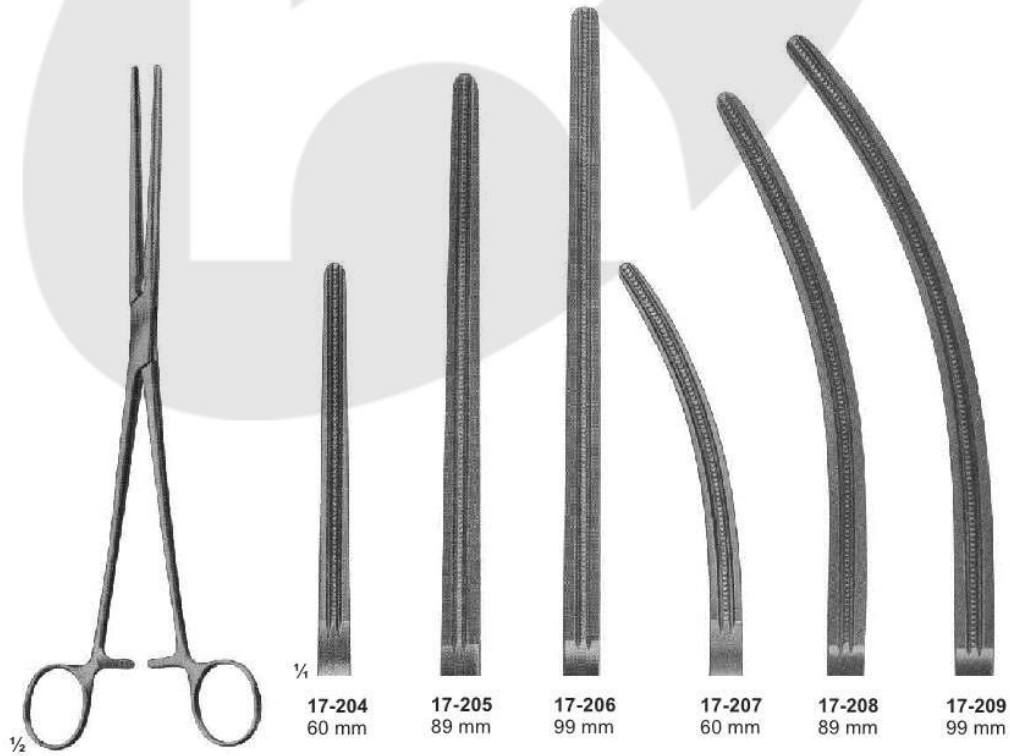

17-204 - 209
DE-BAKEY-PEAN DE-BAKEY-PEAN
17-204 200 mm 17-207 200 mm
17-205 265 mm 17-208 260 mm
17-206 280 mm 17-209 275 mm

Anastomosis Clamps

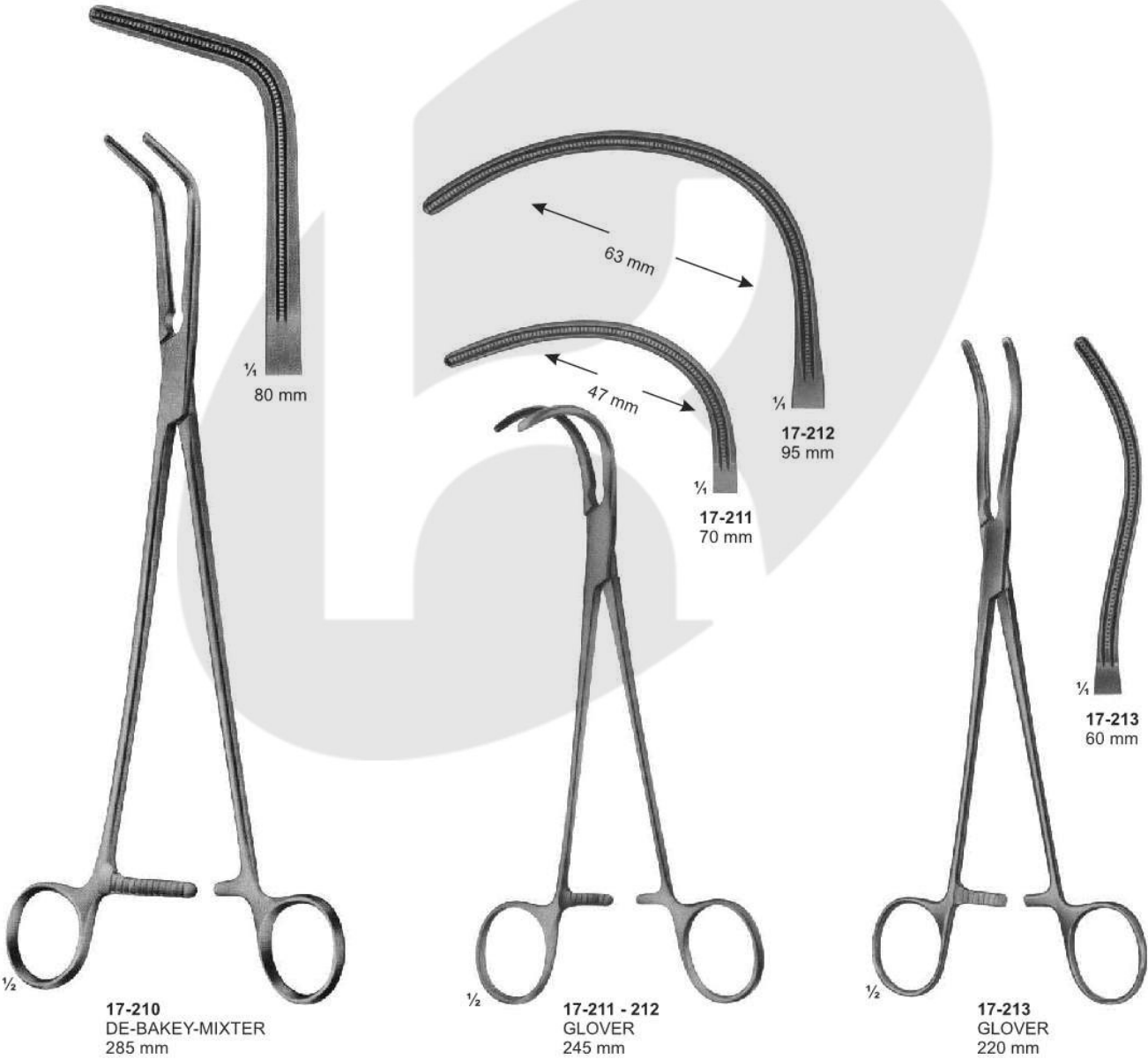

Vena-Cava Clamps

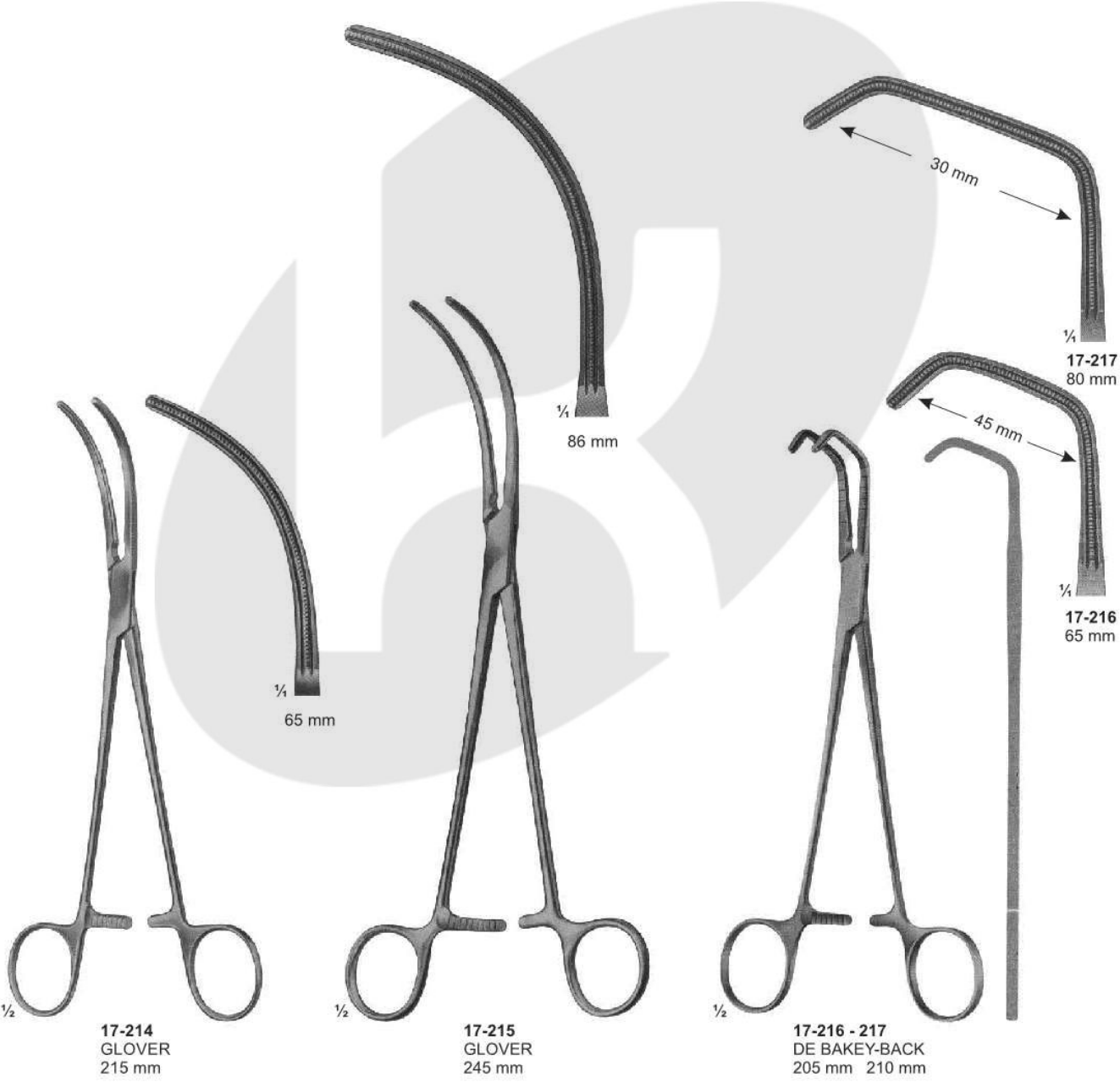

1/2
17-214
 GLOVER
 215 mm

1/2
17-215
 GLOVER
 245 mm

1/2
17-216 - 217
 DE BAKEY-BACK
 205 mm 210 mm

Vena-Cava Clamps

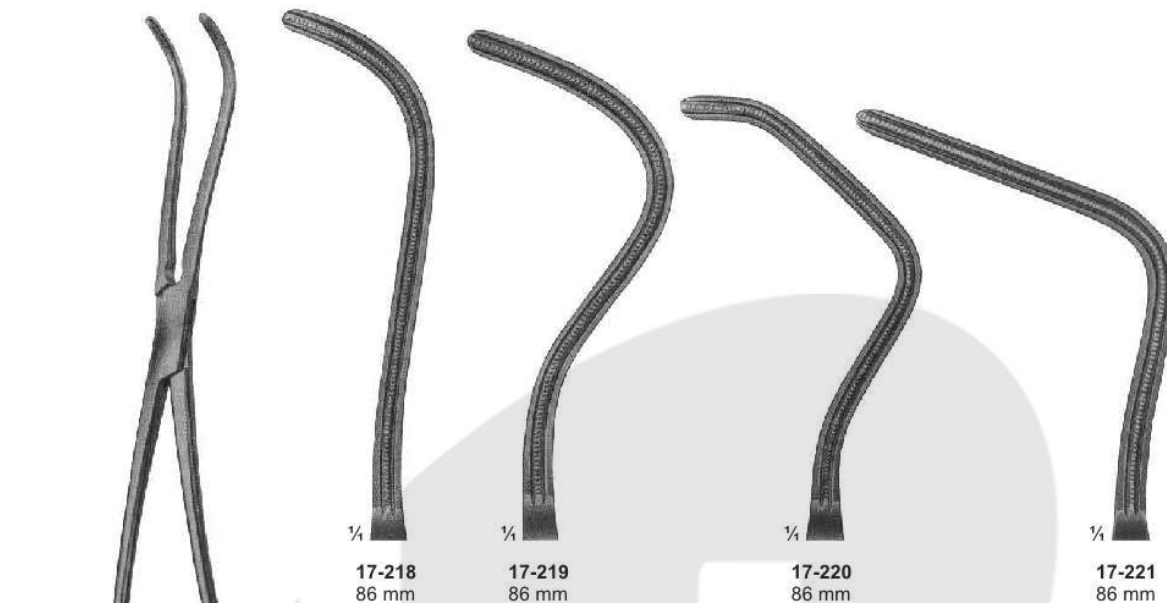

17-218 86 mm
17-219 86 mm
17-220 86 mm
17-221 86 mm

17-218 - 221
DE BAKEY-HARKEN
 17-218 - 255 mm
 17-219 - 245 mm
 17-220 - 245 mm
 17-221 - 245 mm

1/2

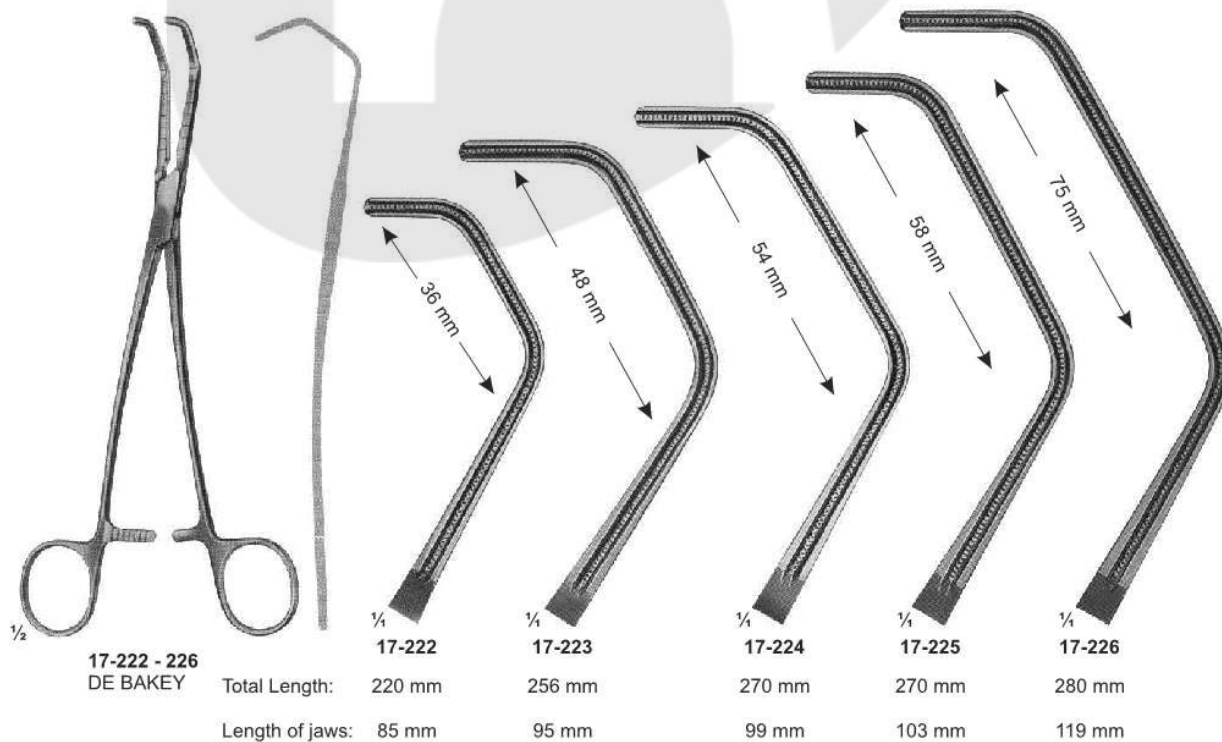

17-222 - 226
DE BAKEY

Model	Total Length	Length of jaws
17-222	220 mm	85 mm
17-223	256 mm	95 mm
17-224	270 mm	99 mm
17-225	270 mm	103 mm
17-226	280 mm	119 mm

Vena-Cava Clamps



17-227 - 229
DE BAKEY-SATINSKY
 235 mm, 240 mm, 245 mm

17-227
 68 mm

17-228
 76 mm

17-229
 84 mm

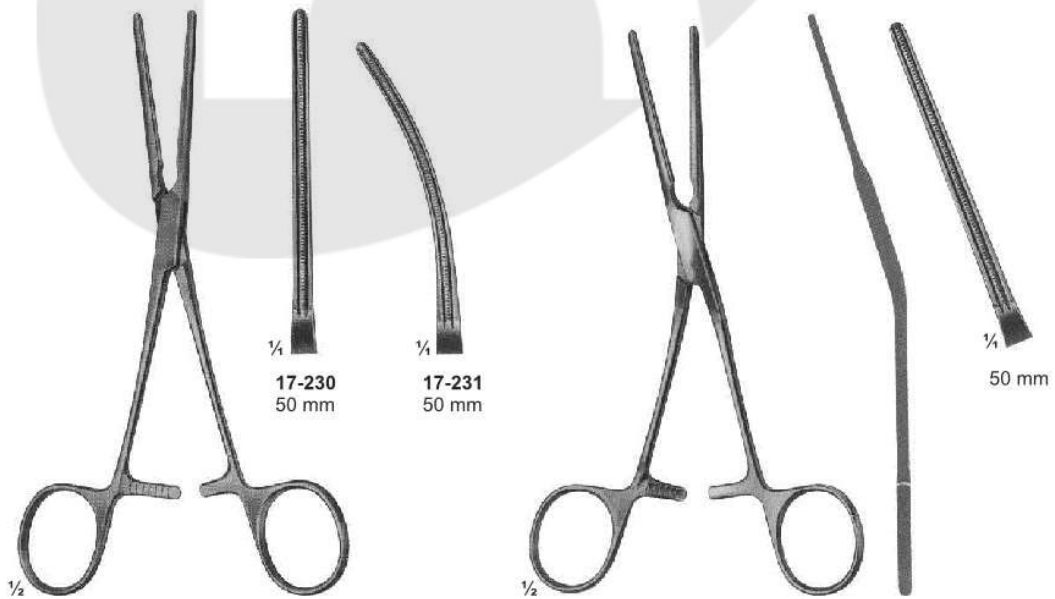

17-230 - 231
DE BAKEY
 170 mm, 165 mm

17-232
DE BAKEY
 165 mm

Vena-Cava Clamps

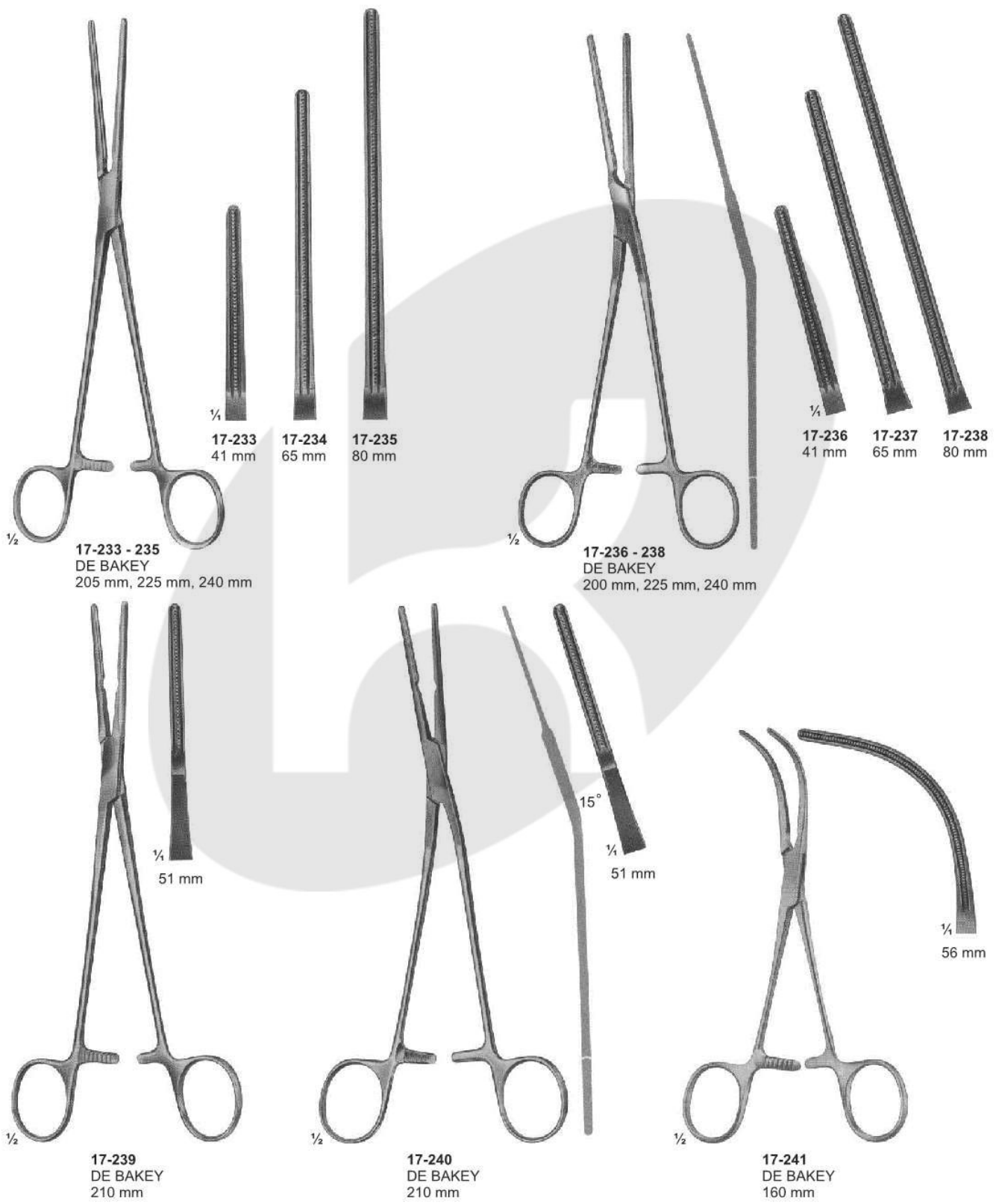

Vena-Cava Clamps

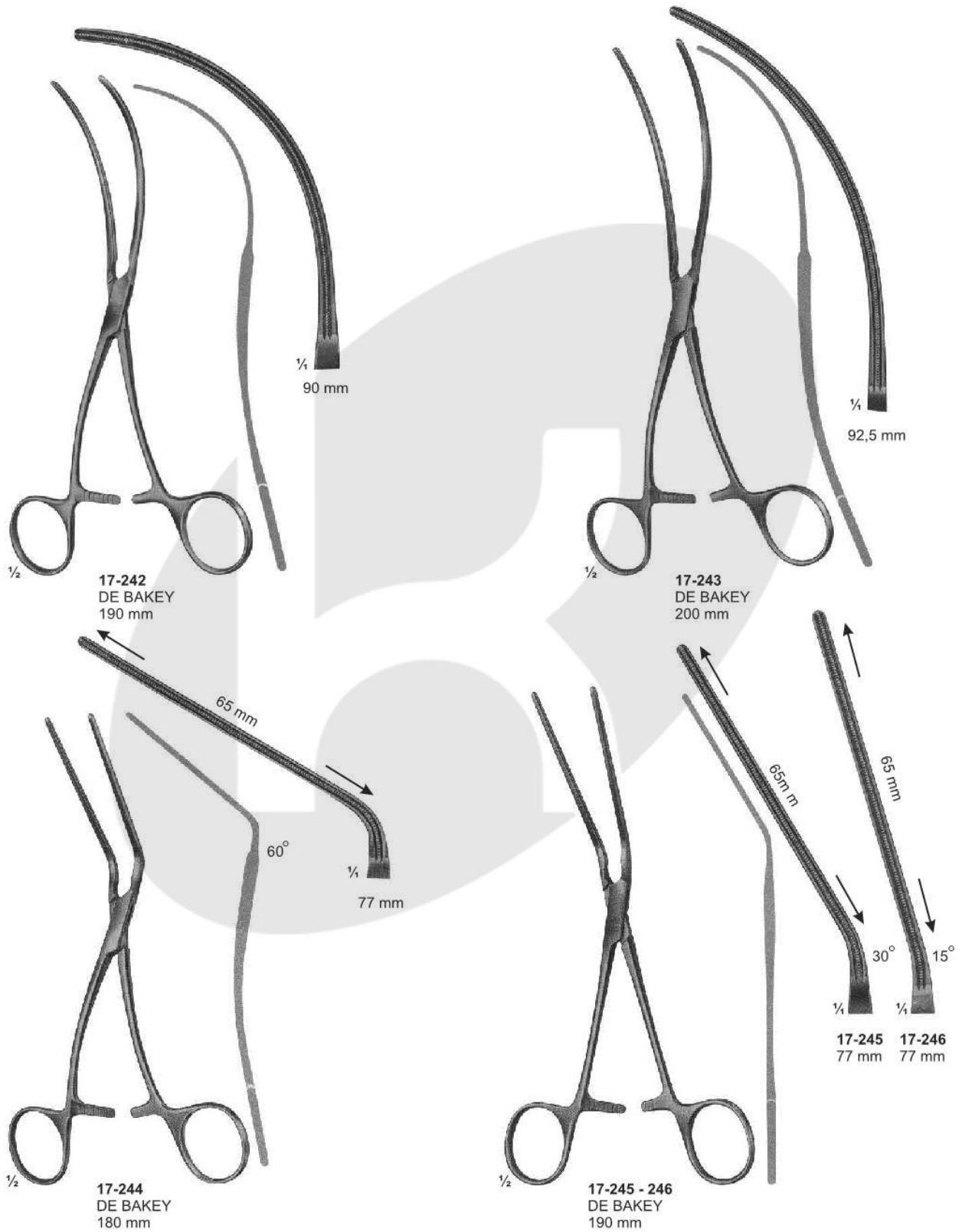

Vena-Cava Clamps



17-247
LELAND-JONES
195 mm



17-248
DE BAKÉY
200 mm
Iliac clamp

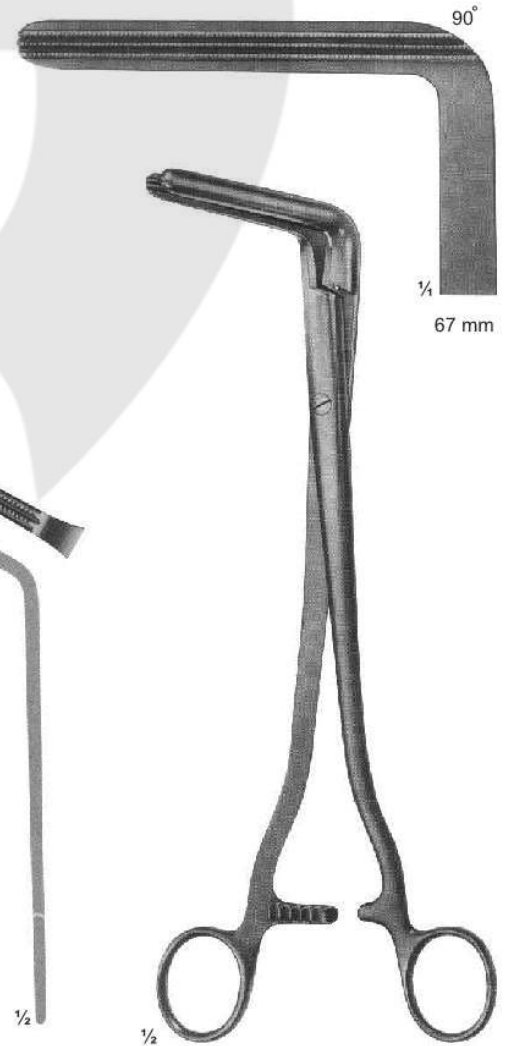

17-249
WERTHEIM
250 mm

Vena-Cava Clamps

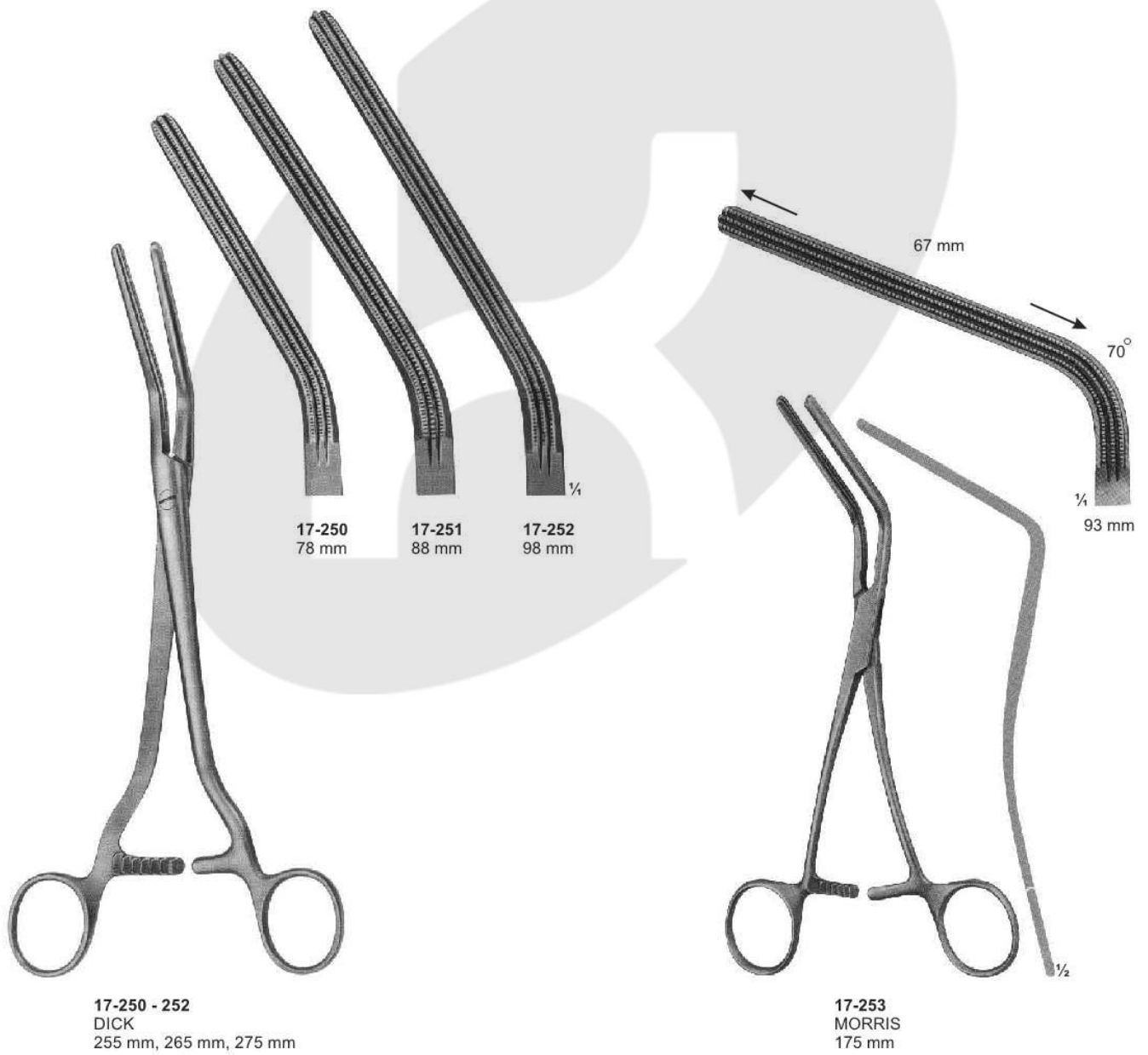

Vena-Cava Clamps

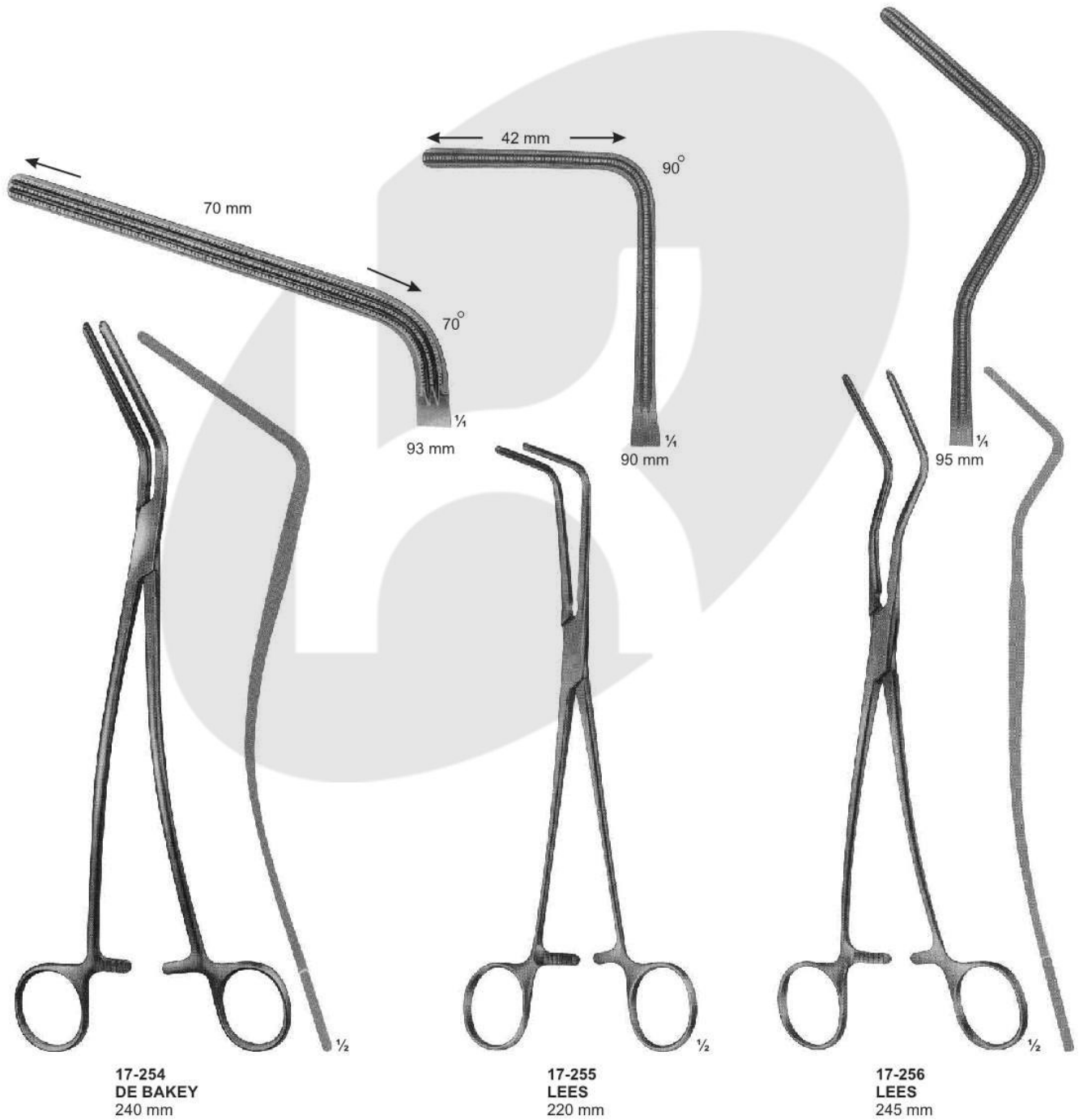

Vena-Cava Clamps

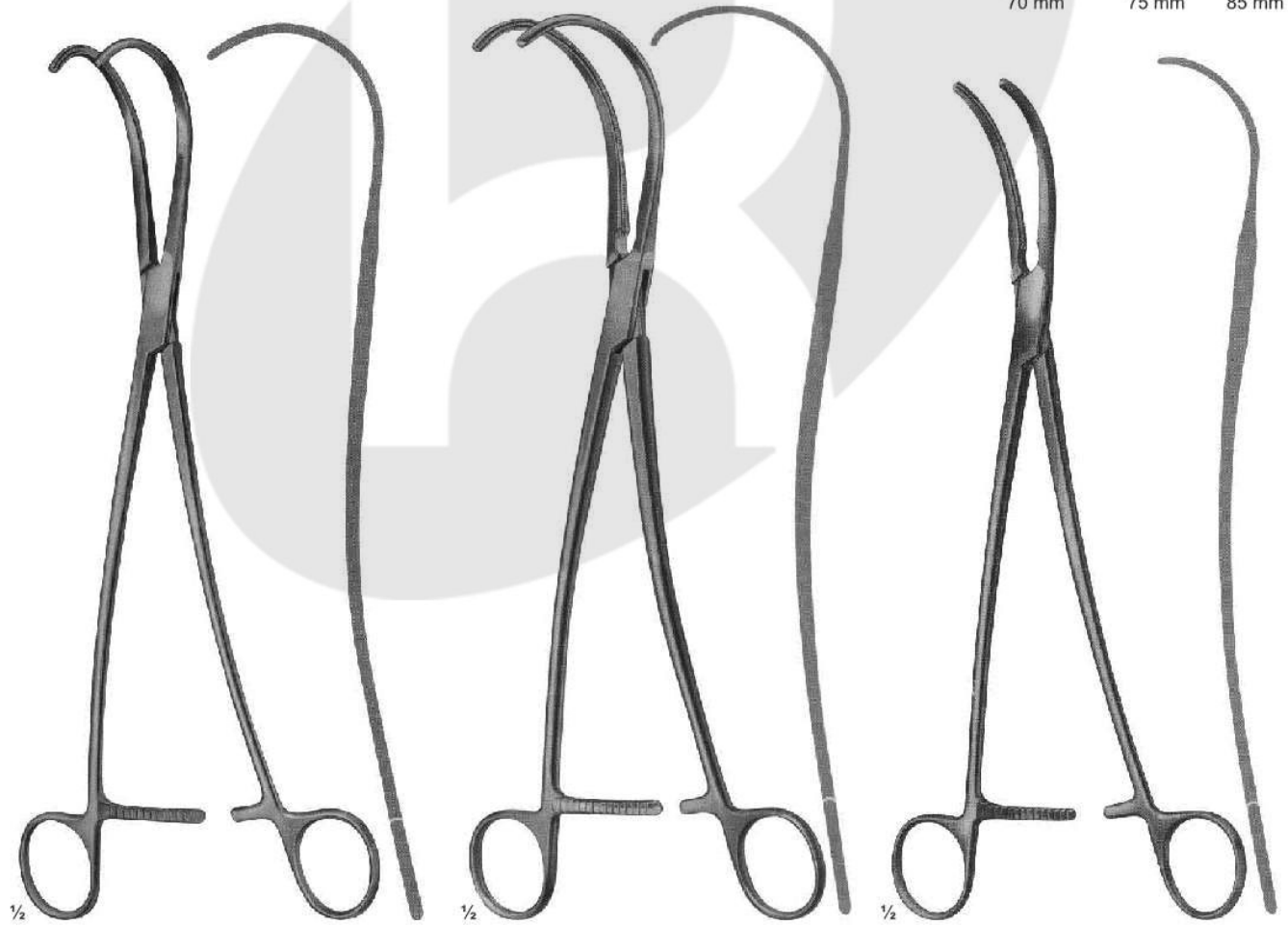
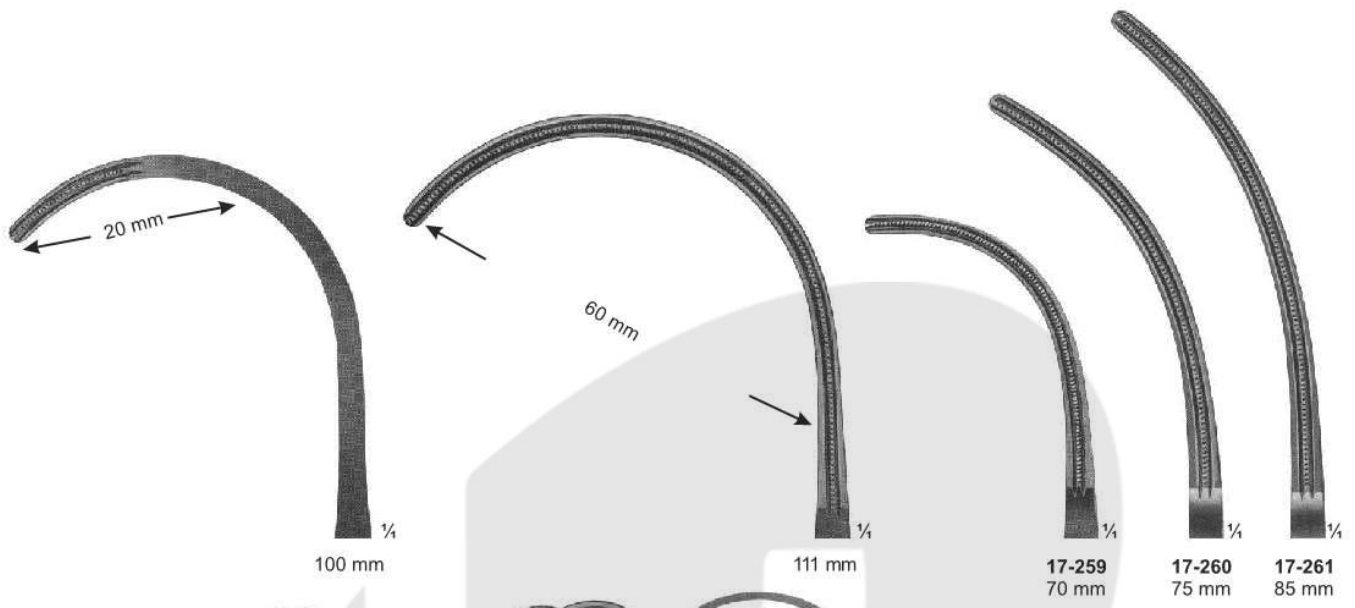

**17-257
DE BAKEY**
265 mm

**17-258
DE BAKEY**
270 mm

**17-259 - 261
DE BAKEY**
255 mm, 265 mm, 280 mm

Vena-Cava Clamps

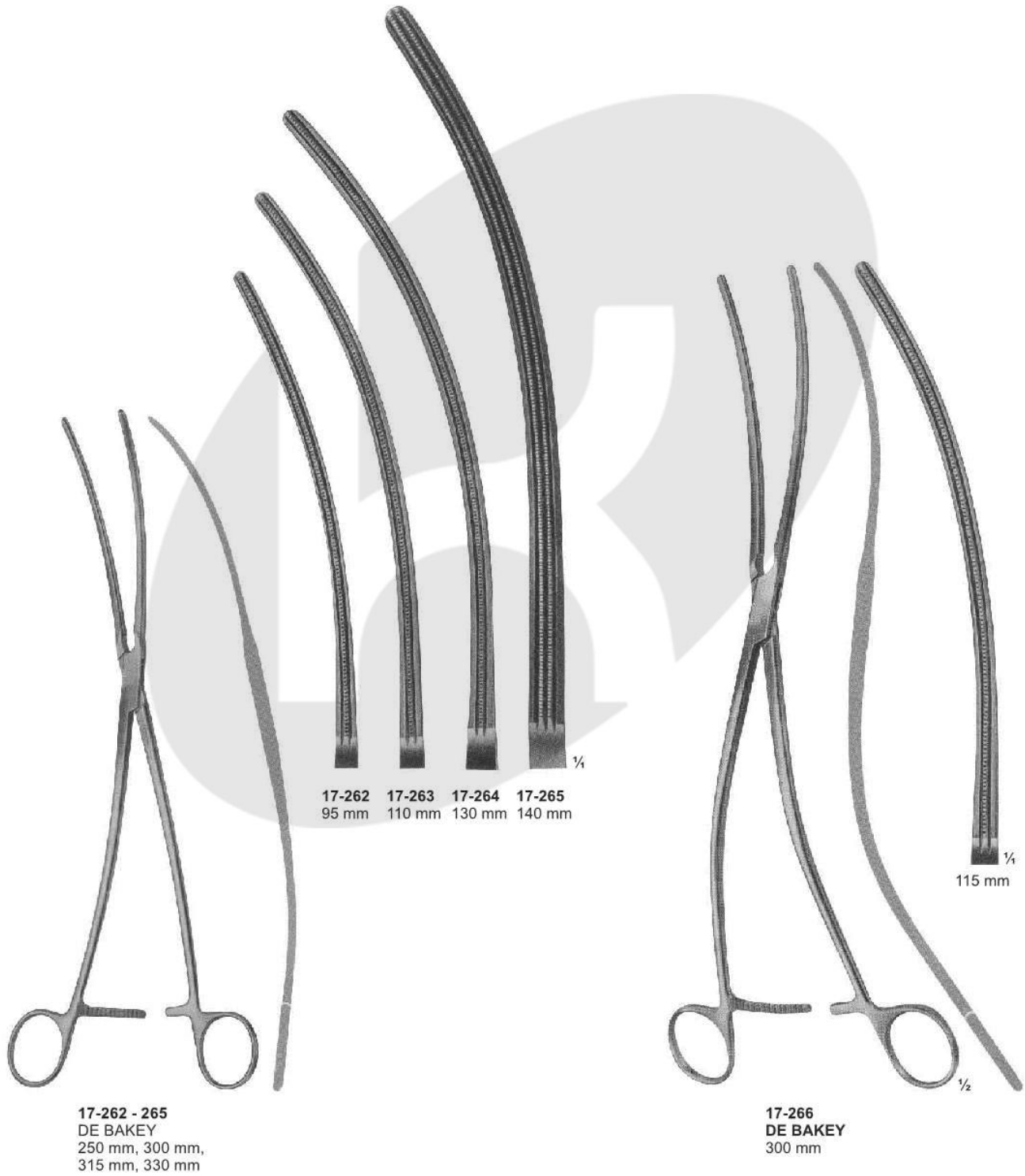

Vena-Cava Clamps



**17-267
DIETRICH**
210 mm

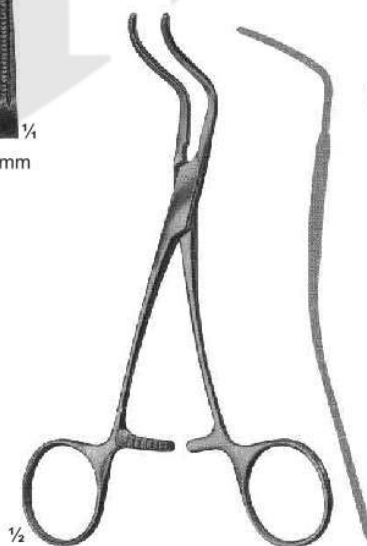
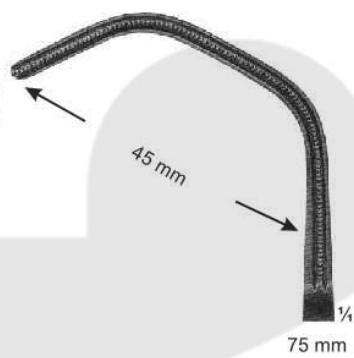

**17-268
SUBRAMANIAN**
155 mm

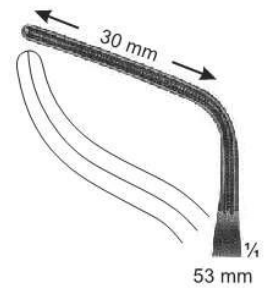

Vena-Cava Clamps

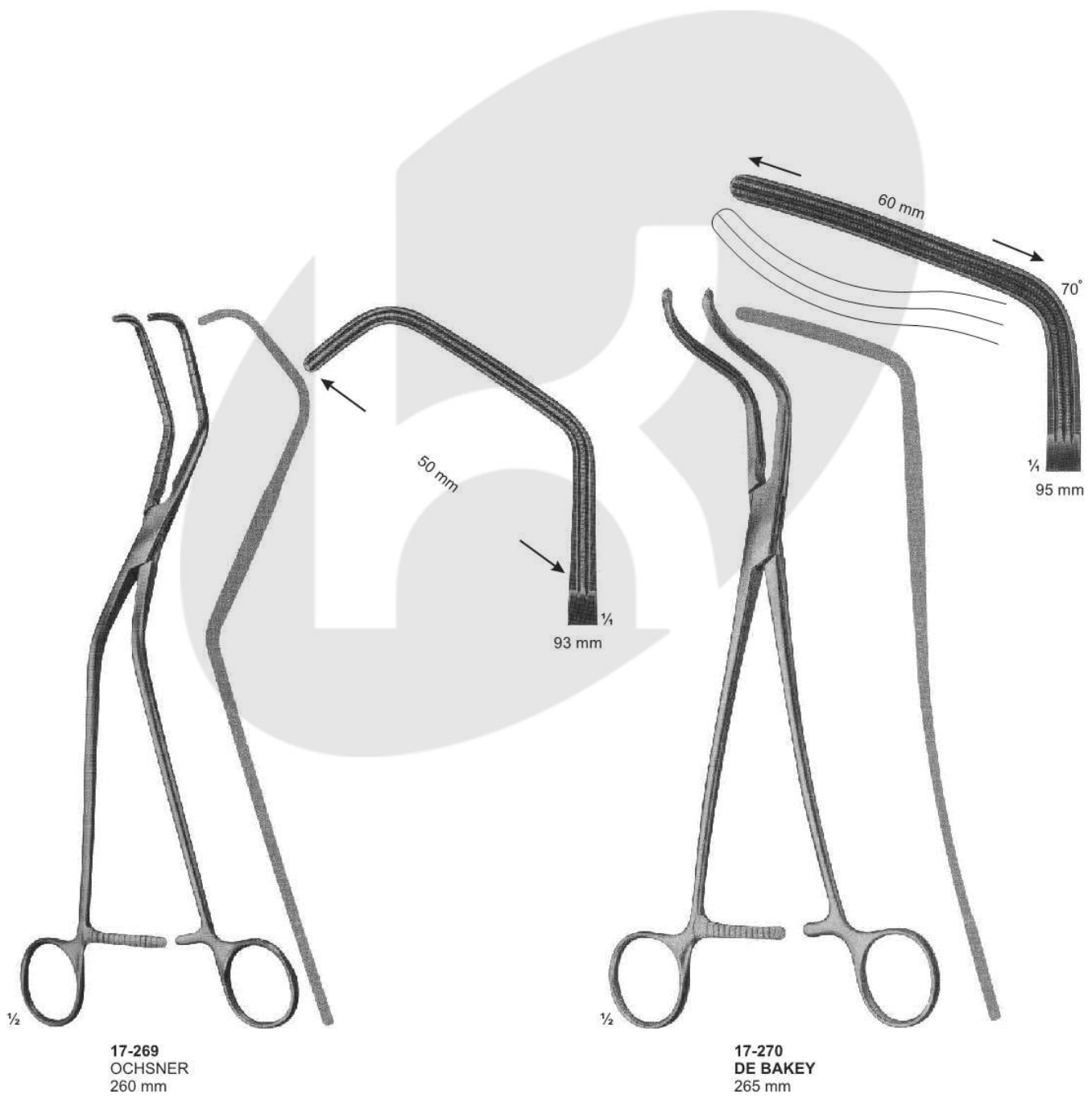

Aorta-Anastomosis Clamps

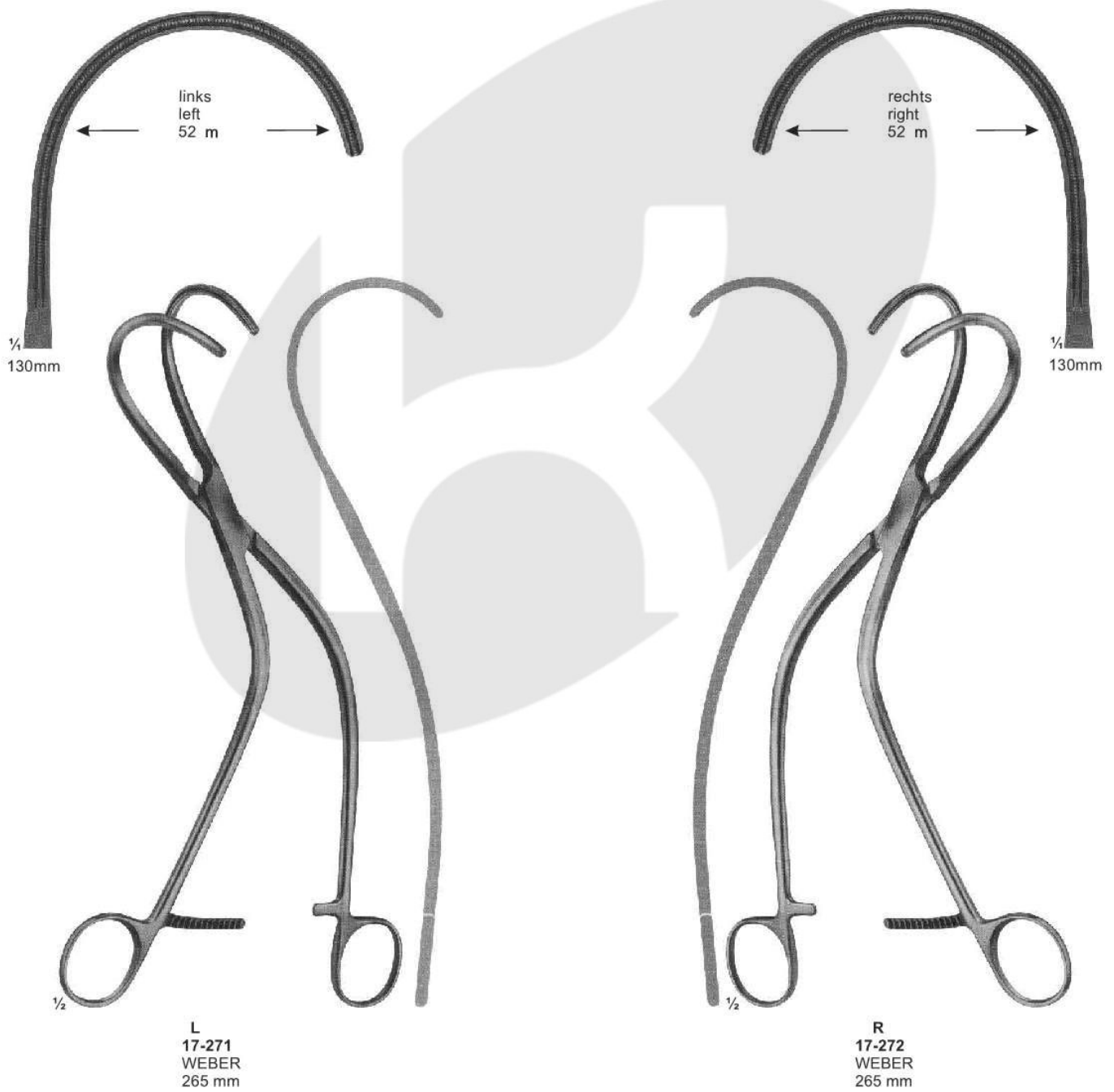

Aorta-Anastomosis Clamps

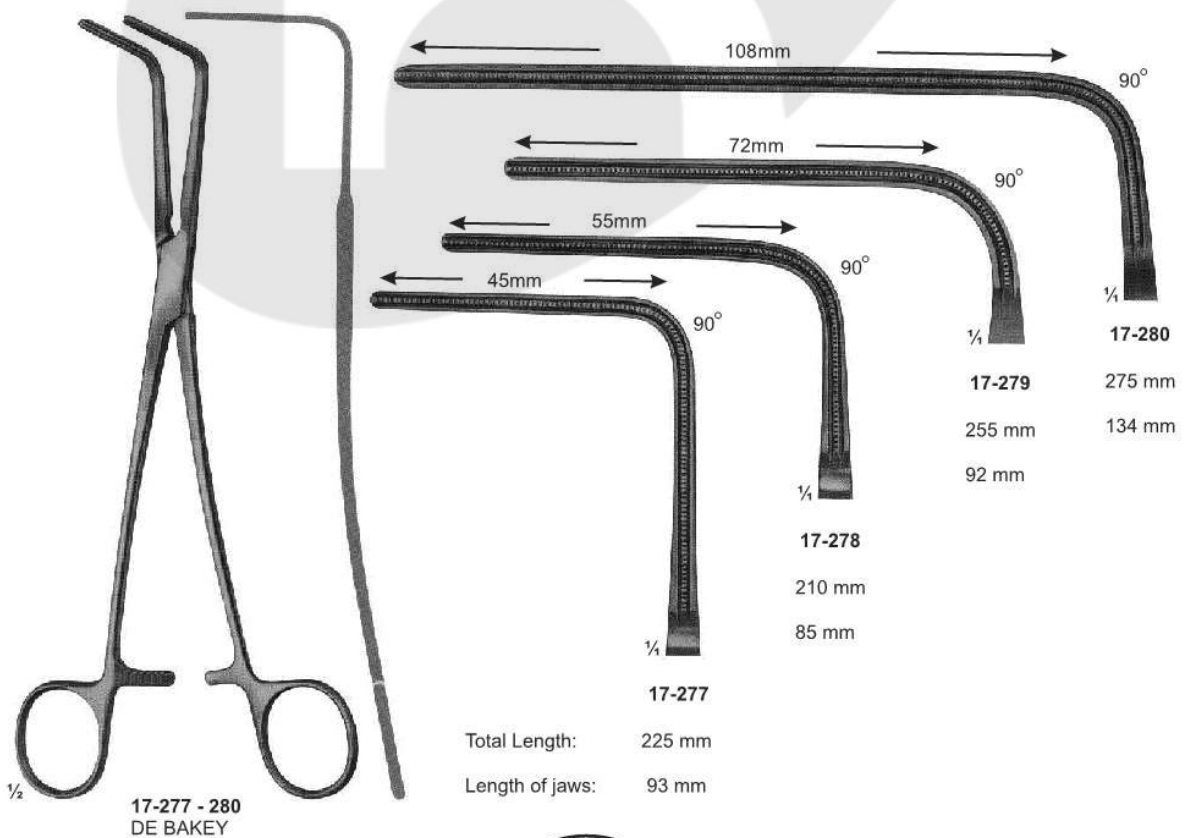
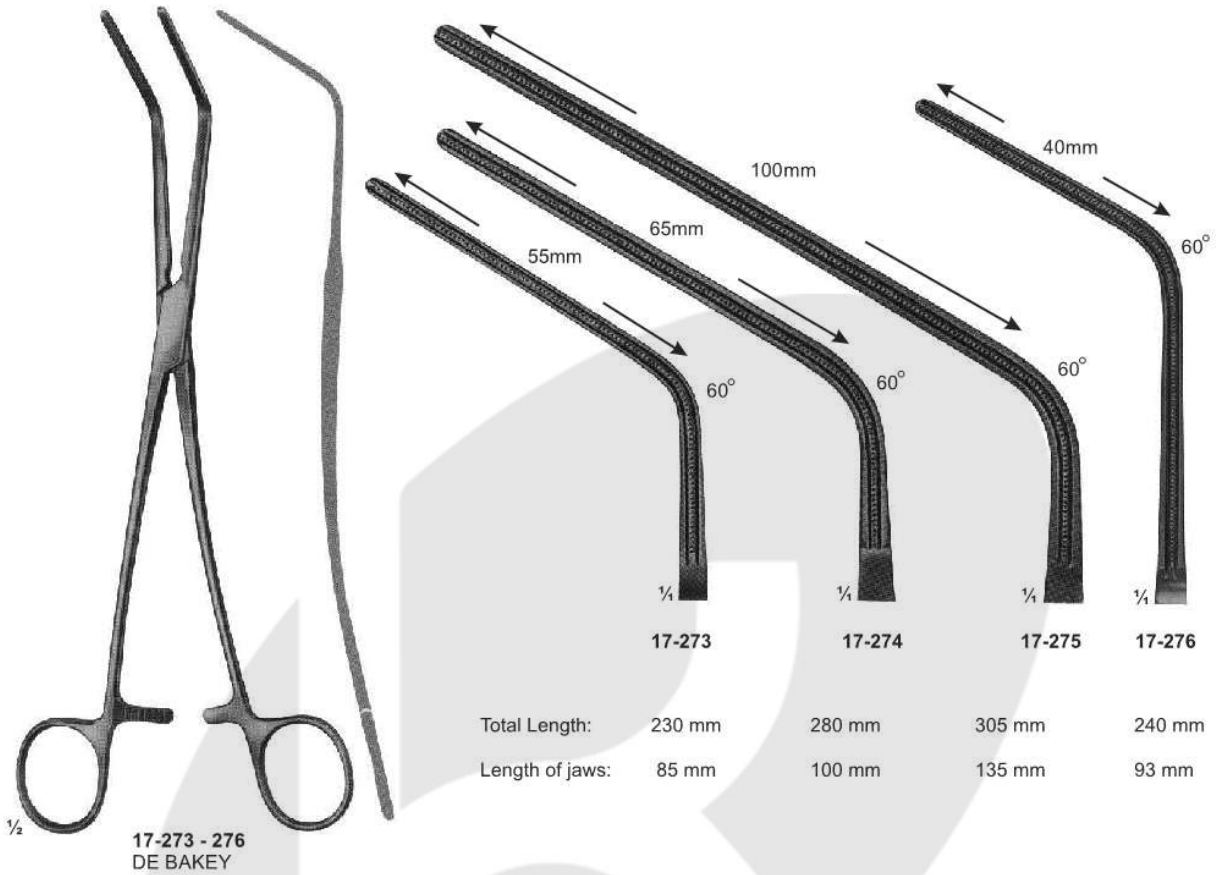

Aorta-Anastomosis Clamps

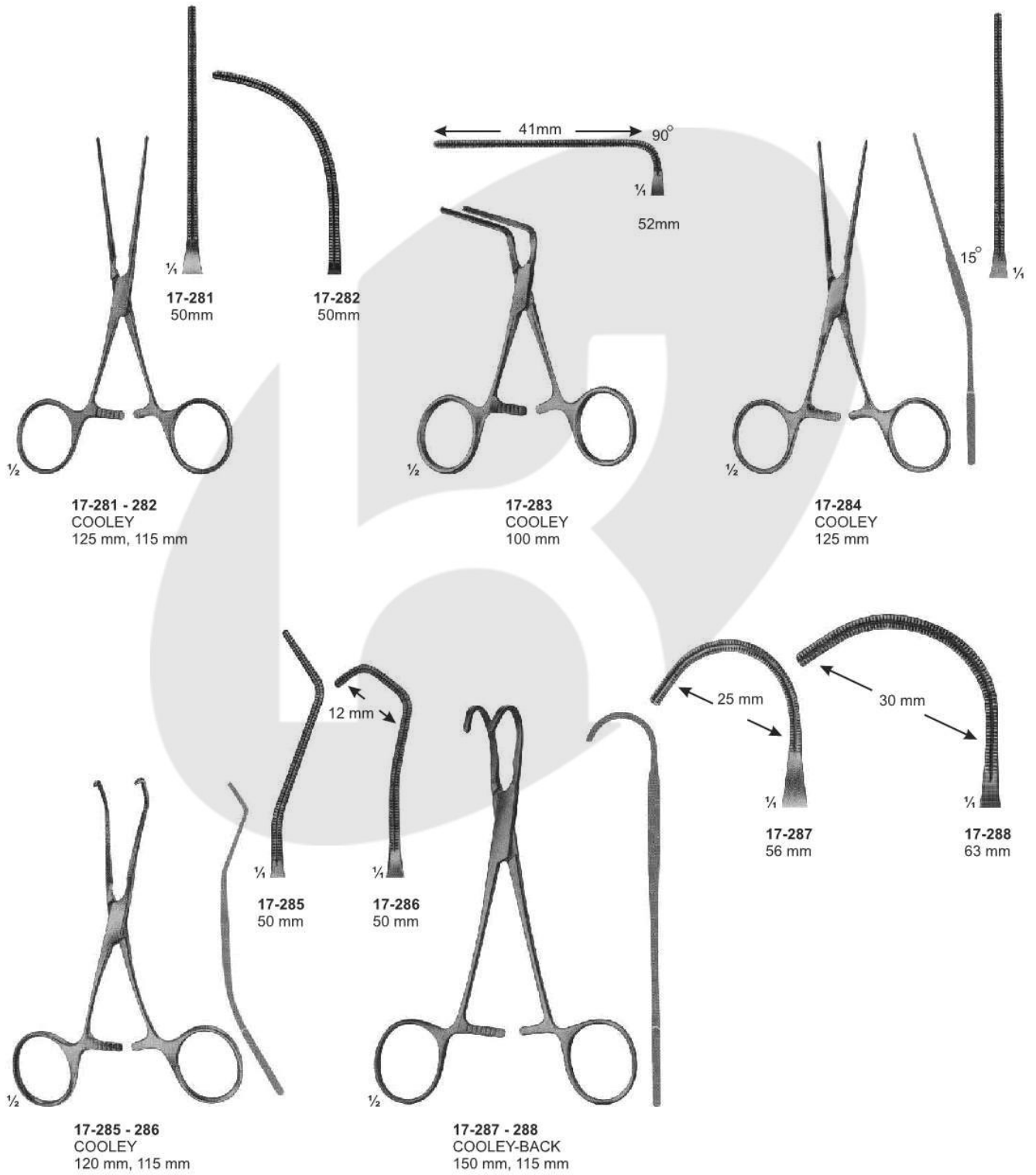

Aorta-Anastomosis Clamps

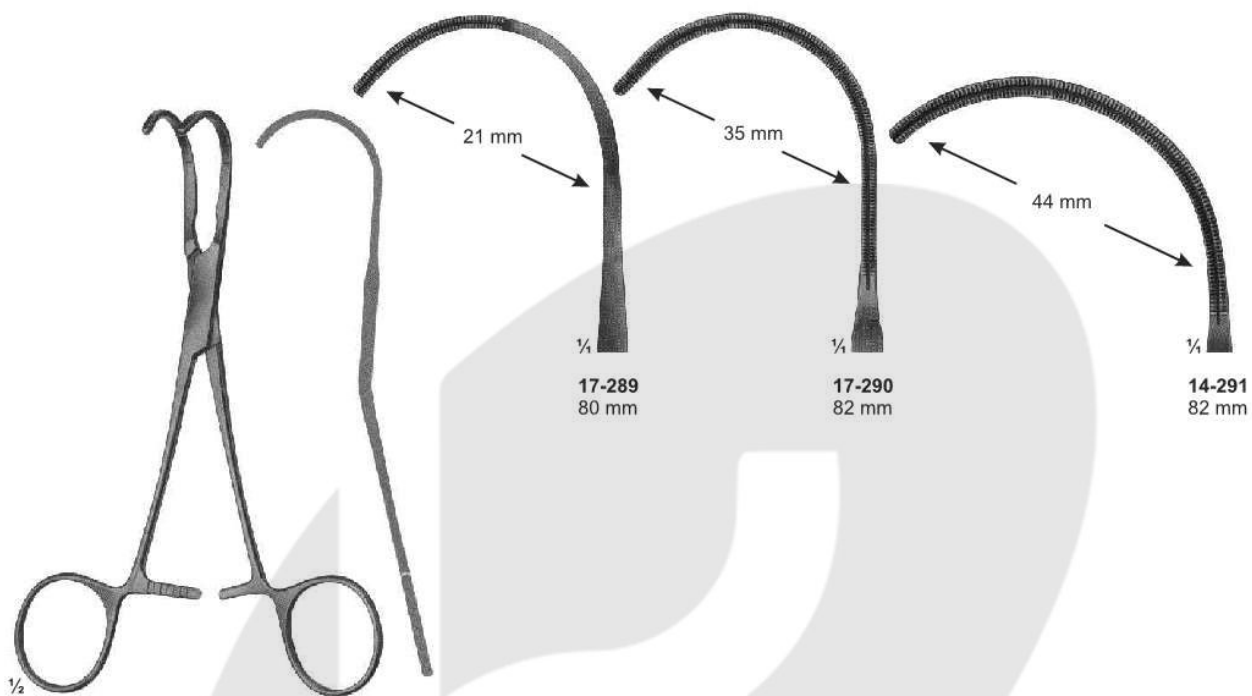

17-289 - 291
COOLEY
170 mm

17-289
80 mm

17-290
82 mm

14-291
82 mm

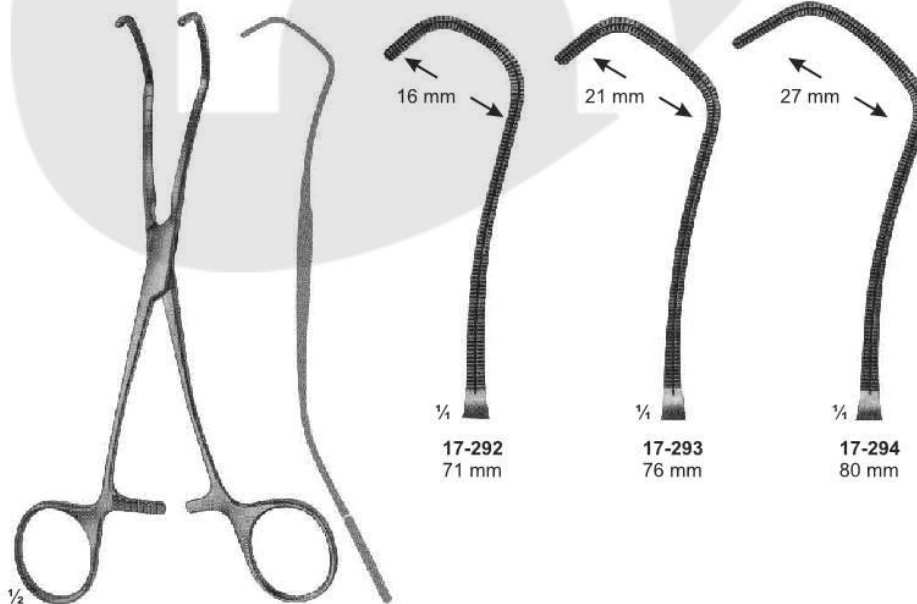

17-292 - 294
DERRA-COOLEY
170 mm, 175 mm, 175mm

17-292
71 mm

17-293
76 mm

17-294
80 mm

Aorta-Anastomosis Clamps

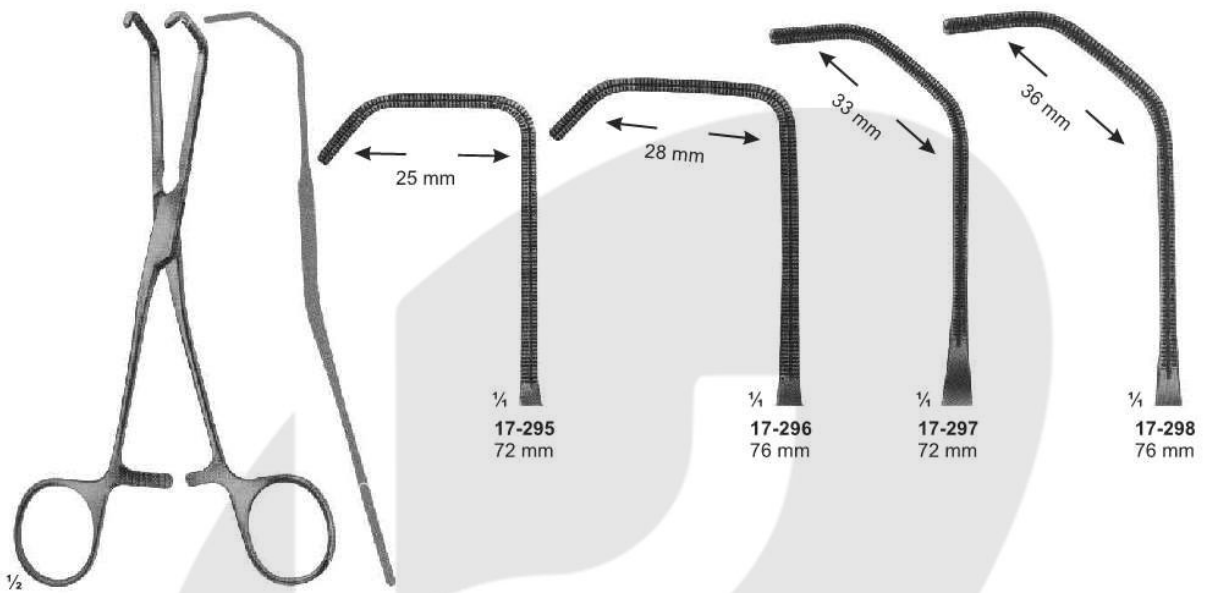

17-295 - 298
COOLEY
165 mm, 165 mm
175 mm, 180 mm

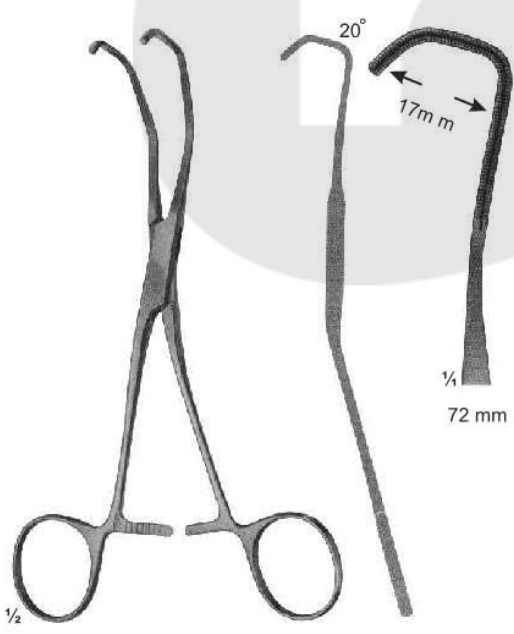

17-299
COOLEY
170 mm

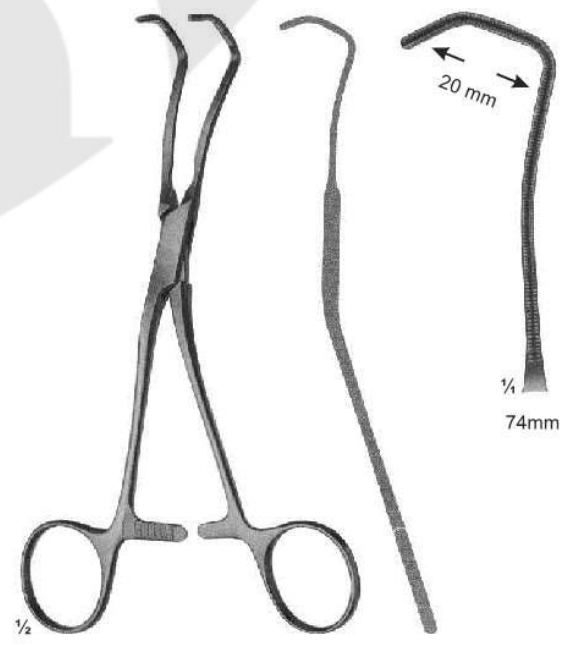

17-300
COOLEY
175 mm

Aorta-Anastomosis Clamps

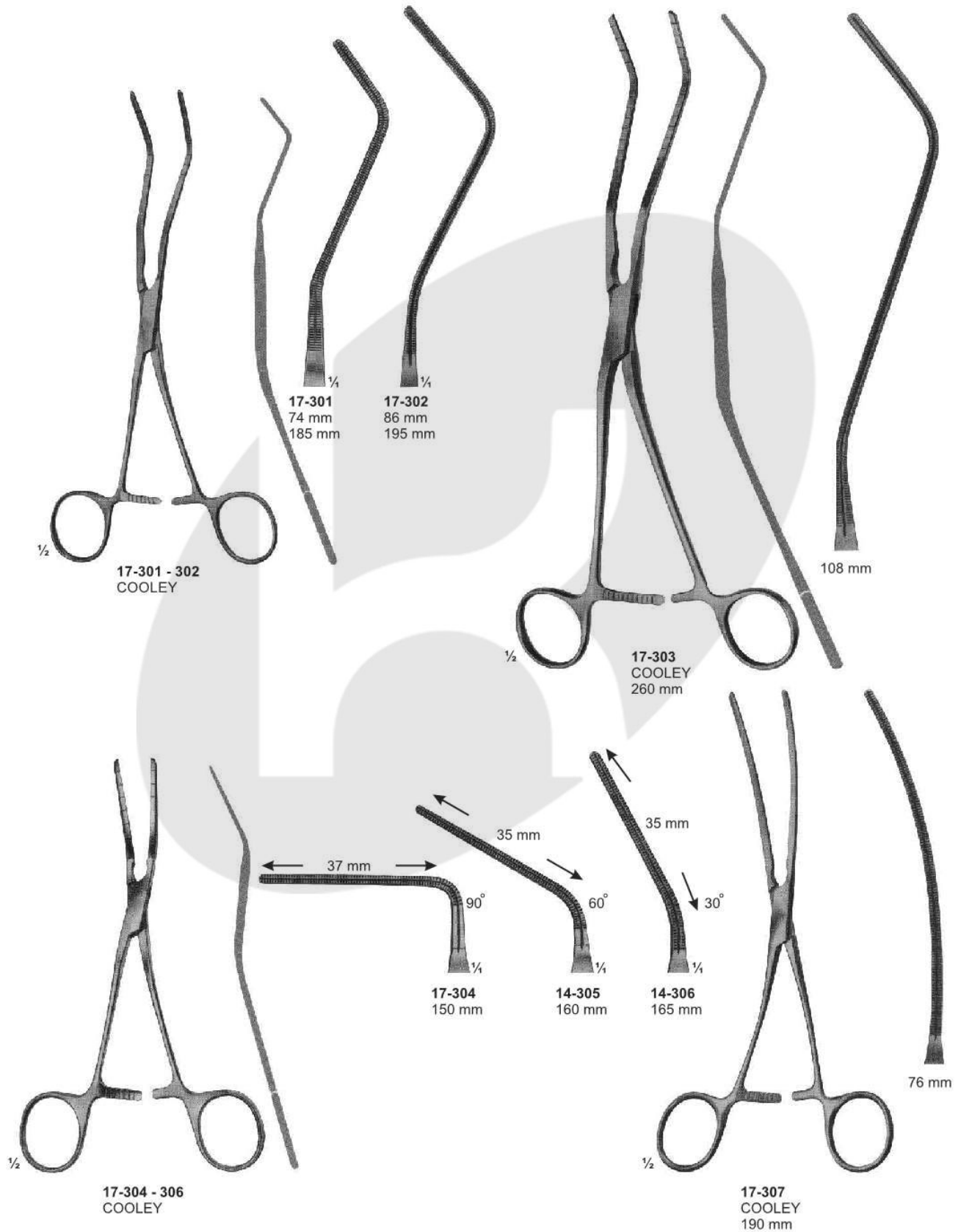

Aorta-Anastomosis Clamps

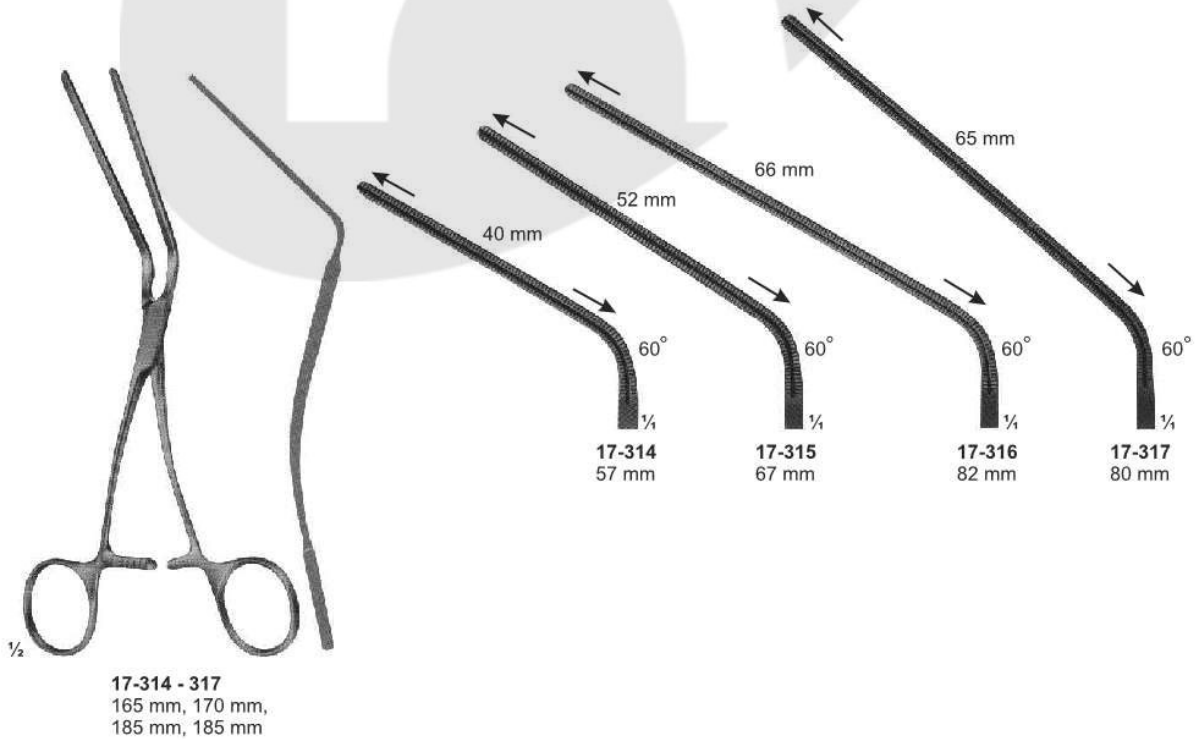
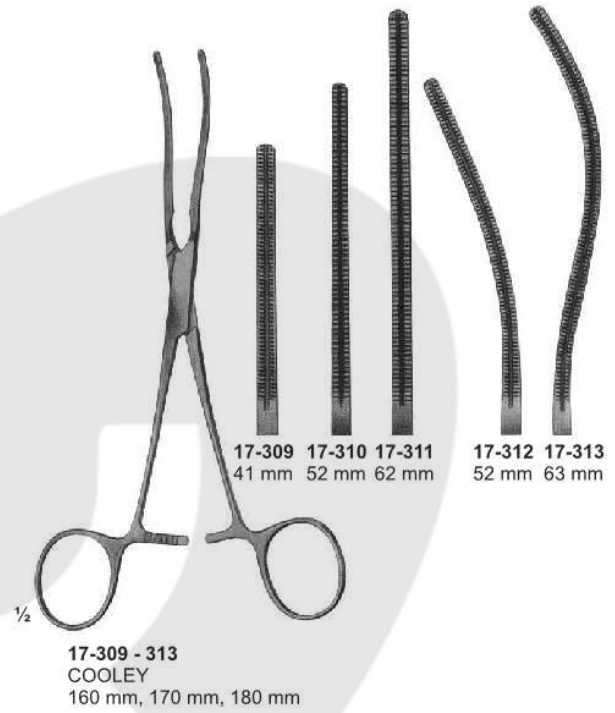
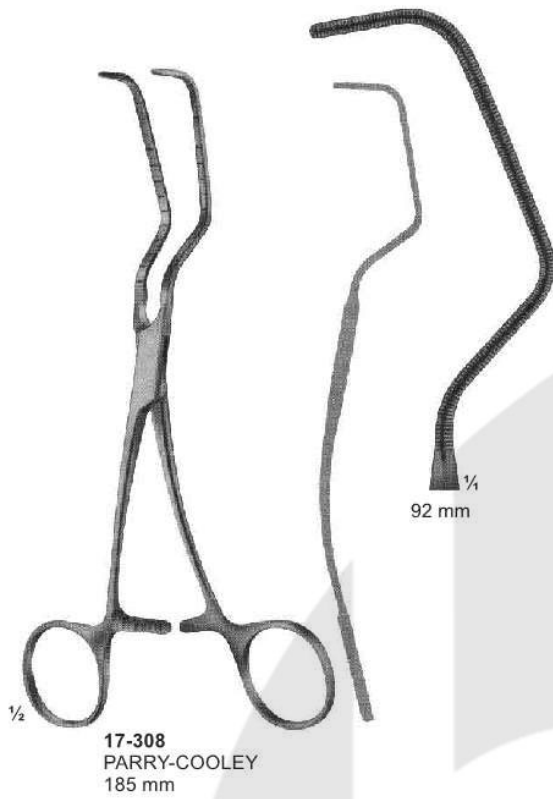

Multi-Purpose Clamps

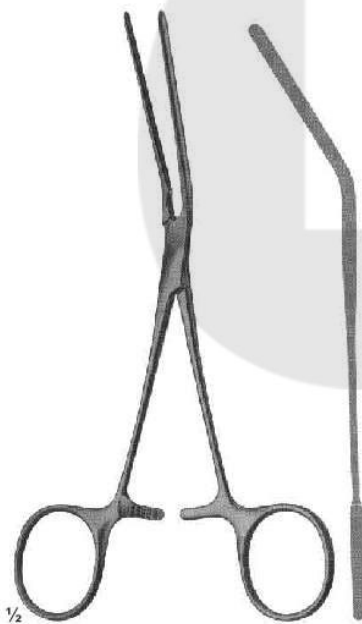

DARDIK

17-318	150 mm	17-323	170 mm
17-319	150 mm	17-324	170 mm
17-320	150 mm	17-325	170 mm
17-321	145 mm	17-326	160 mm
17-322	130 mm	17-327	135 mm

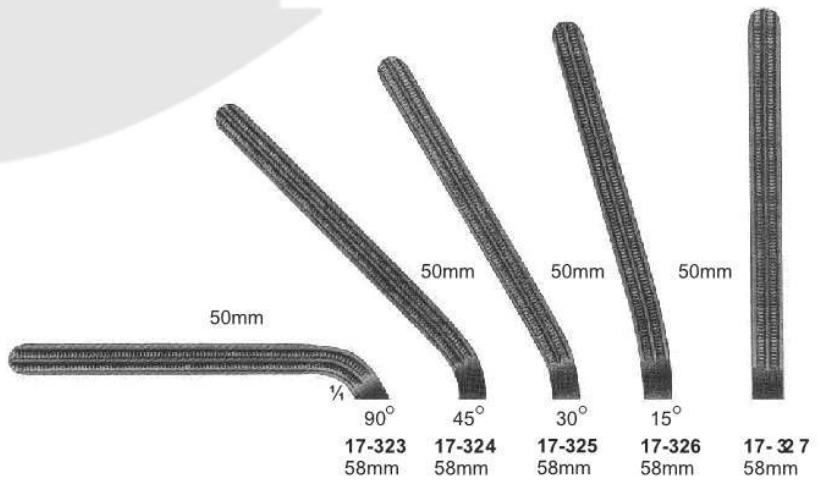
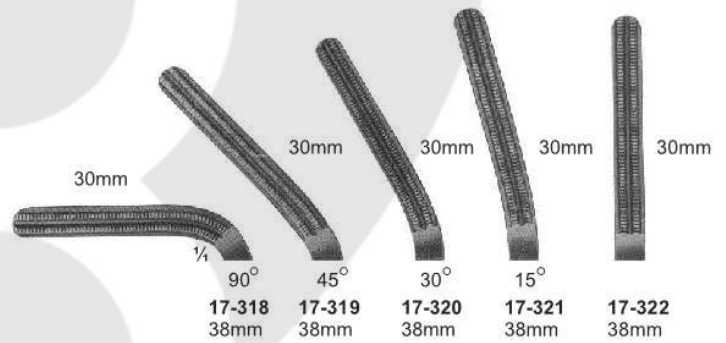

Multi-Purpose Clamps

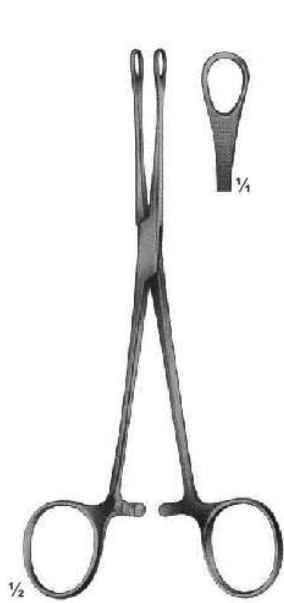

17-328
WILLIAMS
160 mm



17-329
TUTTLE
230 mm

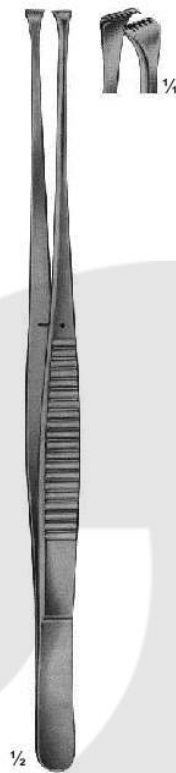

17-330
NELSON
230 mm

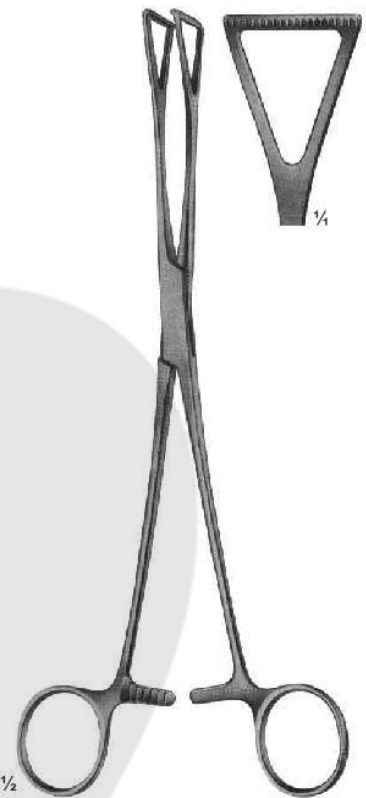

17-331
DUVAL
230 mm

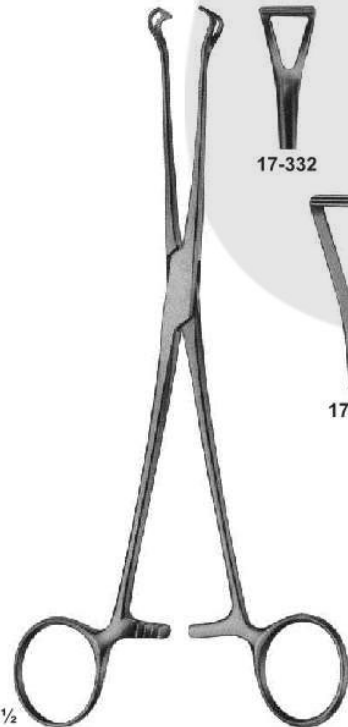

BABCOCK
17-332 170 mm
17-333 215 mm
17-334 220 mm

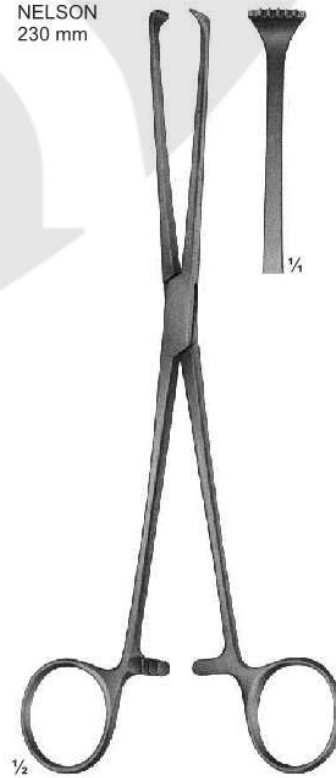

17-335
ALLIS
220 mm

Multi-Purpose Clamps



17-336
FINOCHIETTO
245 mm



17-337 - 338
SEMB
244 mm

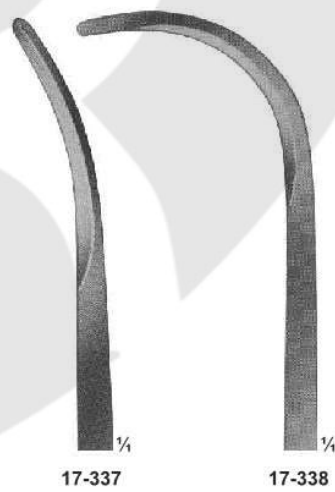

17-338

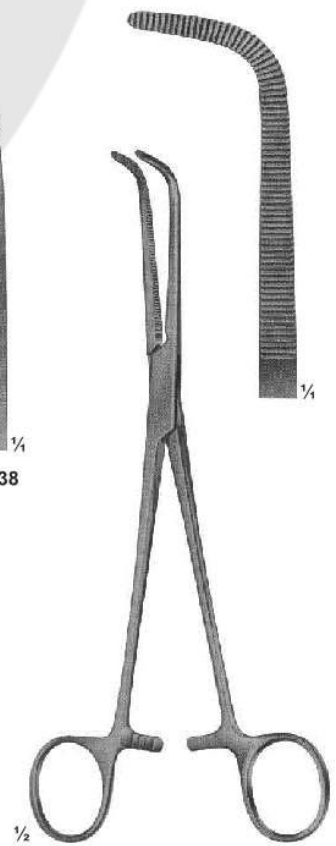

17-339
WIKSTROEM
205 mm

Multi-Purpose Clamps

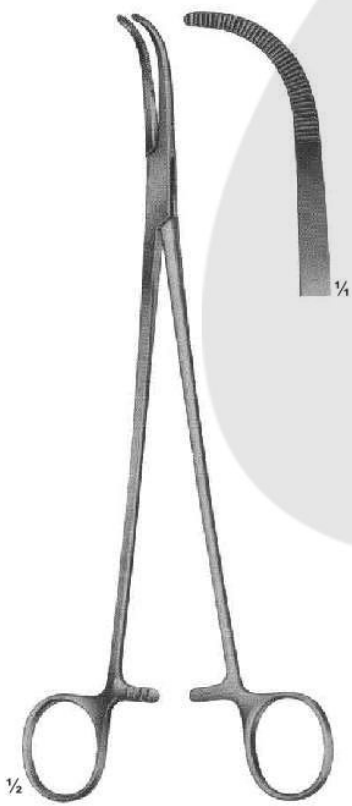

17-340
MIXTER
230 mm

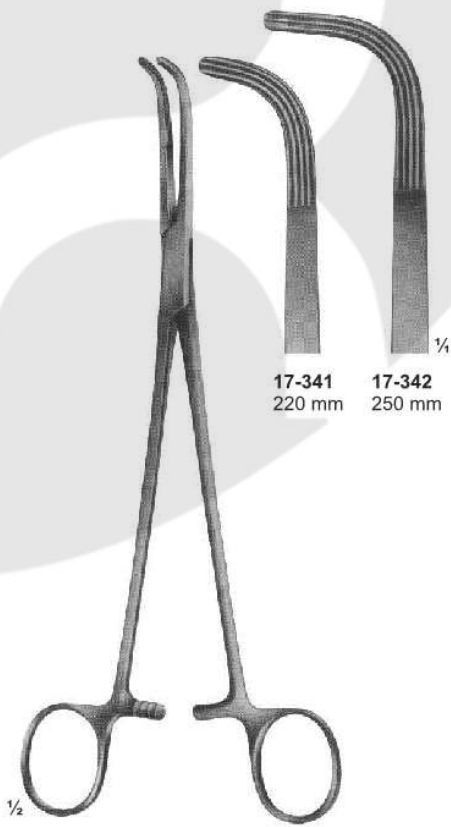

17-341 220 mm
17-342 250 mm

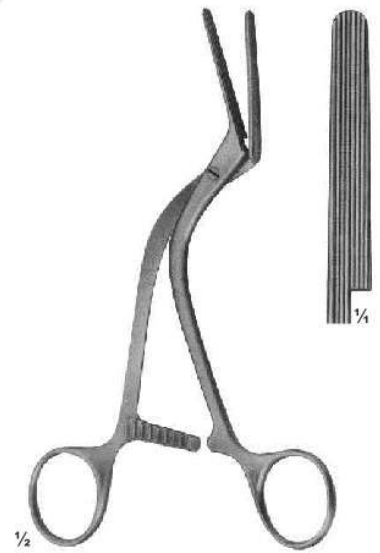

17-343
HOPFNER
160 mm

Multi-Purpose Clamps

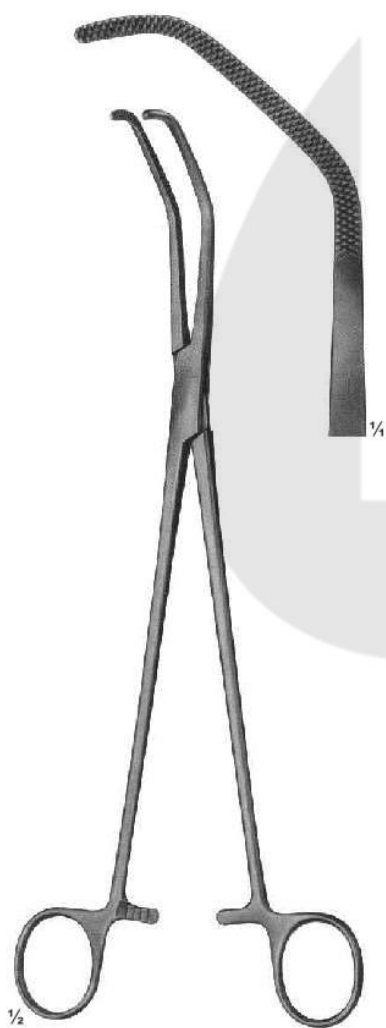

17-344
SATINSKY
265 mm



17-345
SATINSKY
265 mm

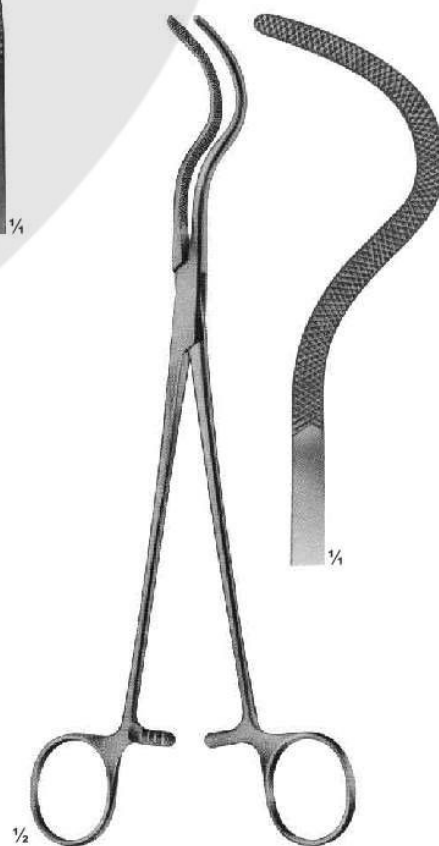

17-346
HARKEN
240 mm

Multi-Purpose Clamps



17-347
PERTUISET
Carotid Clamp
90 mm

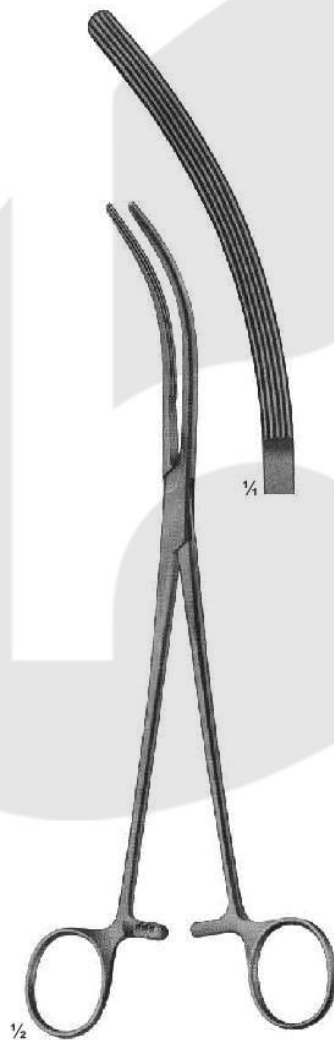

17-348
CRAFOORD-SELLORS
240 mm

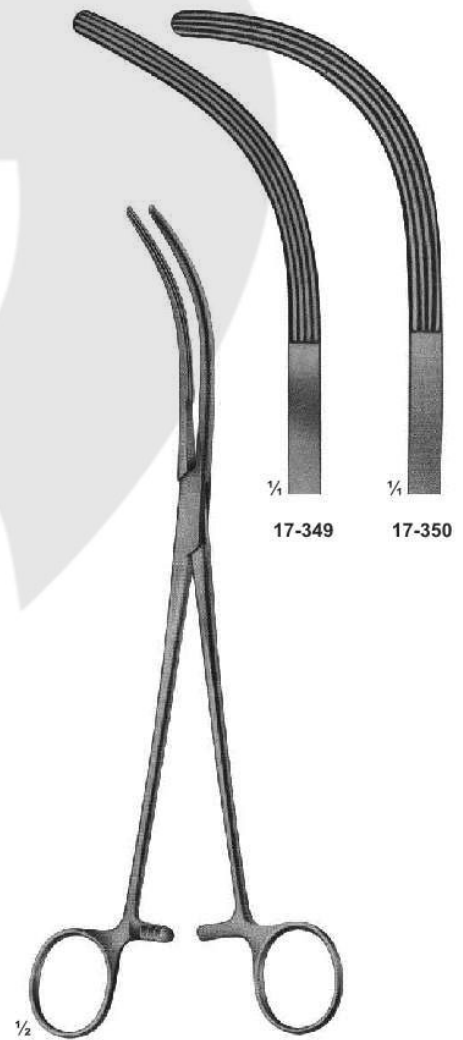

17-349 - 350
CRAFOORD
240 mm

Multi-Purpose Clamps



17-351
PRICE THOMAS
225 mm

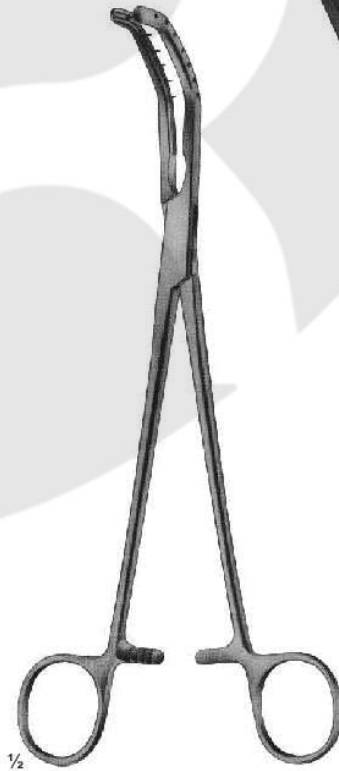

17-352 - 353
PRICE THOMAS
225 mm

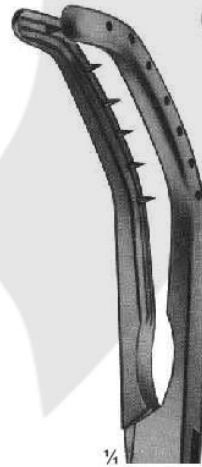

17-352
jaws with pins



17-353
jaws with pins

Rib Shears



17-354
SCHUMACHER
Sternum shears
210 mm

1/2



17-355
LEBSCHKE
Sternum chisel
200 mm

1/2



17-356
230 mm

1/4



17-357
COLLIN
195 mm

1/4

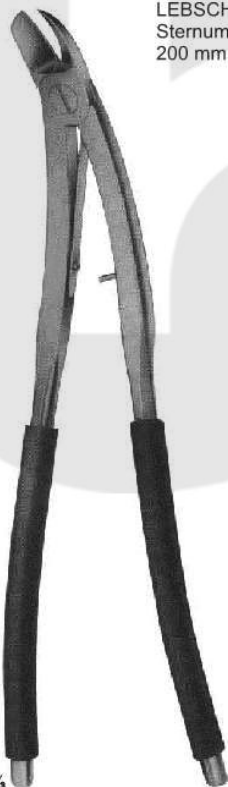

17-359
GLUCK
190 mm

1/4



17-360
BRUNNER
Universal Pattern
340 mm

1/4



17-358
GLUCK
190 mm

1/4



17-361
GIERTZ-STILLE
250 mm

1/4

Rib Holding Forceps, Bone Cutting Forceps

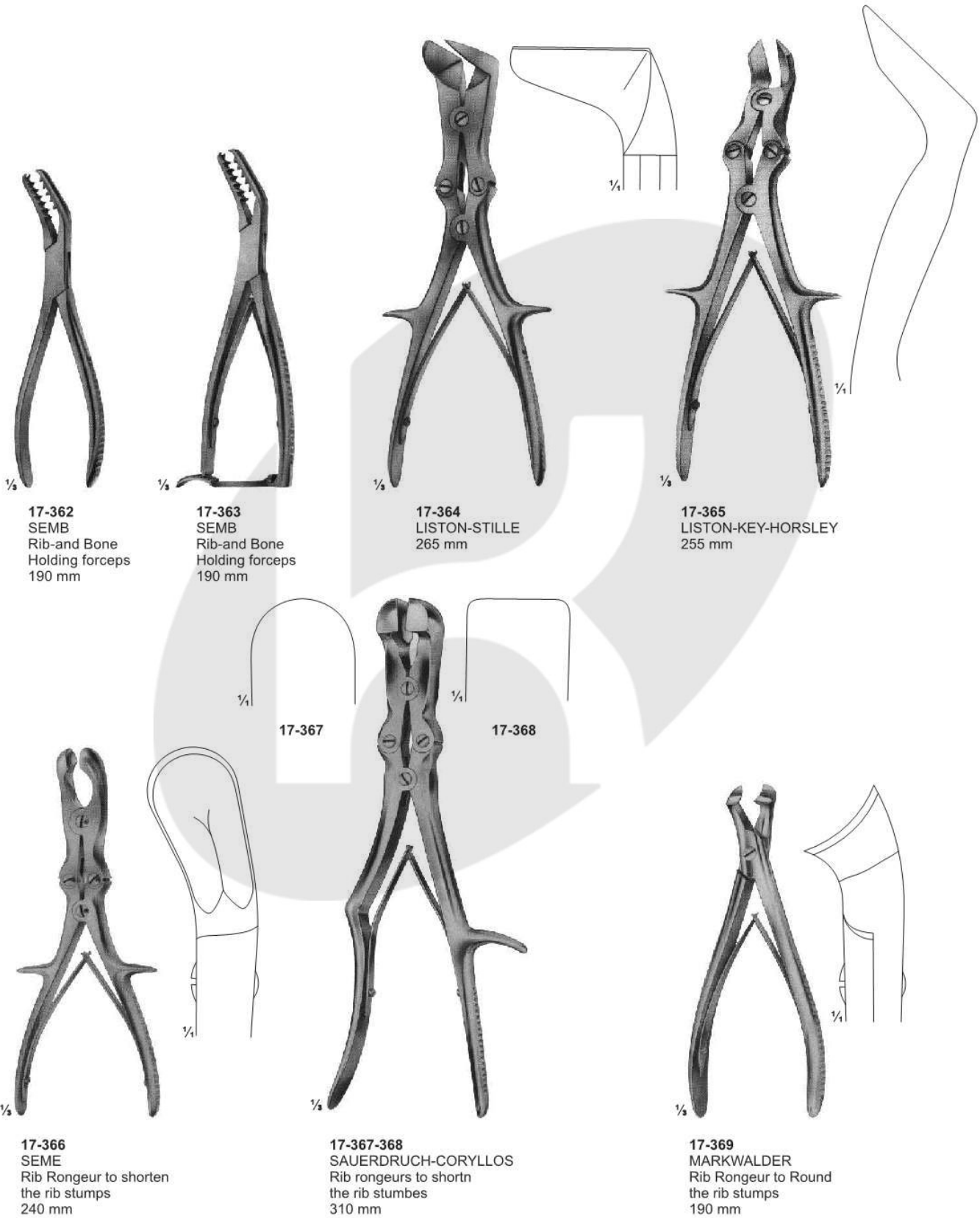

Rib Raspatories



Rib Raspatories

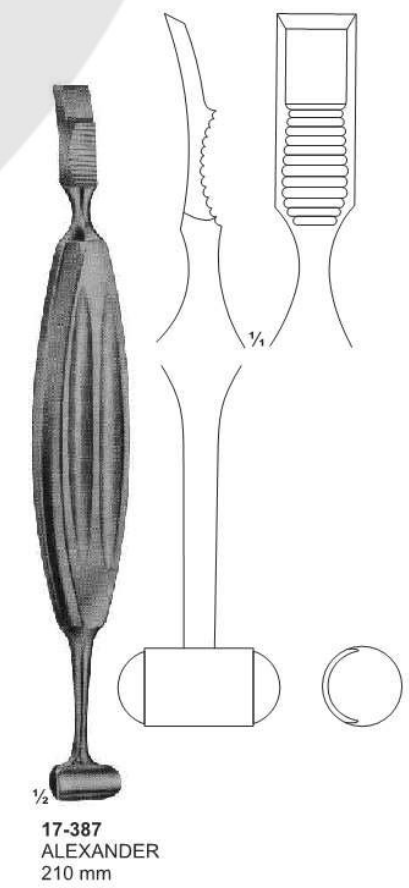
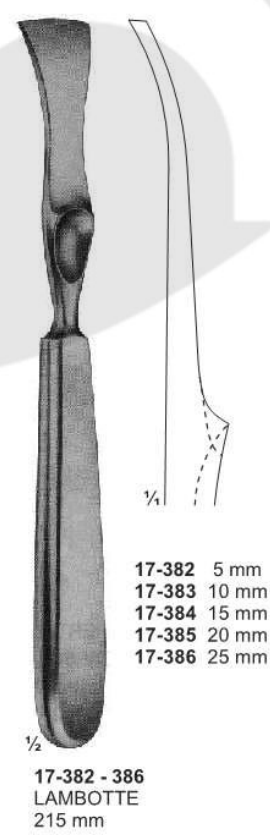
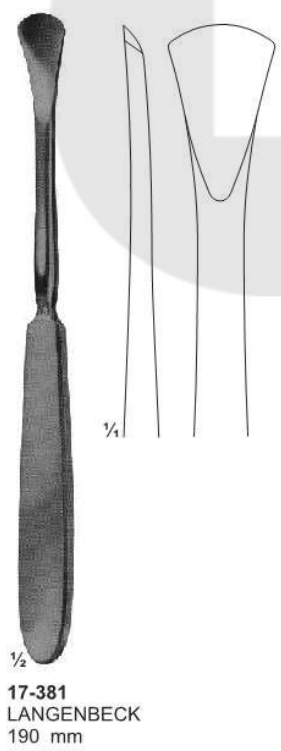
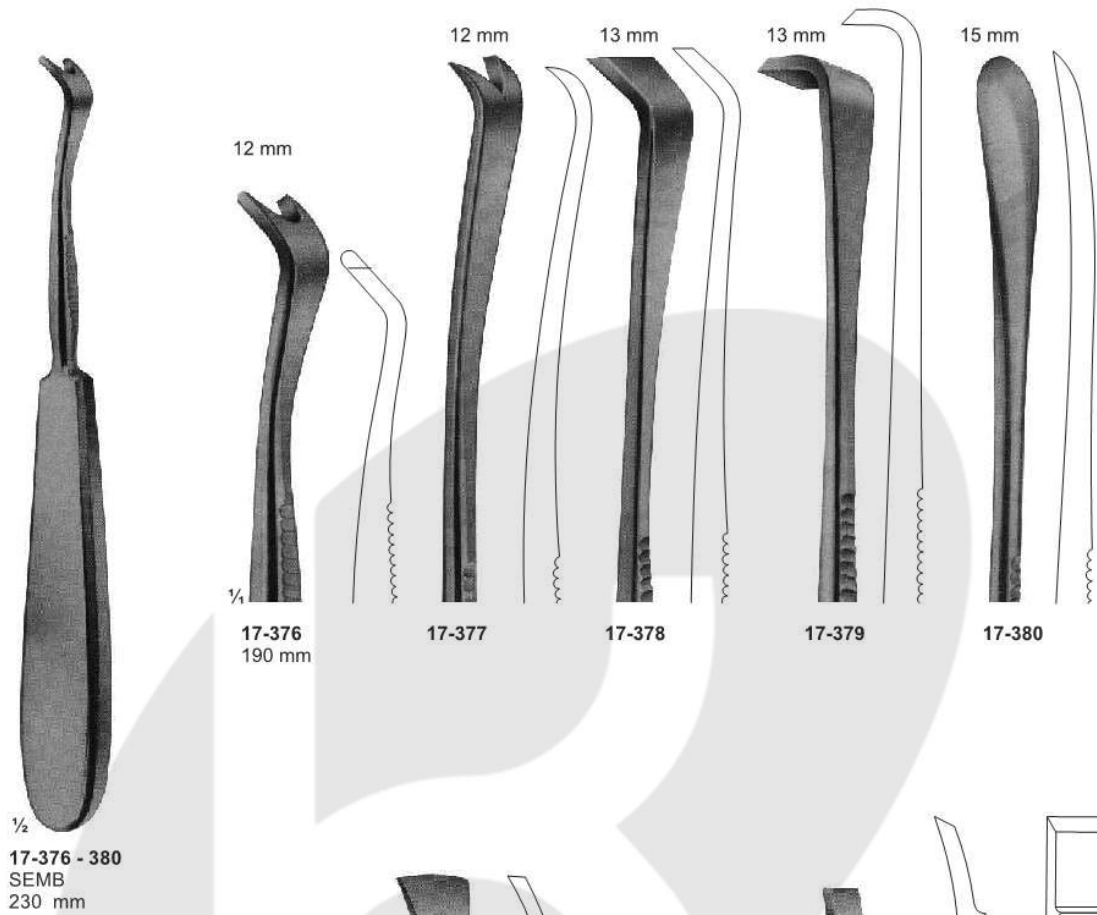

Rib Spreaders

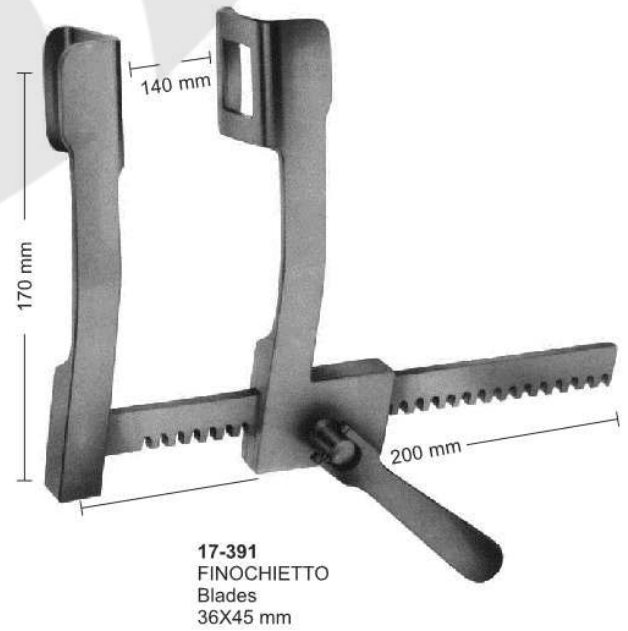
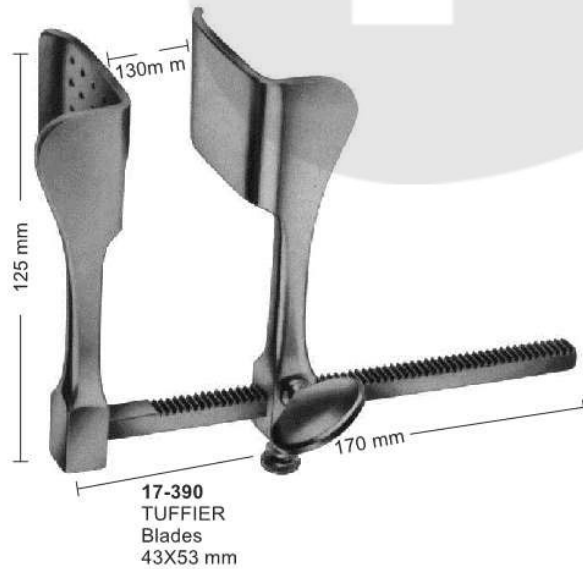
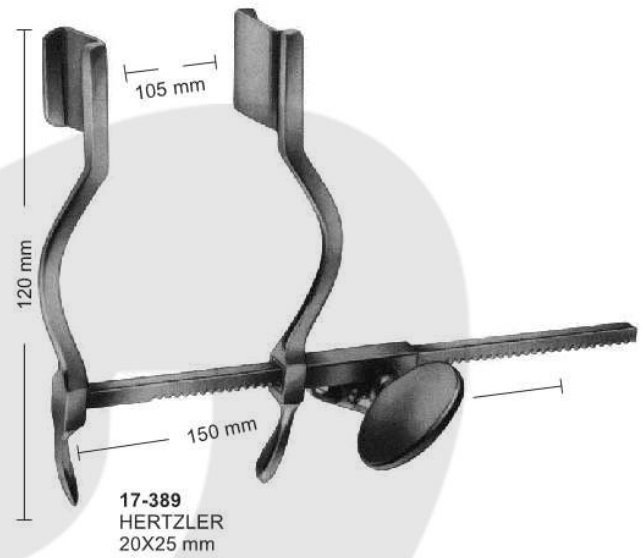
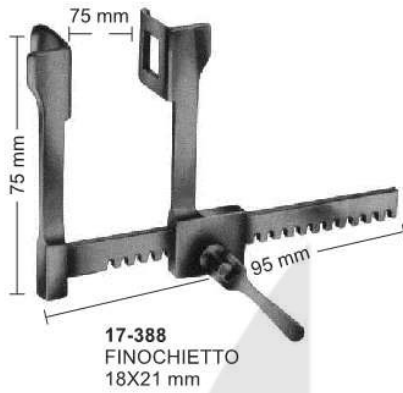

Rib Spreaders

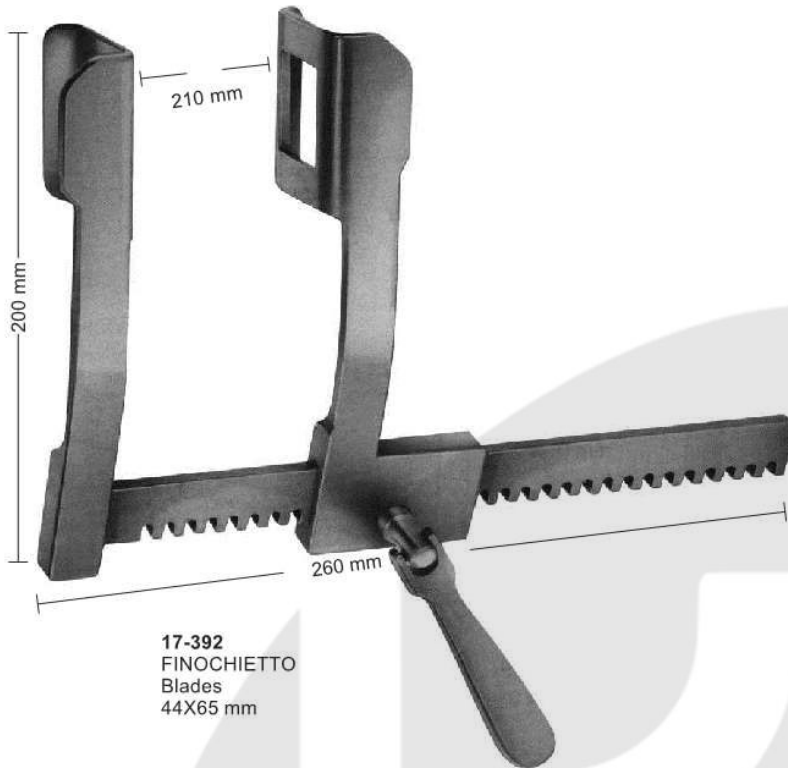

17-392
FINOCHIETTO
Blades
44X65 mm

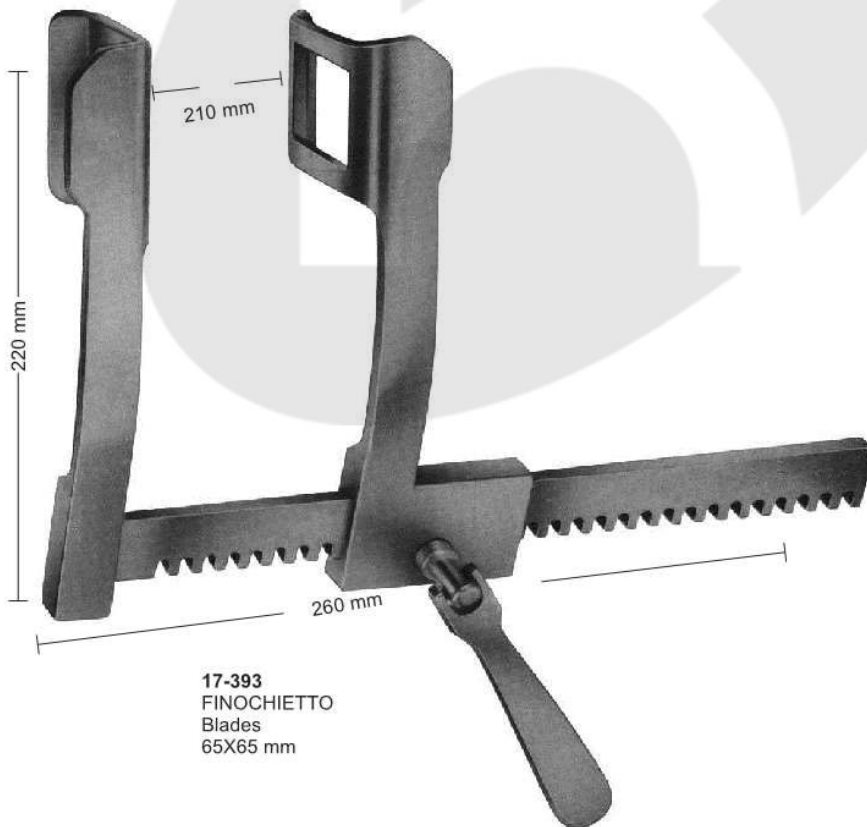

17-393
FINOCHIETTO
Blades
65X65 mm

Rib Spreaders

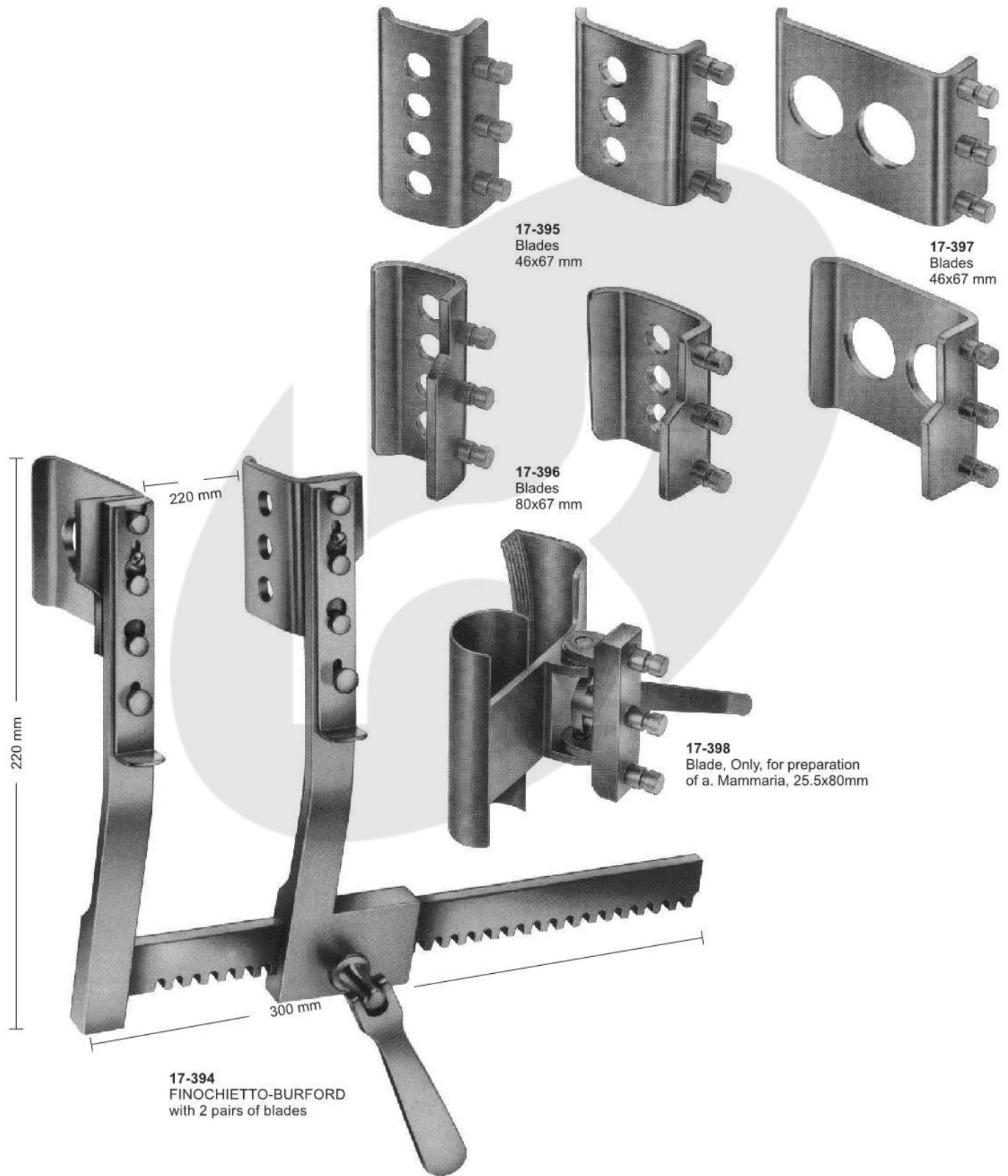

Rib Spreaders

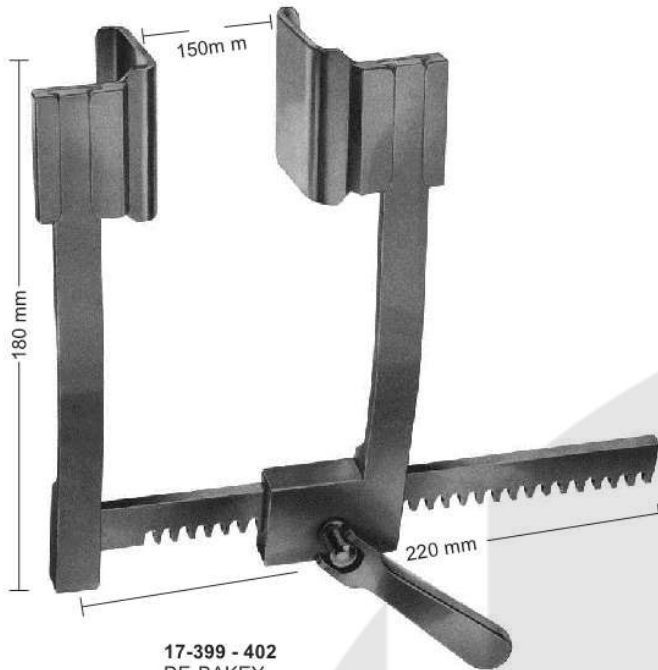

17-399 - 402
DE-BAKEY
with 3 pairs of blades

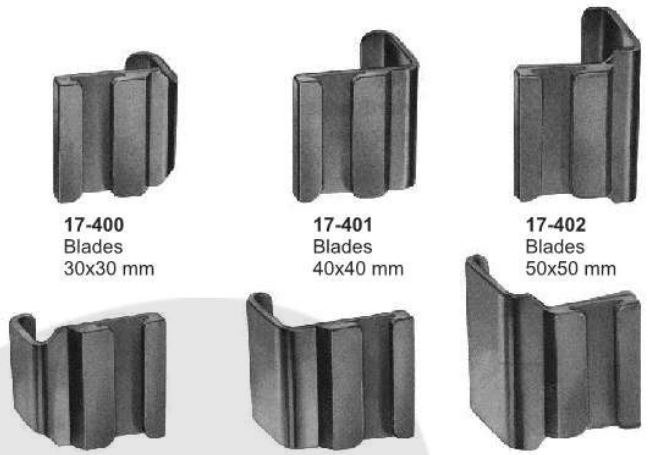

17-400
Blades
30x30 mm

17-401
Blades
40x40 mm

17-402
Blades
50x50 mm

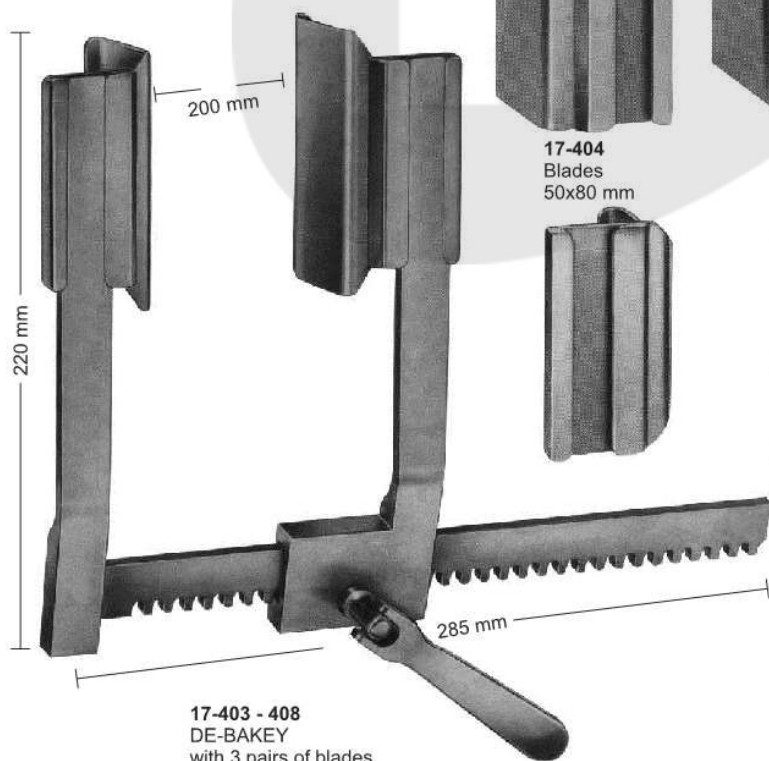

17-403 - 408
DE-BAKEY
with 3 pairs of blades

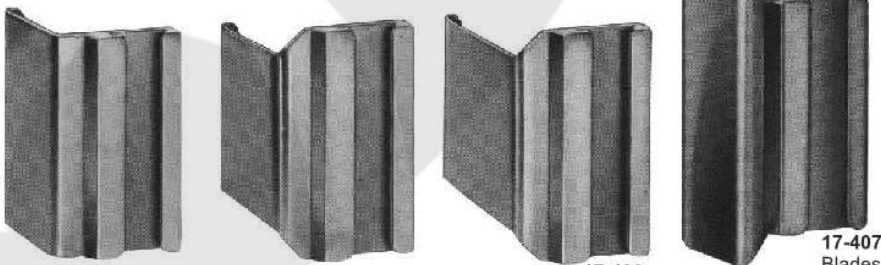

17-404
Blades
50x80 mm

17-405
Blades
80x60 mm

17-406
Blades
50x80 mm

17-407
Blades
40x100 mm

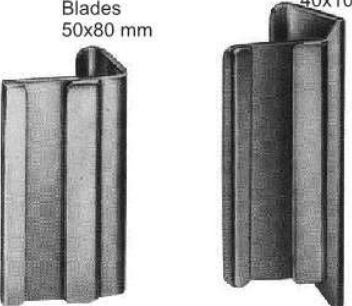

17-408
Sternotomy Blades
50x660 mm

Sternotomy Spreaders

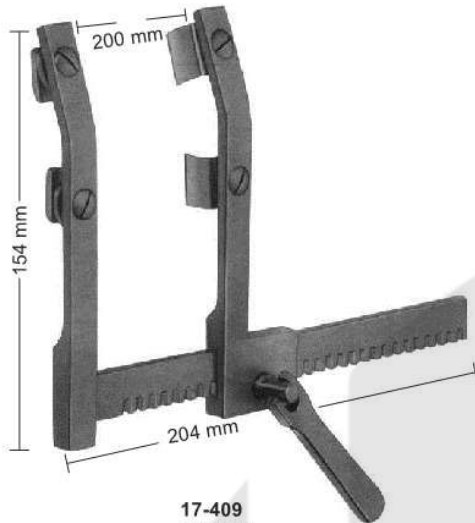

17-409
MORSE
Sternotomy spreader
for children, with moveable
double, each blade
12x20 mm

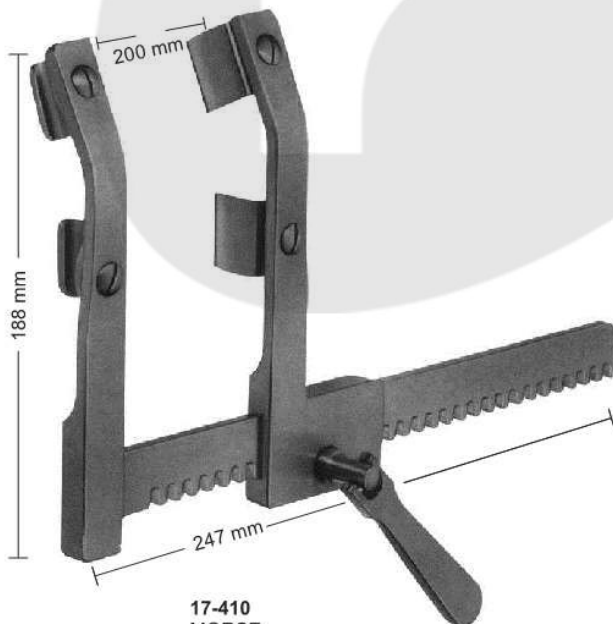

17-410
MORSE
Sternotomy spreader
for adults, with moveable
double, each blade
19x19 mm

Sternotomy- Spreaders

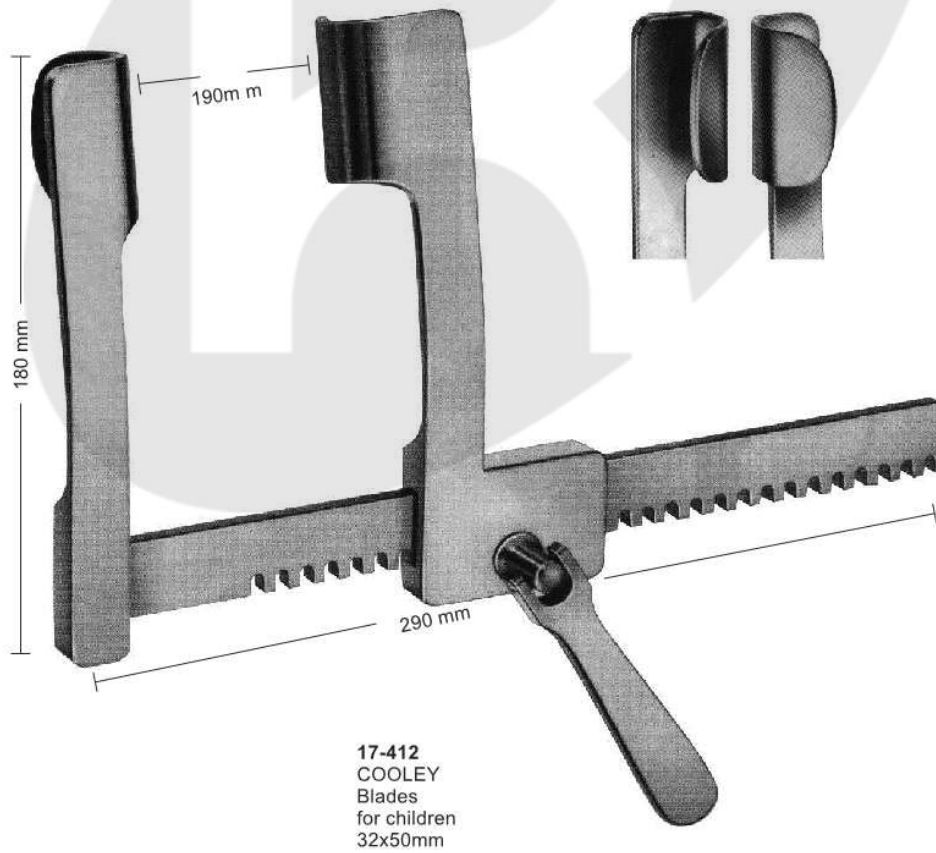
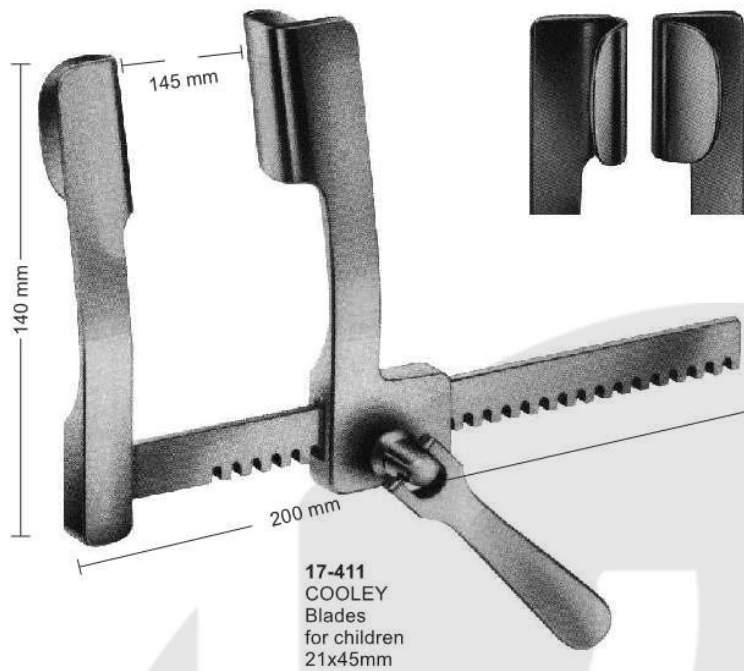

Thoracic Retractors

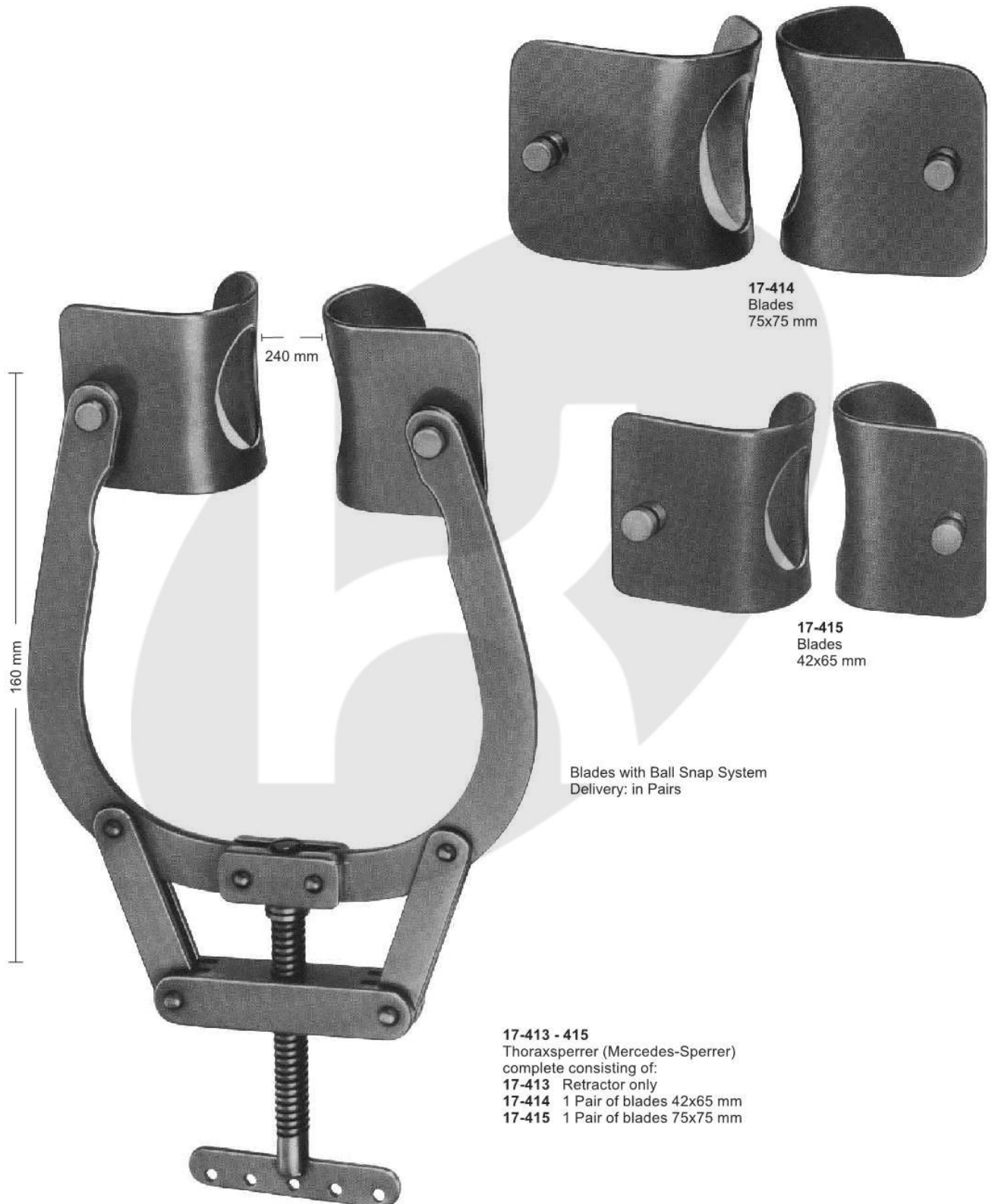

17-414
Blades
75x75 mm

17-415
Blades
42x65 mm

Blades with Ball Snap System
Delivery: in Pairs

- 17-413 - 415**
Thoraxsperrer (Mercedes-Sperrer)
complete consisting of:
17-413 Retractor only
17-414 1 Pair of blades 42x65 mm
17-415 1 Pair of blades 75x75 mm

Rib Spreaders-and Contractors



17-416
SELLORS
Rib spreader-and contractor
with swivel blades
200 mm



17-417
BAILEY
150 mm

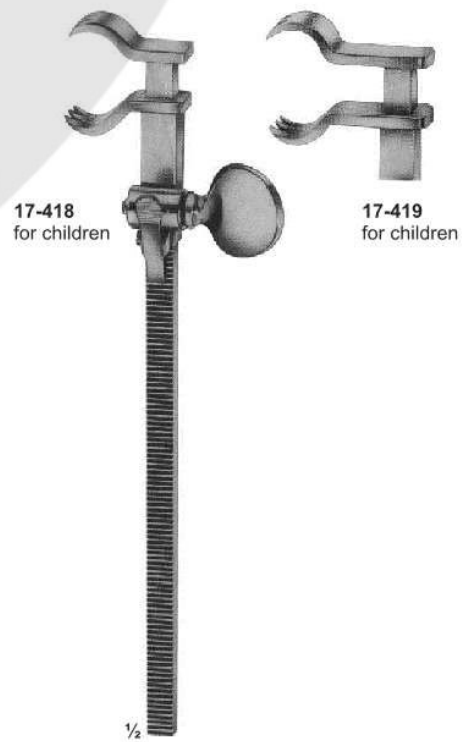

17-418
for children

17-419
for children

17-418 - 419
BAILEY
200 mm

Rib Spreaders-and Contractors

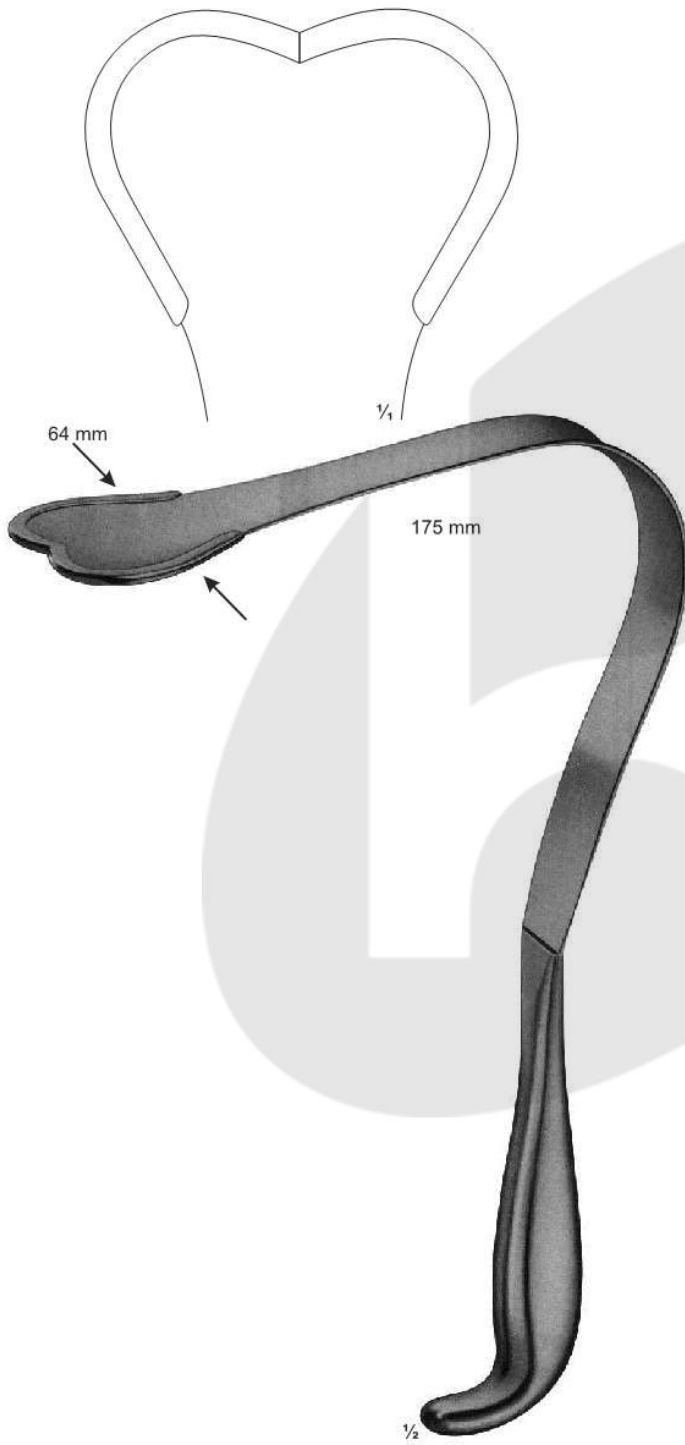

17-420
HARRINGTON-PEMBERTON
federnd/flexible
295 mm

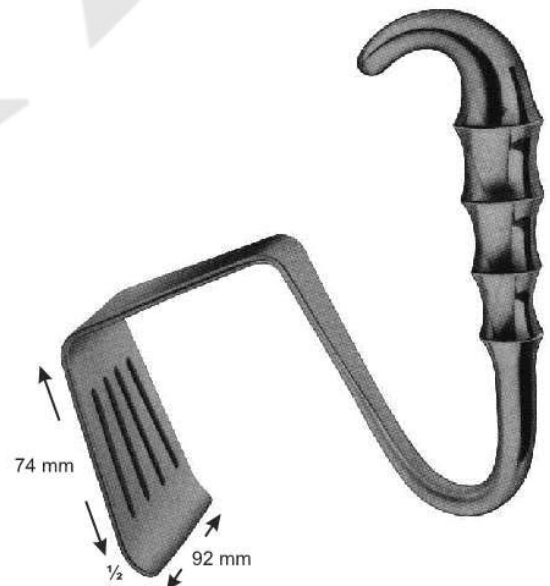

17-421
DAVIDSON
Scalpel haken

Rib Spreaders-and Contractors



17-422
ALLISON
255 mm



17-423
ALLISON
320 mm



ϕ 6-10 mm
1/2

17-424
DE BAKEY
With central bore,
3.0mm diam.
with lateral slots
275 mm



ϕ 7-9 mm
1/2

17-425
YANKAUER
With central bore,
2.0mm diam.
285 mm

Punches

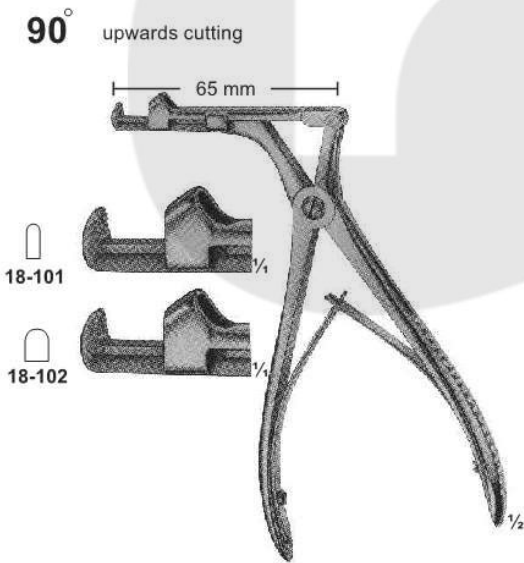
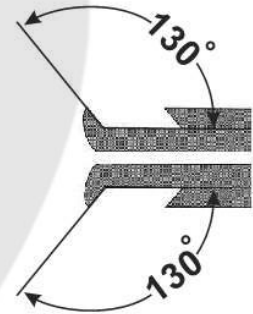
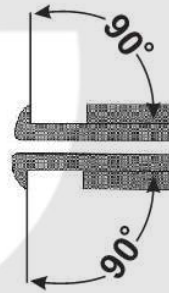
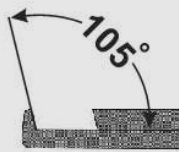

18-101 - 102
CITELLI
2 mm, 3,5 mm

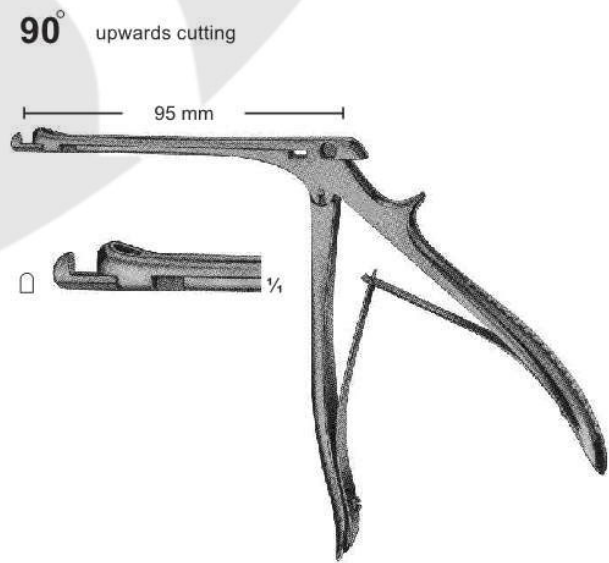

18-103
CITELLI- BEYER
1,8 mm

Punches

90° upwards cutting

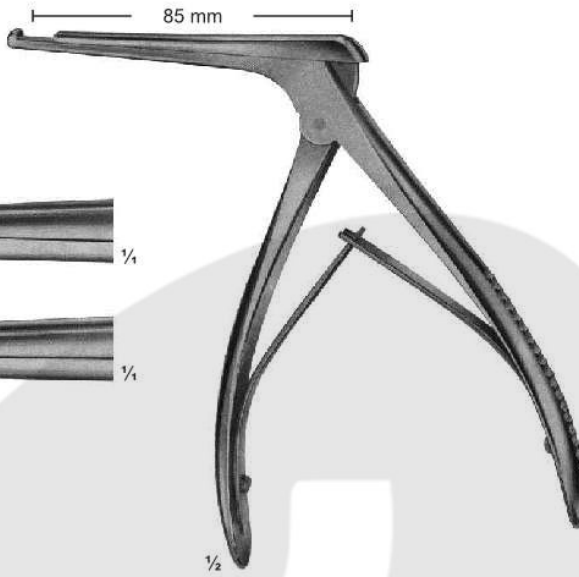

18-104 - 105
KERRISON

18-104
4 mm



18-105
5 mm



90° upwards cutting

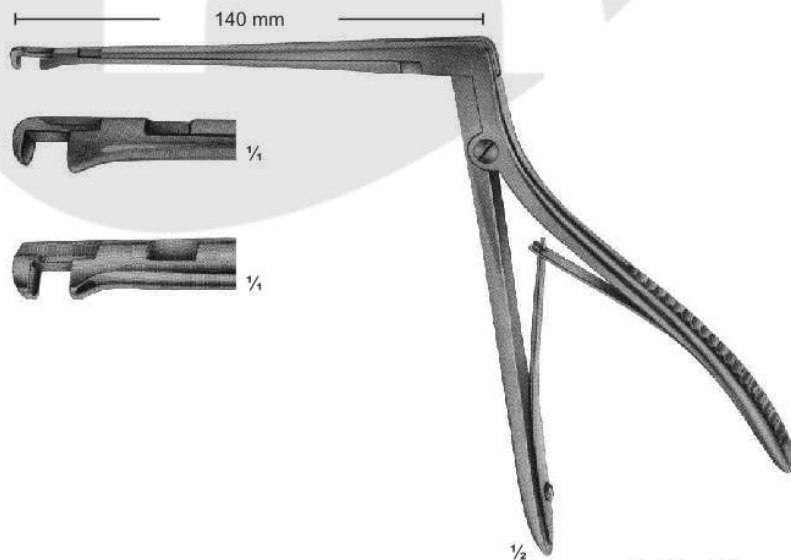

18-106 - 107
HAJEK-KOFLER

18-106
3,3 mm



18-107
4,0 mm

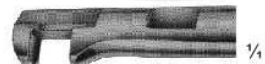

Punches

130° upwards cutting

- 18-108
1 mm 
- 18-109
2 mm 
- 18-110
3 mm 
- 18-111
4 mm 
- 18-112
5 mm 

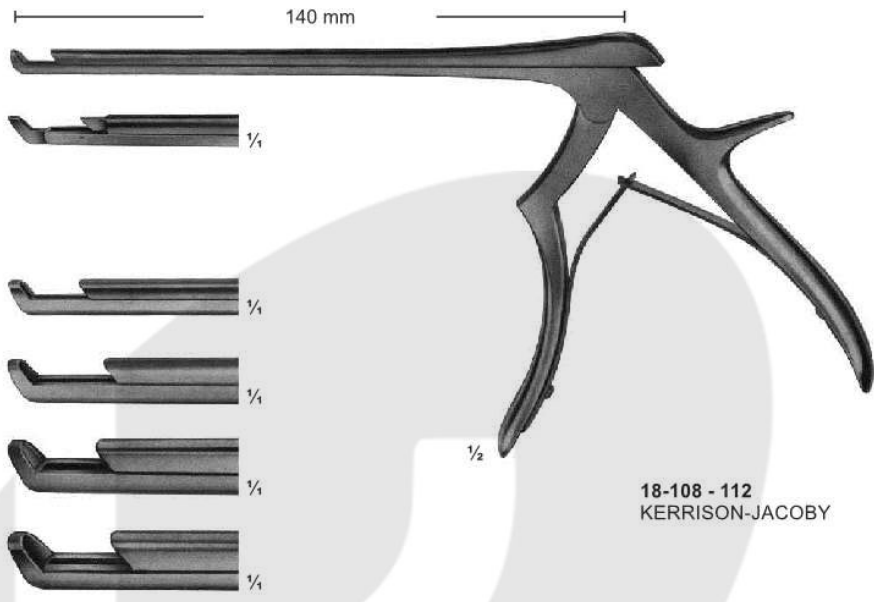



18-108 - 112
KERRISON-JACOBY

90° upwards cutting

- 18-113
1 mm 
- 18-114
2 mm 

FERRIS-SMITH-KERRISON

- 18-115
3 mm 
- 18-116
4 mm 
- 18-117
5 mm 

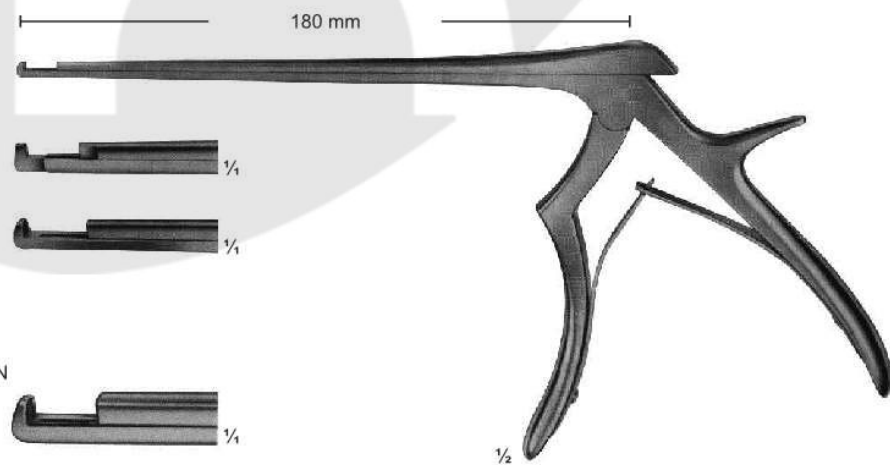

18-113 - 117
KERRISON-JACOBY

Rongeurs

Angled positions for rongeurs

- 18-118**
3,0 mm
- 18-119**
3,6 mm
- 18-120**
4,2 mm
- 18-121**
4,8 mm
- 18-122**
5,8 mm

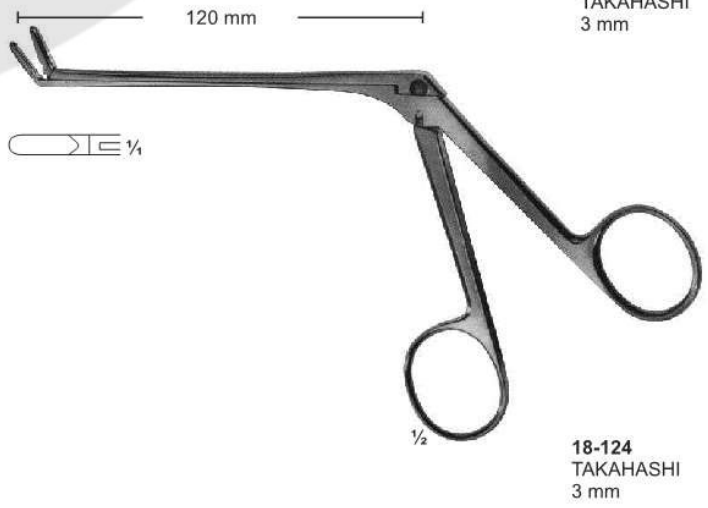
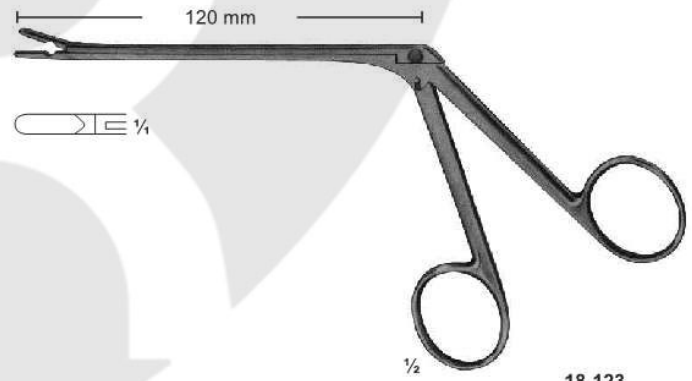
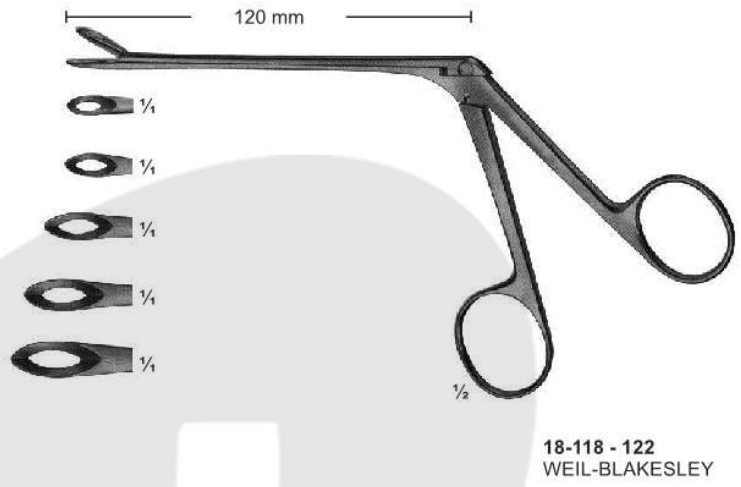

130°

Rongeurs

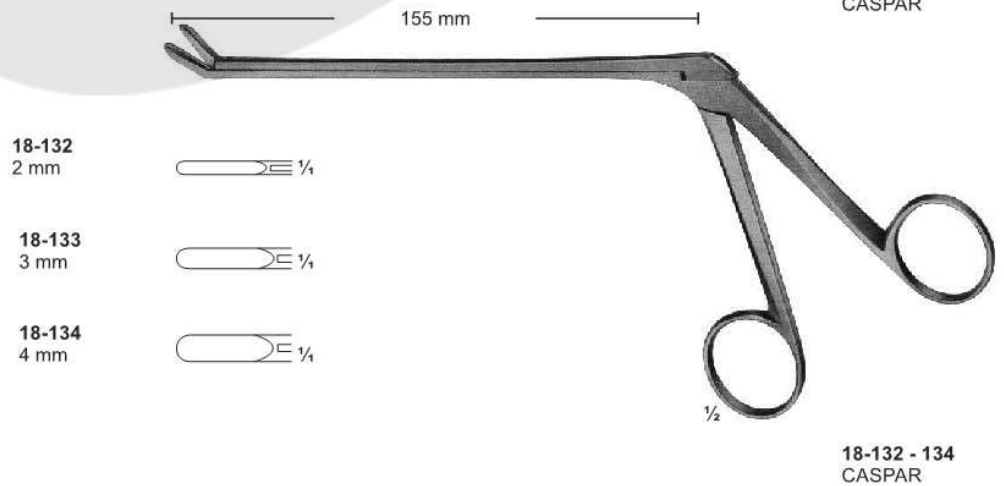
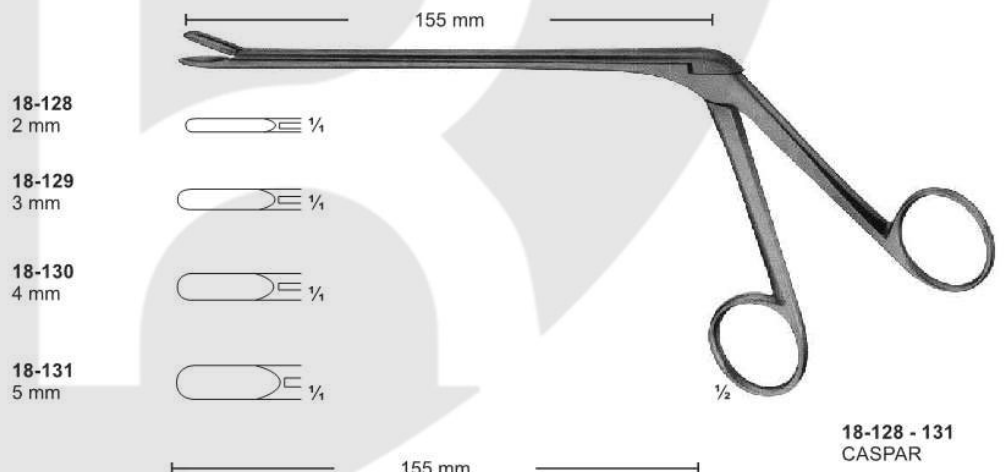
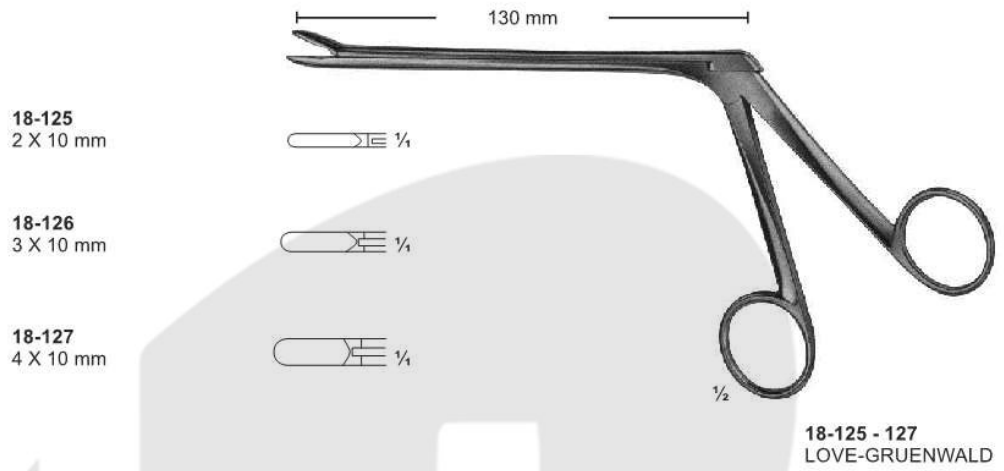

Rongeurs

155 mm

18-135
2 mm

18-136
3 mm

18-137
4 mm

18-135 - 137
CASPAR

Length of shaft 140 mm Length of shaft 160 mm Length of shaft 185 mm size of jaws

18-138 **18-143** **18-148** 2 X12 mm

18-139 **18-144** **18-149** 3 X12 mm

18-140 **18-145** **18-150** 4 X14 mm

18-141 **18-146** **18-151** 5 X14 mm

18-142 **18-147** **18-152** 6 X16 mm

18-138 - 152
CASPAR

Length of shaft 140 mm Length of shaft 160 mm Length of shaft 185 mm size of jaws

18-153 **18-156** **18-159** 3 X12 mm

18-154 **18-157** **18-160** 4 X14 mm

18-155 **18-158** **18-161** 5 X14 mm

18-153 - 161
CASPAR

Rongeurs

Length of shaft 140 mm	Length of shaft 160 mm	Length of shaft 185 mm	size of jaws
18-162	18-164	185-166	3 X12 mm
18-163	18-165	18-167	4 X14 mm

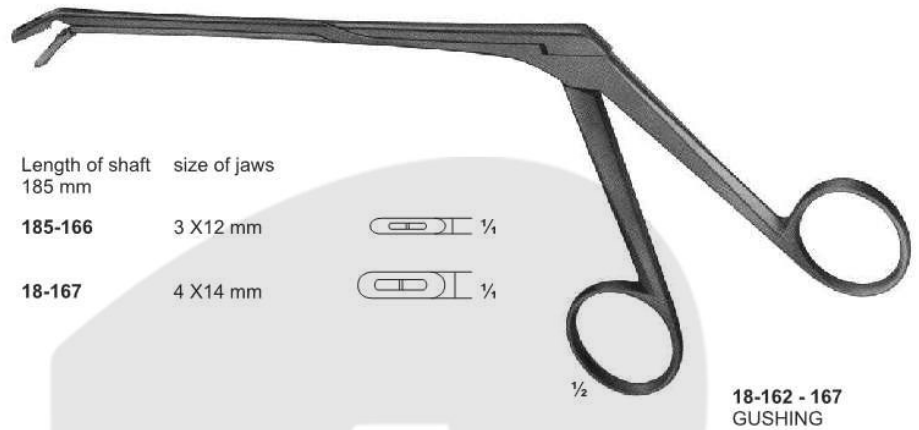

18-168
2 X 10 mm
GUSHING



18-169
3 X 10 mm
LOVE-GRUENWALD

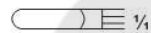

18-170
4 X 10 mm
SPURLING

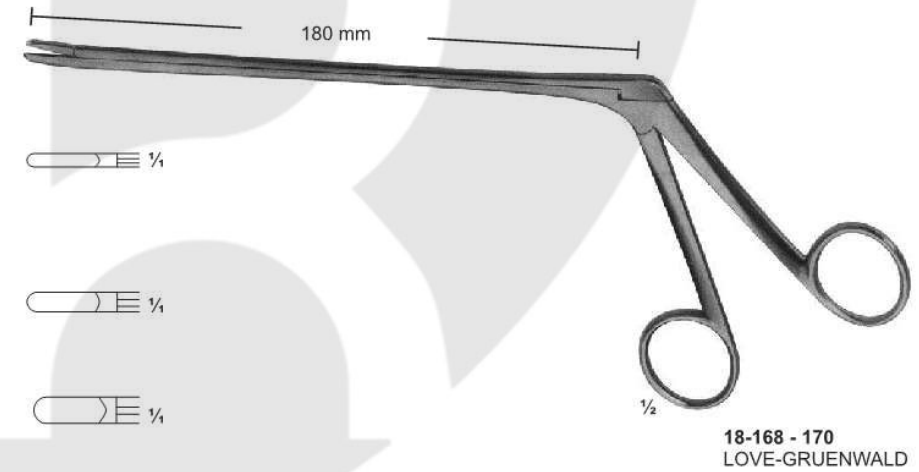

18-171
3 X 10 mm
LOVE-GRUENWALD

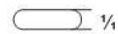

18-172
4 X 10 mm
SPURLING

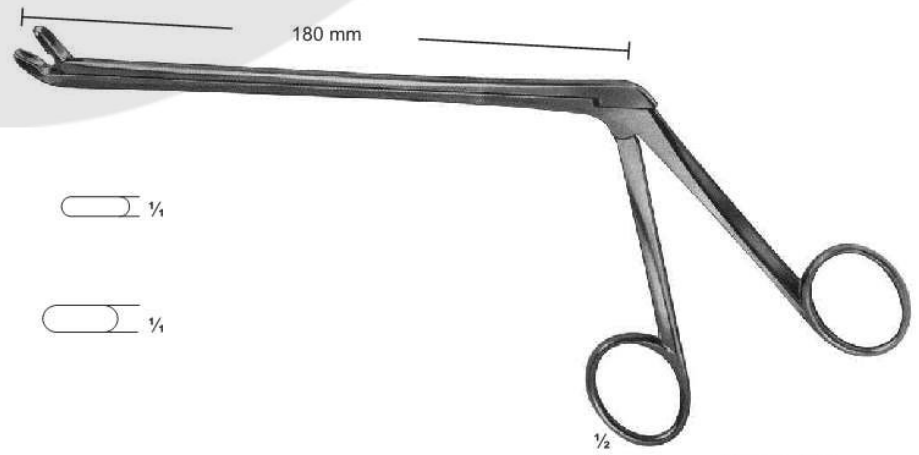

18-171 - 172
LOVE-GRUENWALD

Rongeurs

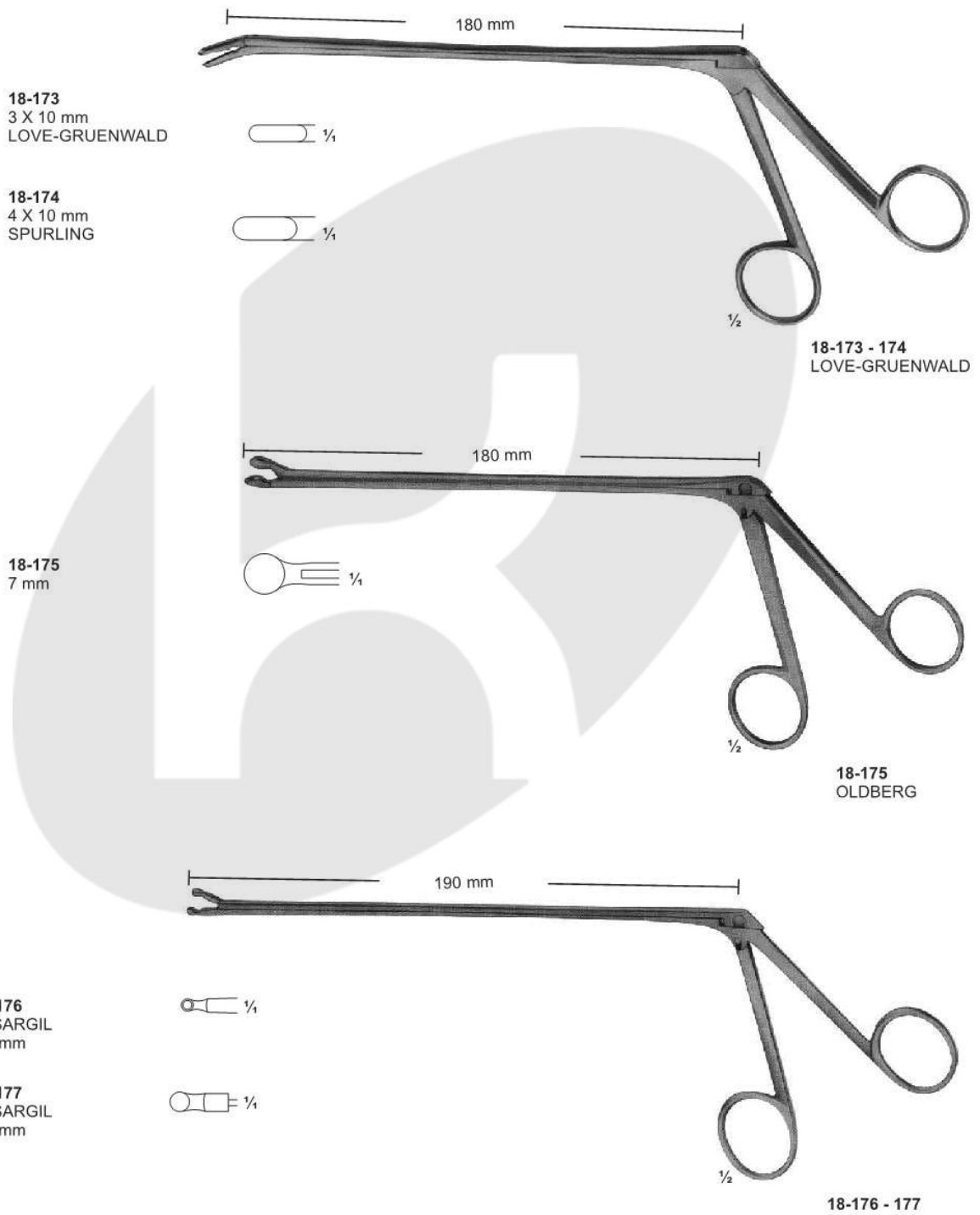

Rongeurs

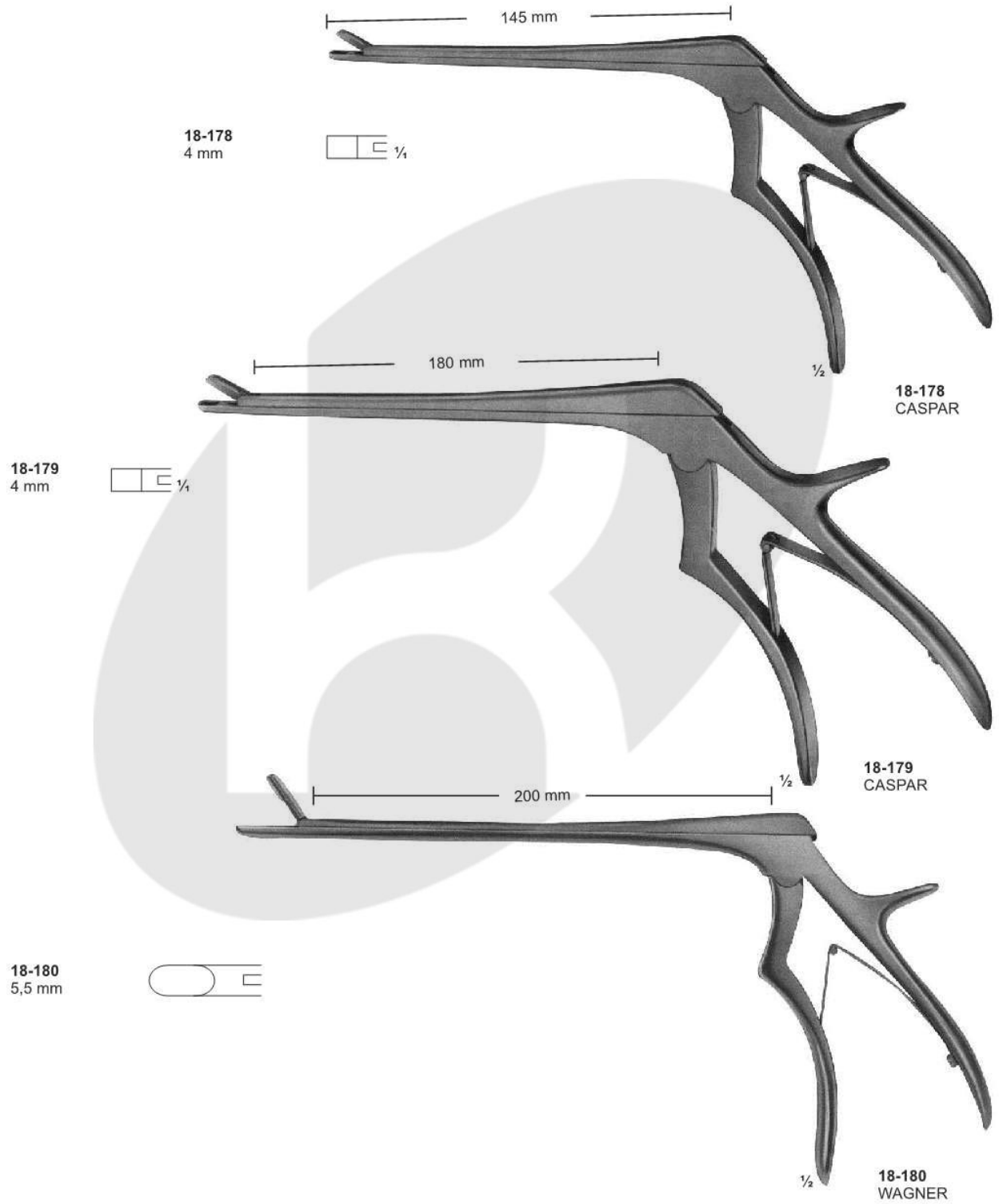

Amputation

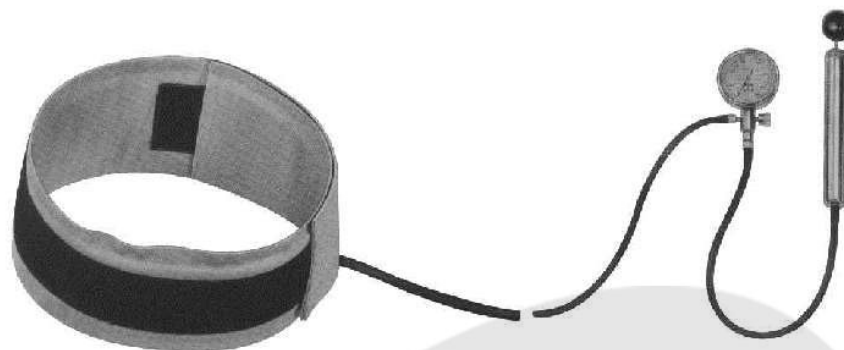

19-101
Comprimeter. Compression apparatus for producing exsanguination in the extremities. Manometer registers up to 600 mm Hg. Complete, consisting of:
19-101 2 Pump with manometer
19-102 3 Cuff for the leg
19-103 14 Cuff for the upper arm

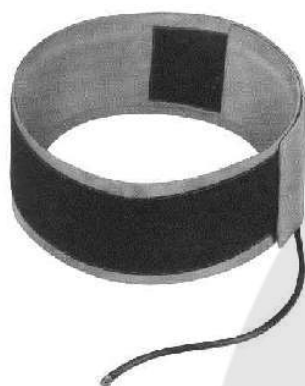

19-104 3 Cuff for the leg
19-105 4 Cuff for the lower arm
19-106 5 Cuff for children
19-107 14 Cuff for the upper arm

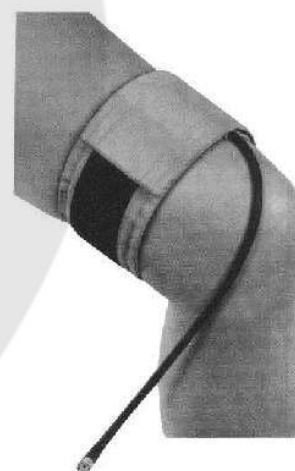

19-108
ESMARCH
Staubinde
Compression bandage
5 m lang/long
6 cm breit/wide



19-109
ESMARCH
Stauschlauch
Compression tube
1 m lang/long

Amputation and Resection Knives



19-110
Length of blades
Phalangeal knife
105 mm



19-111
Length of blades
Interosseous knife
110 mm



19-112
Length of blades
Periosteum knife
with raspator
65 mm



19-113 - 114
LANGENBECK
Length of blades
Resection knives
55 mm



19-113



19-114

Amputation Retractors

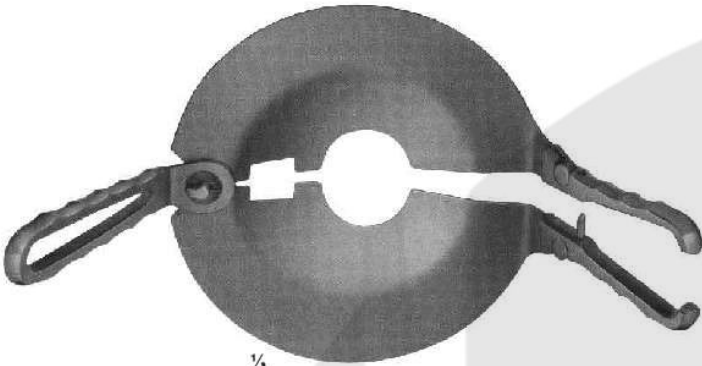

1/4

19-115
PERCY
removeable handles

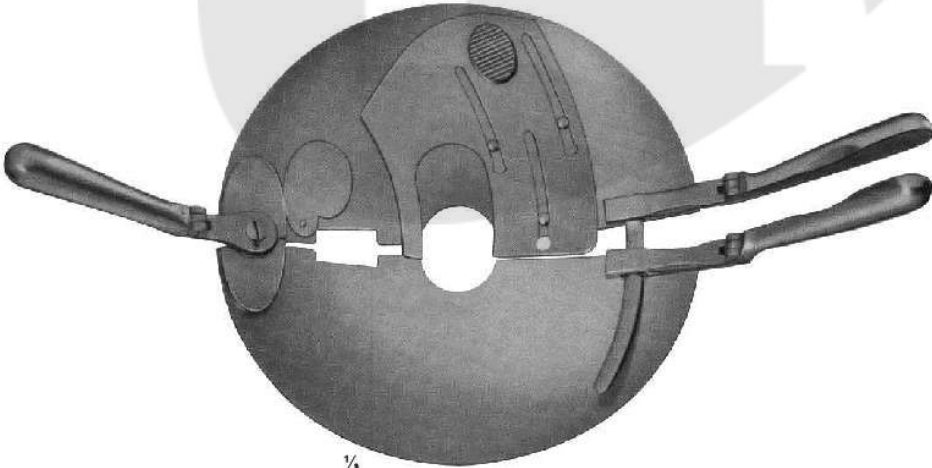

1/4

19-116
PERCY
reversible handles

Amputation Saws

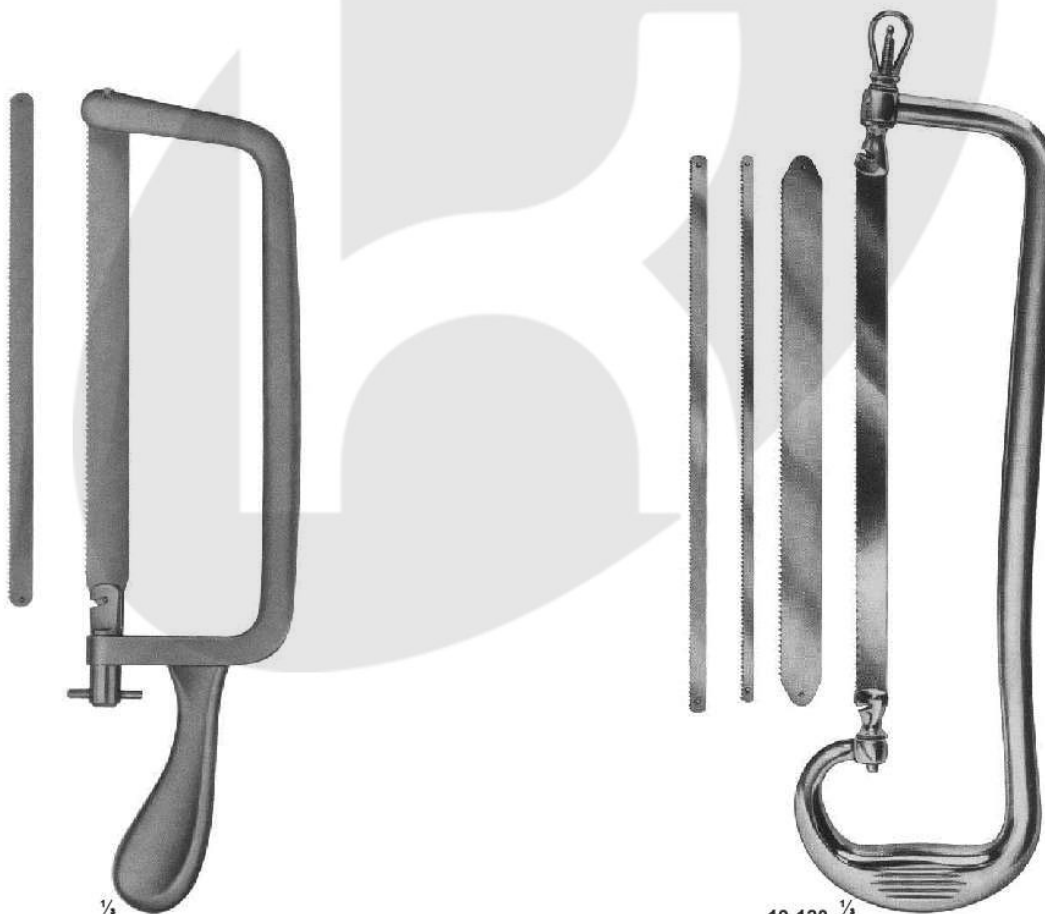

1/4
19-117
 CHARRIEER
 Length of blade
 215 mm
 complete with one saw
 blade each
 350 mm
 Spare saw blades, carbon steel
19-118 12 mm
19-119 20 mm

1/4
19-120
 RUST
 Length of blade
 235 mm
 complete with one saw
 blade each
 390 mm
19-121 Bow only
 Spare saw blades, carbon steel
19-122 6 mm
19-123 8 mm
19-124 12 mm
19-125 20 mm

Amputation Saws

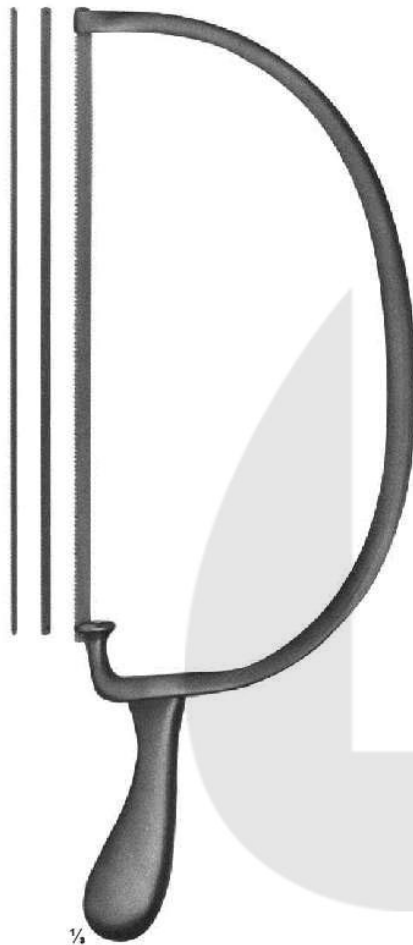

19-126
BIER
 Length of blade
 270 mm
 complete with one saw
 blade each
 420 mm
 Spare saw blades, carbon steel
19-127 4 mm
19-128 6 mm
19-129 8 mm



19-130
CHARRIERE
 Length of blade
 180 mm
 Spare saw blades,
 carbon steel
 270 mm

19-131
CHARRIERE
 Length of blade
 240 mm
 Spare saw blades,
 carbon steel
 340 mm



19-132
SATTERLEE
 Length of blade
 200 mm
 Spare saw blades,
 carbon steel
 290 mm



19-133
LANGENBACK
 Length of blade
 115 mm
 Metacarpal saw
 235 mm

Wire Saws and Conductor

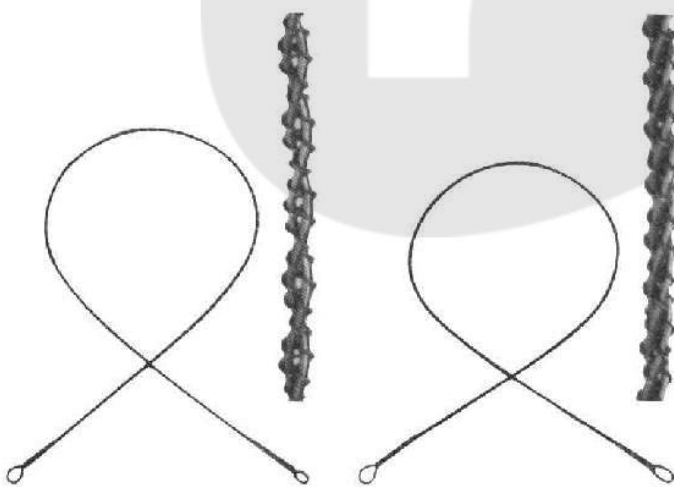

OLIVECRONA
19-134 300 mm
19-135 400 mm
19-136 500 mm
19-137 700 mm

GIGLI
19-138 300 mm
19-139 400 mm
19-140 500 mm
fine, 6 wires twisted
19-141
coarses, 4 wires twisted



19-142
GIGLI
Handle



19-143
LEBSCH
Conductor for
wire saws, malleable
250 mm

Elevators and Bone Levers



Bone Levers

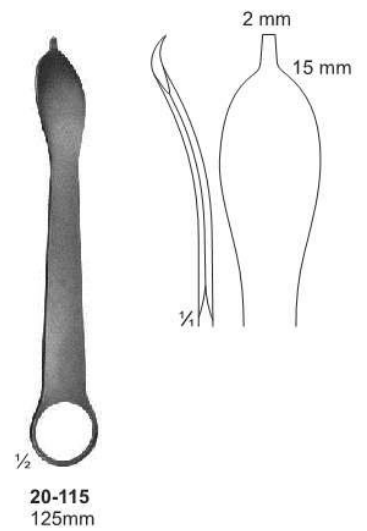
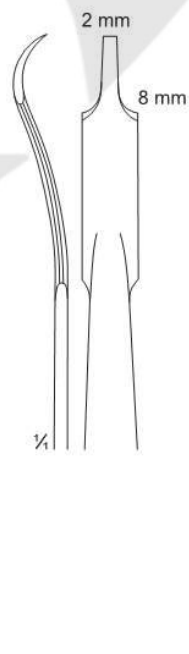
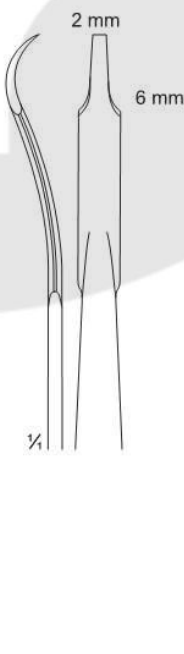
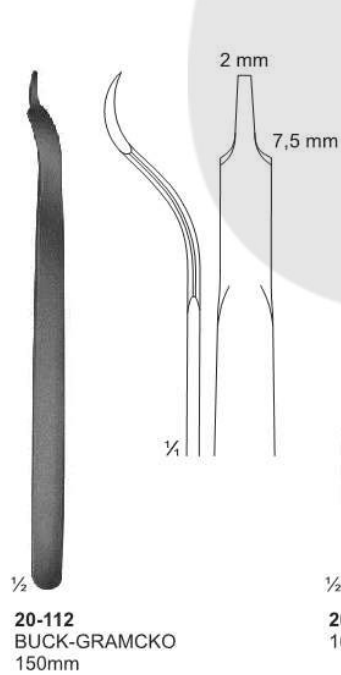
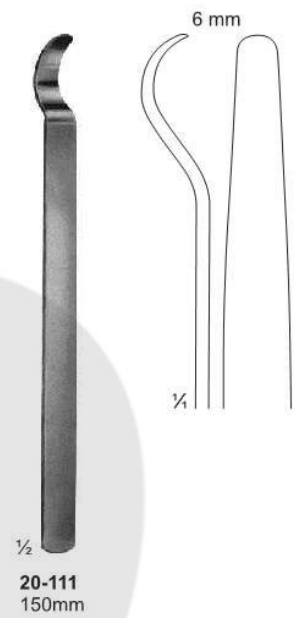
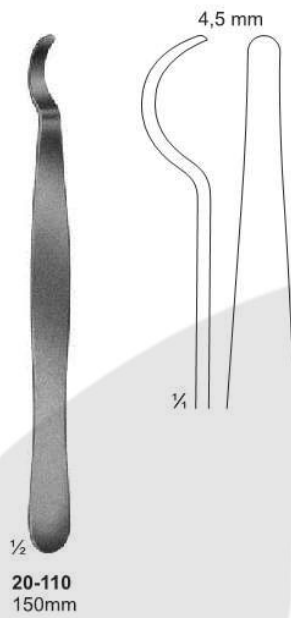
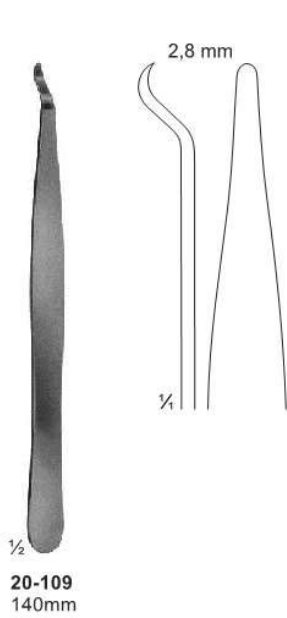

Bone Levers



20-116
LANE TRETHOWAN
215mm

20-117
LANE
255mm

20-118
LANGE-HOHMANN
250mm

20-119 - 120
LANGE-HOHMANN
20-119 265mm
20-120 280mm

Bone Levers

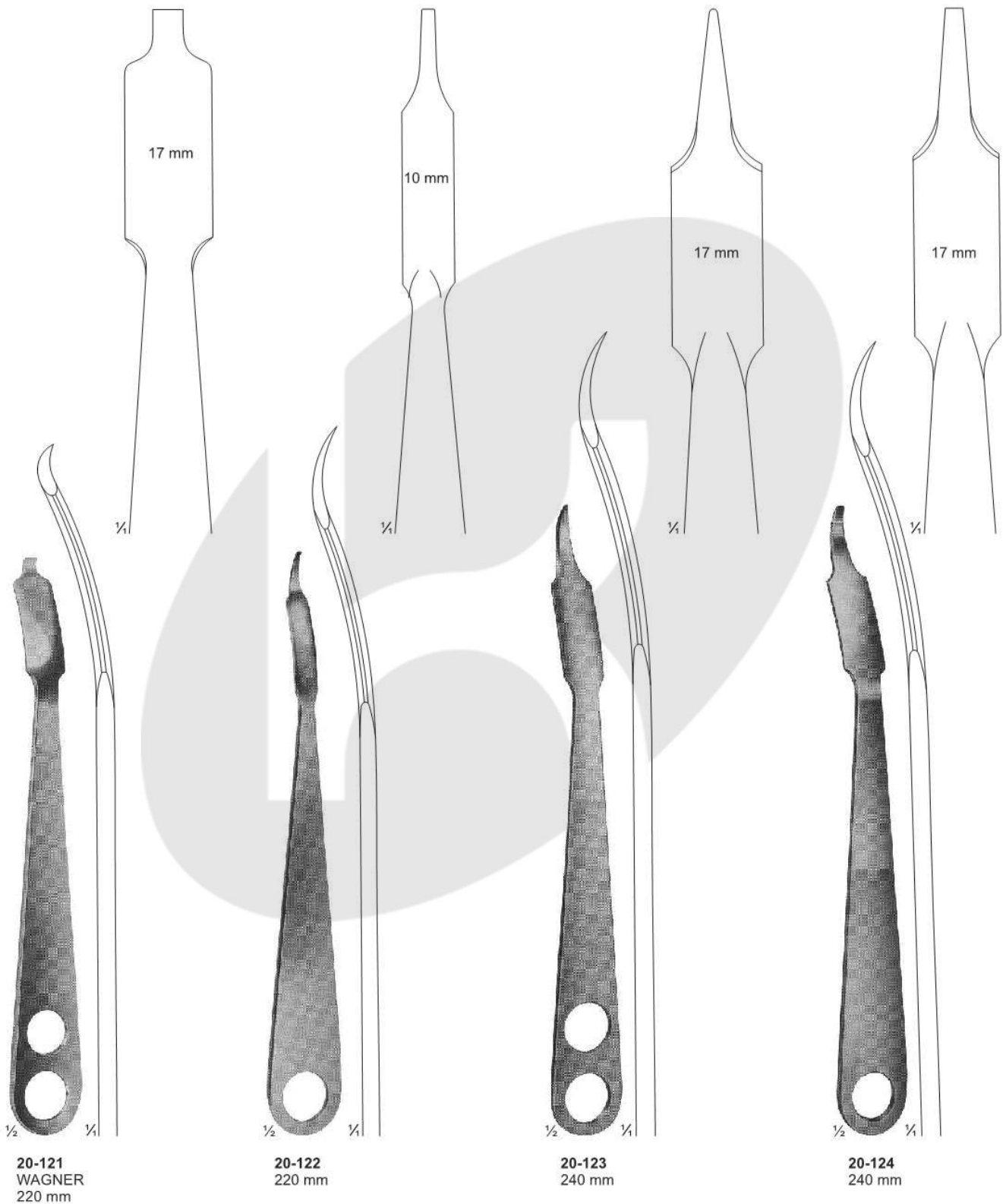

Bone Levers

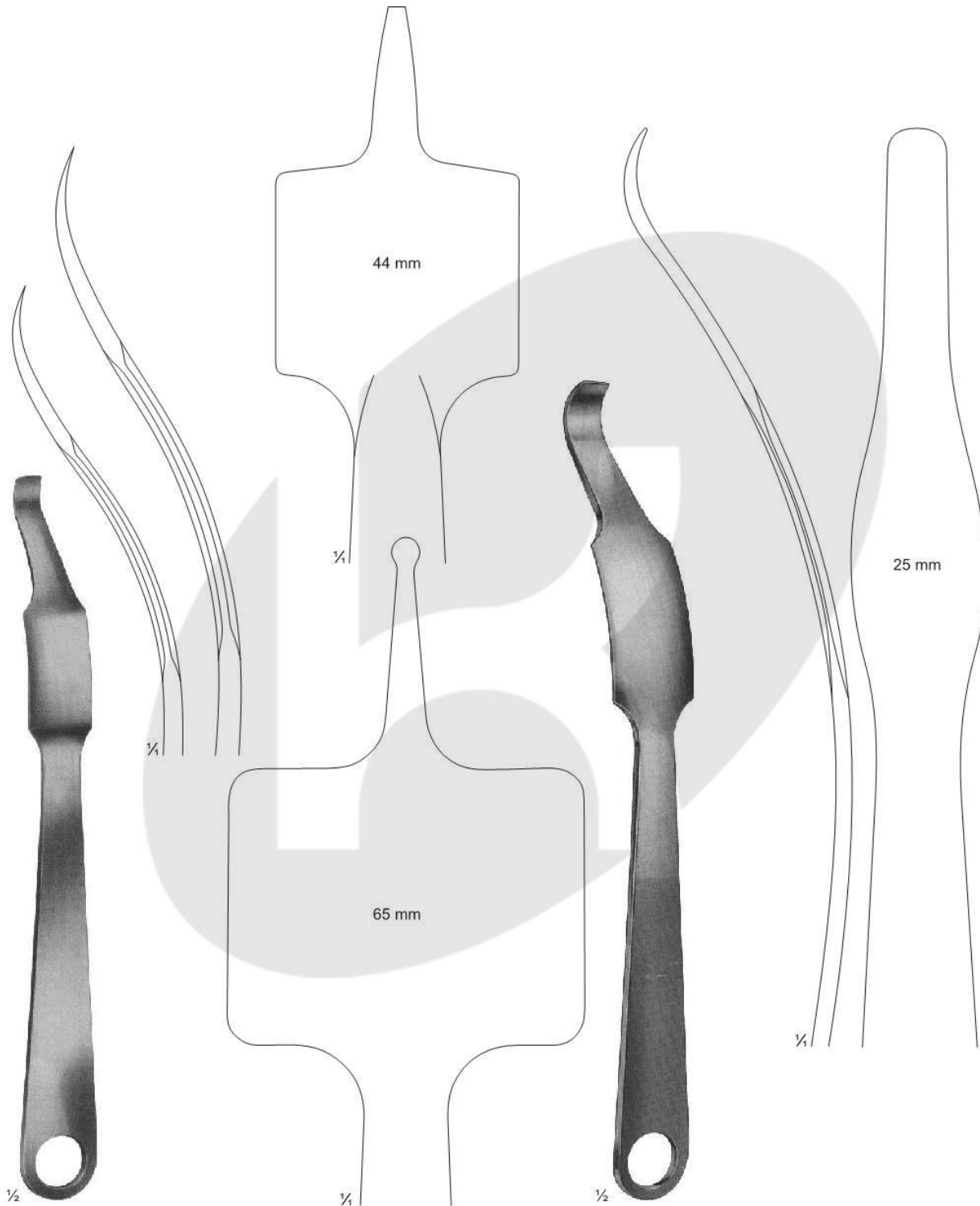

20-125 - 126
VERBRUGGE-MULLER
 20-125 240 mm
 20-126 255 mm

20-127
 260 mm

Bone Levers

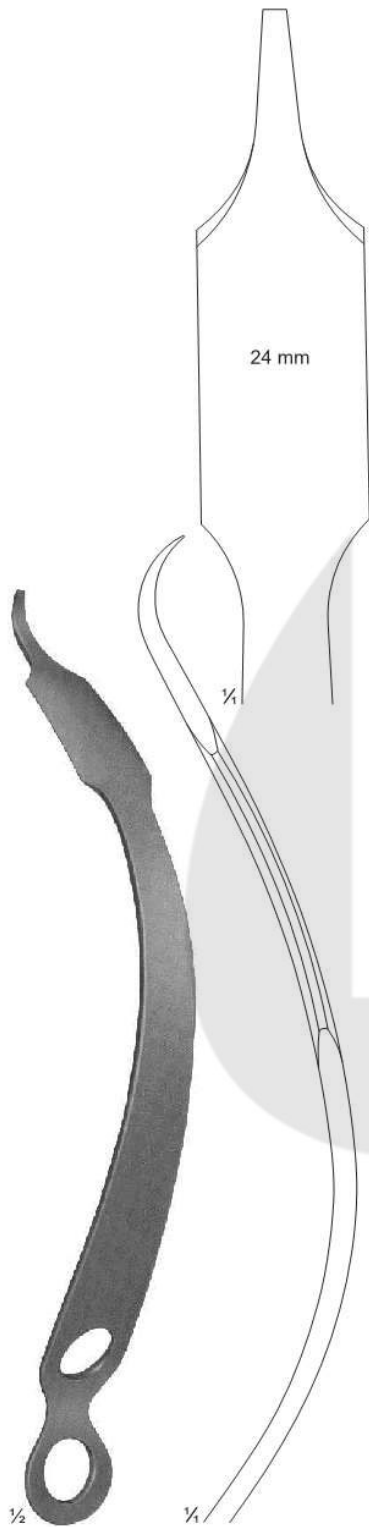

20-128
HOHMANN-ALDINGER
270 mm

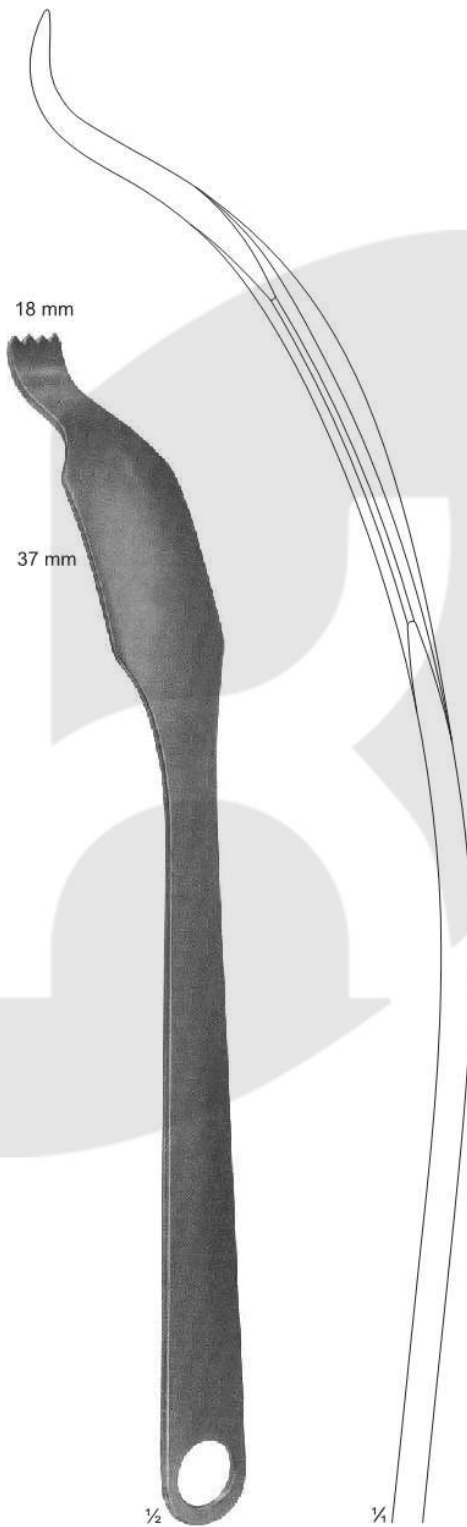

20-129
SCHUMACHER mod. WAGNER
345 mm

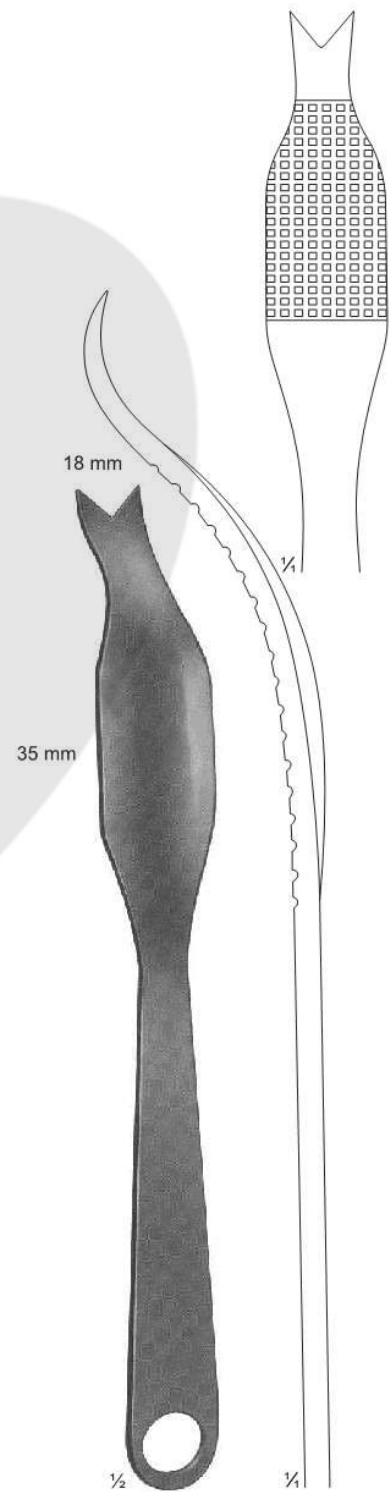

20-130
SCHUMACHER
290 mm

Special Bone Levers

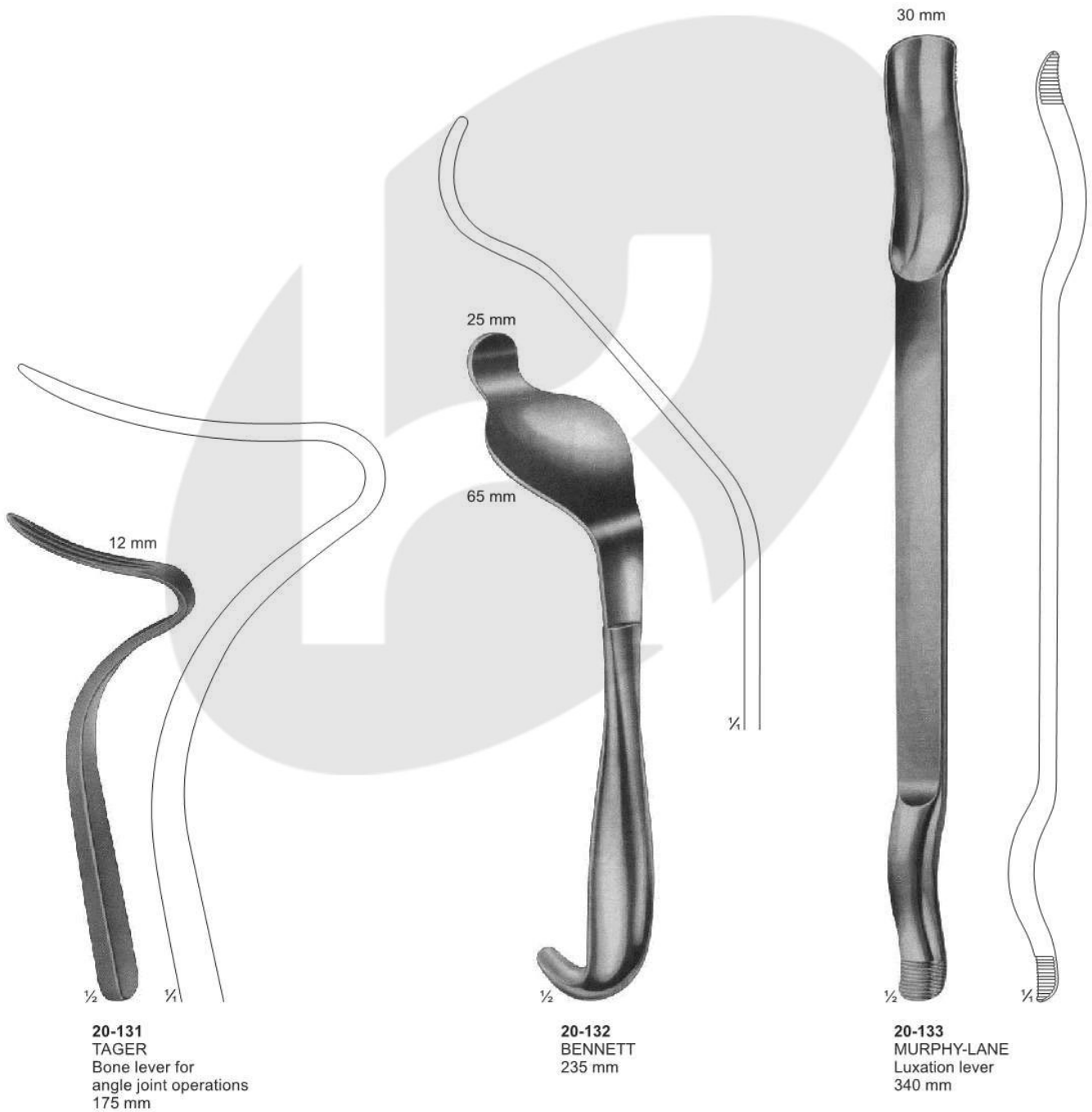

Raspatories

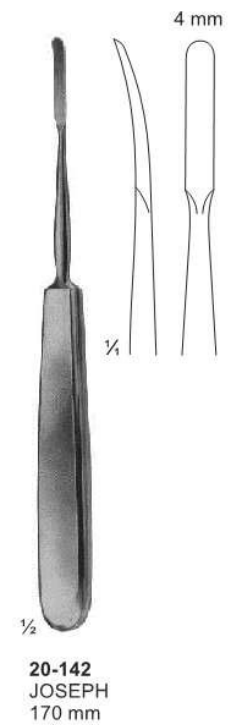
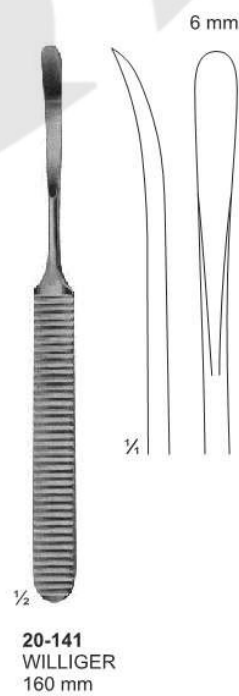
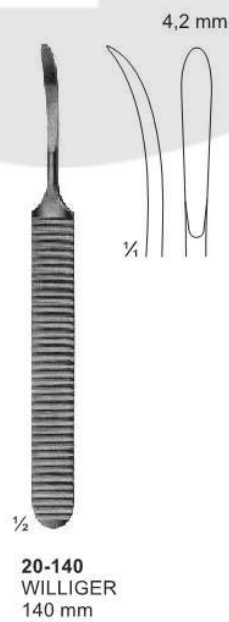
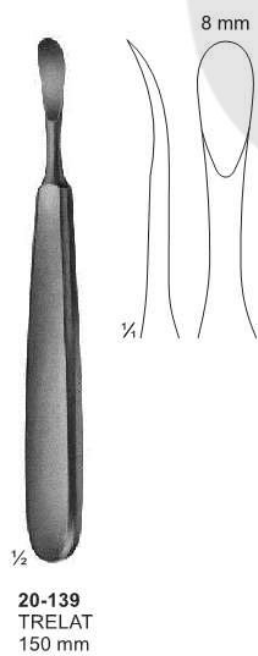
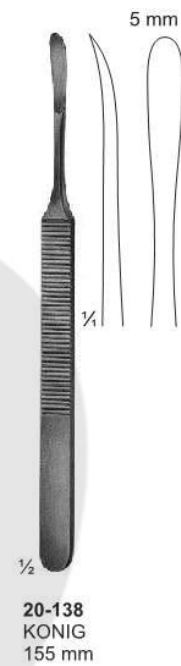
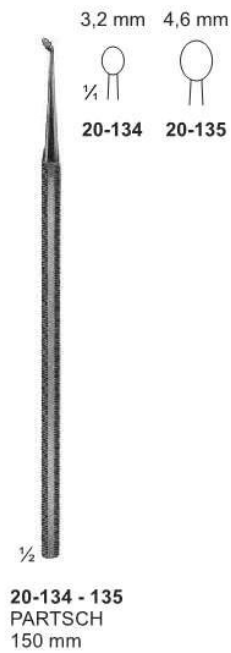

Raspatories



20-143
HALLE
stumpf/blunt
180 mm

20-144
FREER
stumpf/blunt
190 mm

20-145
FREER
stumpf/sharp
190 mm

20-146
SEWALL
stumpf/blunt
190 mm

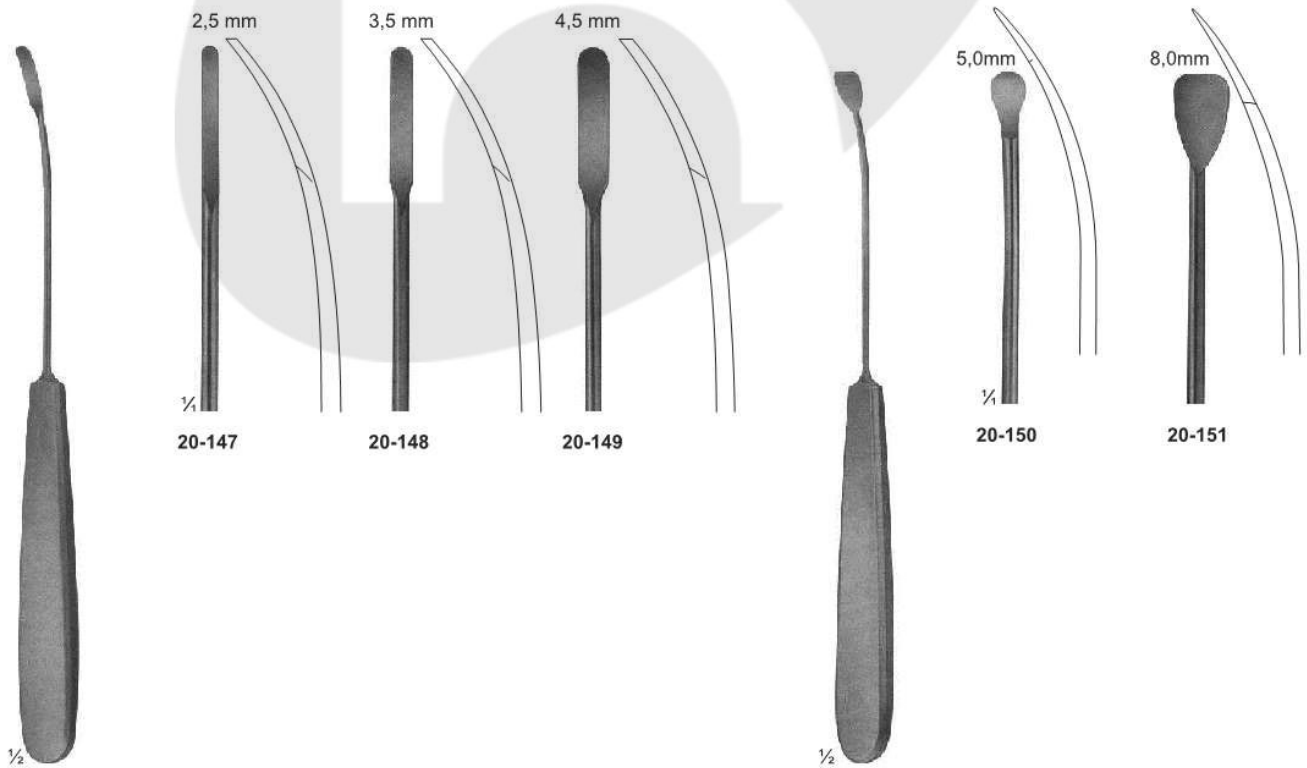

20-147 - 149
PAULSEN
205 mm

20-150 - 151
PAULSEN
205 mm

Raspatories

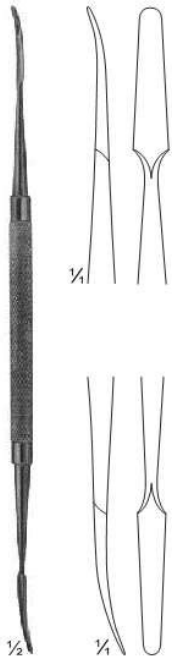

20-152
KILLIAN
sharp/blunt
185 mm

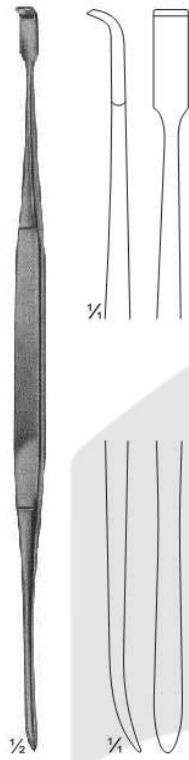

20-153
HOWARTH
sharp/blunt
215 mm

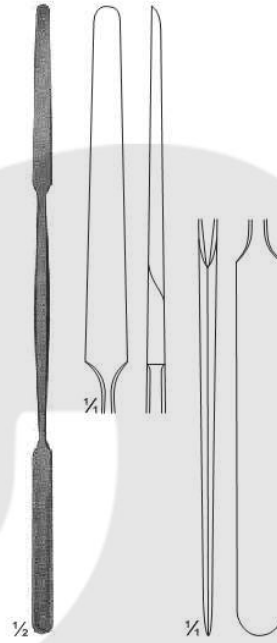

20-154
KILLIAN
sharp/blunt
185 mm

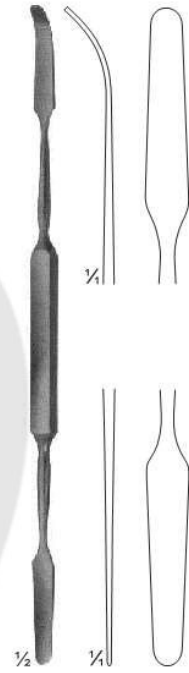

20-155
MAC DONALD
blunt/blunt
185 mm

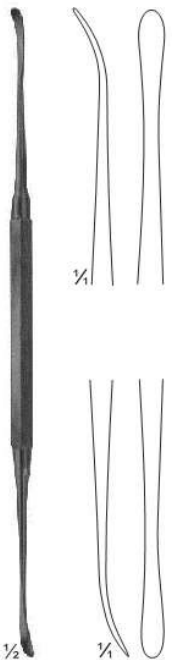

20-156
FREER
sharp/blunt
185 mm

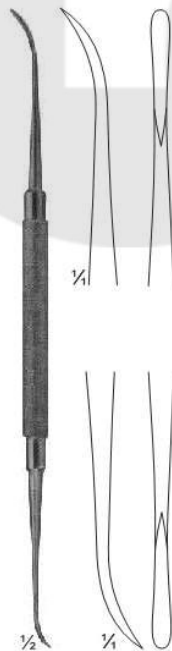

20-157
FREER-YASARGIL
sharp/sharp
185 mm

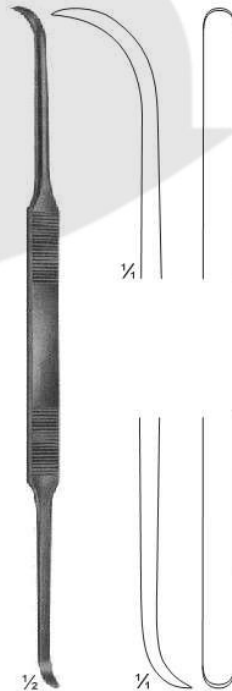

20-158
COTTLE
sharp/sharp
200 mm

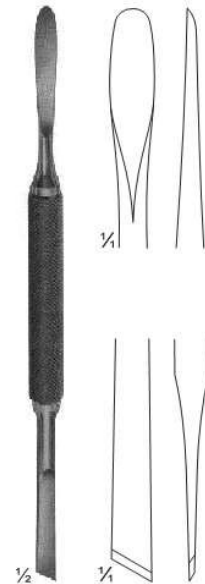

20-159
MEAD
sharp/sharp
165 mm

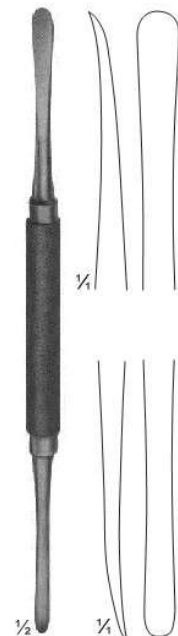

20-160
MOLT
sharp/sharp
180 mm

Raspatories

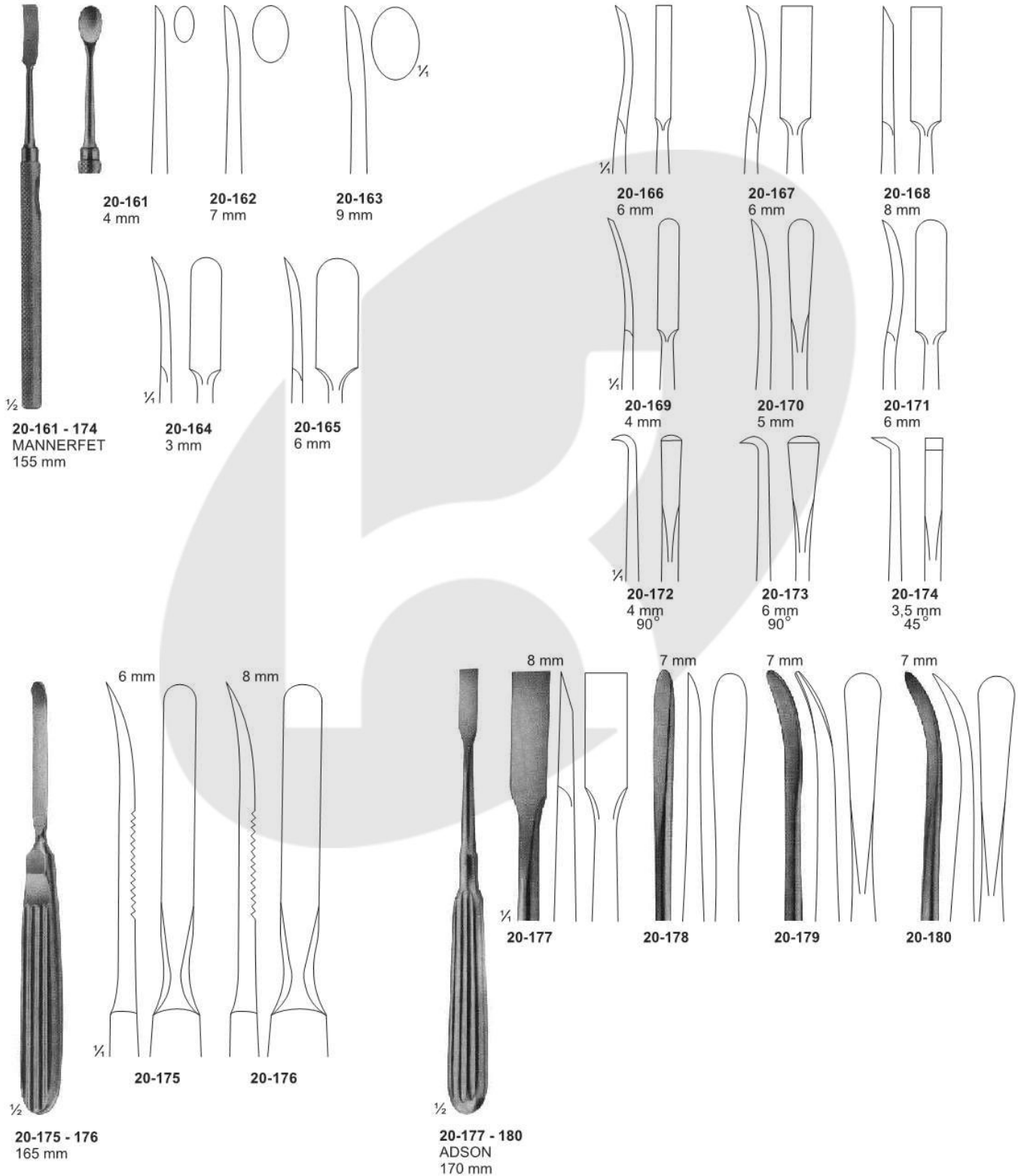

Raspatories

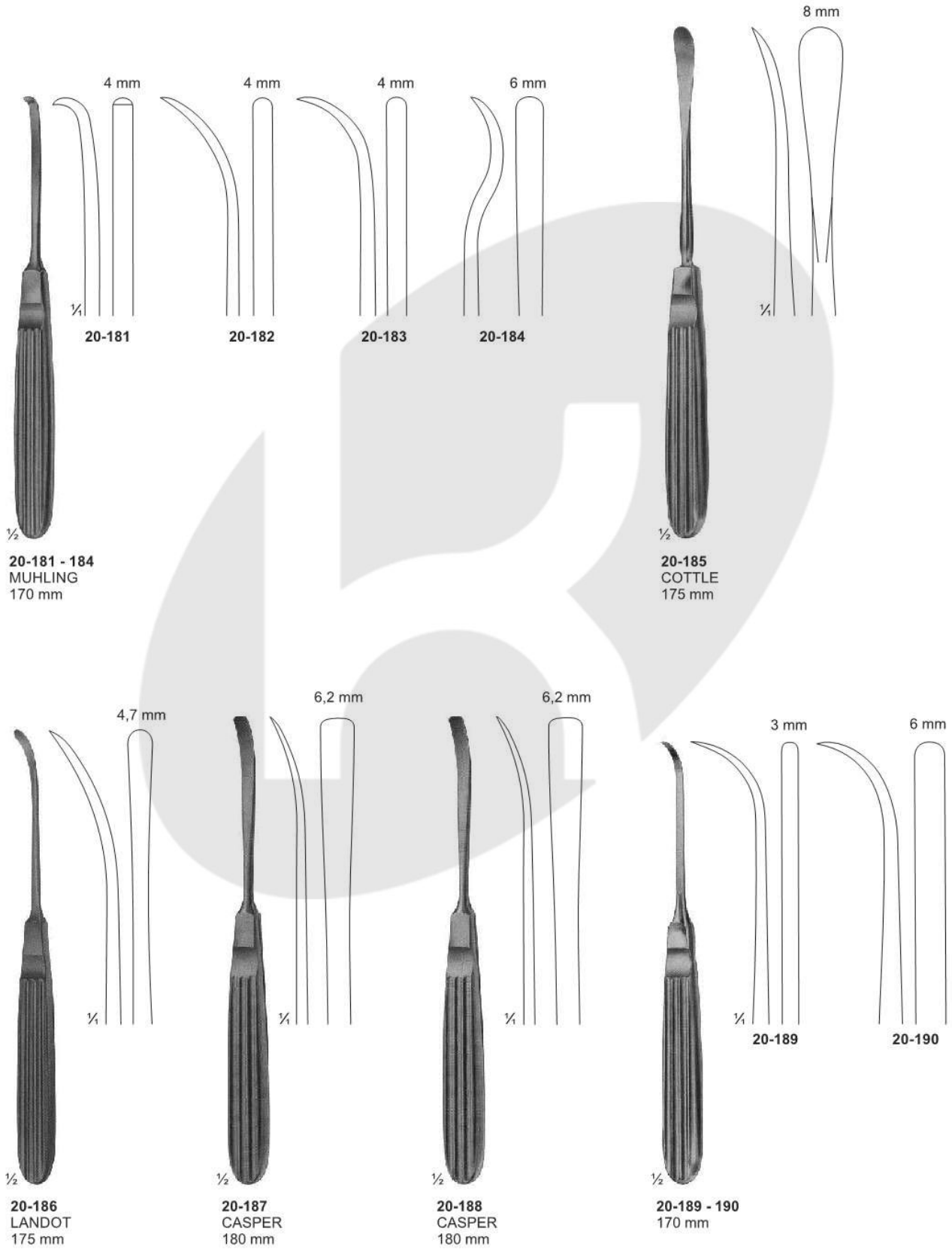

Raspatories

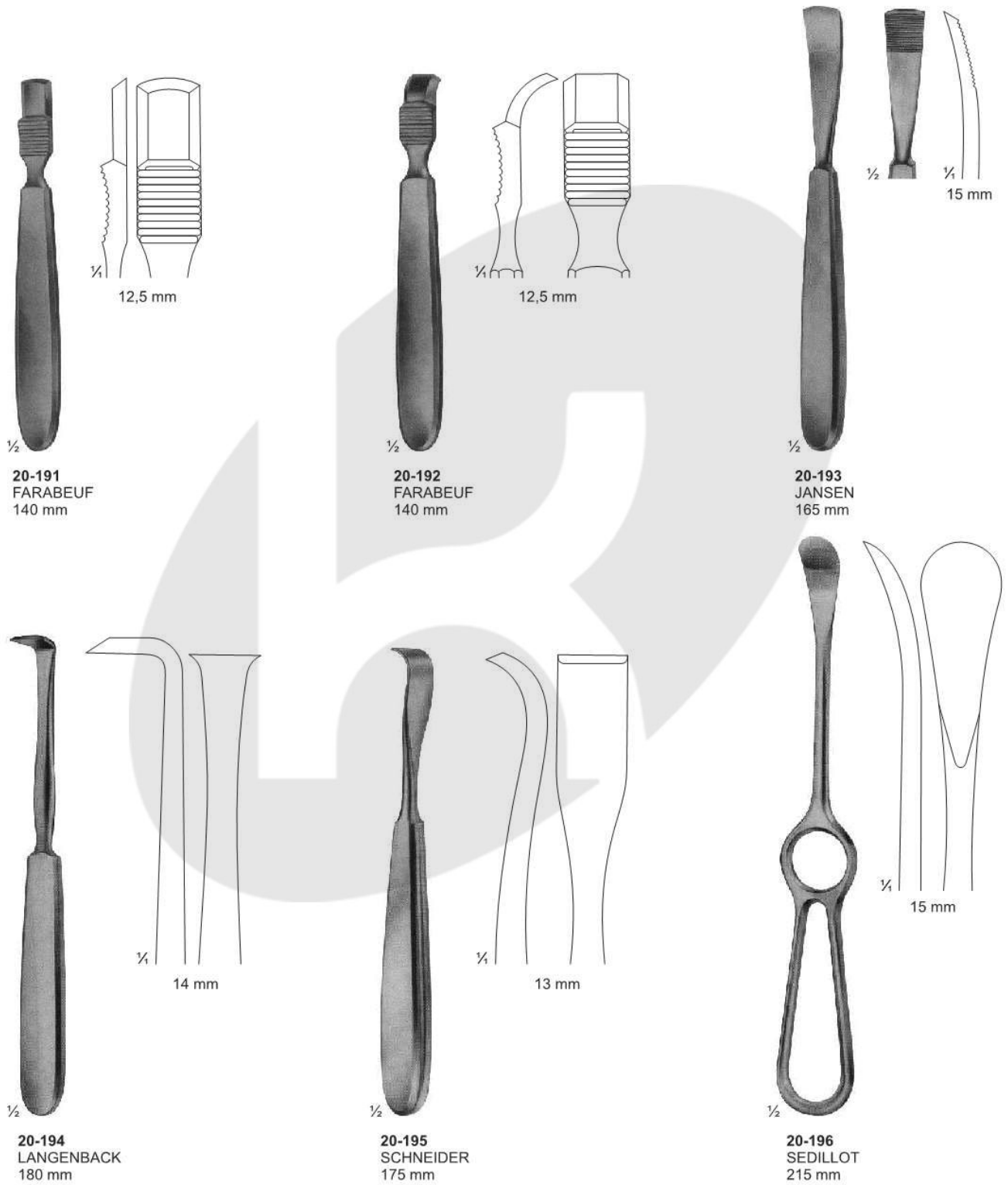

Raspatories

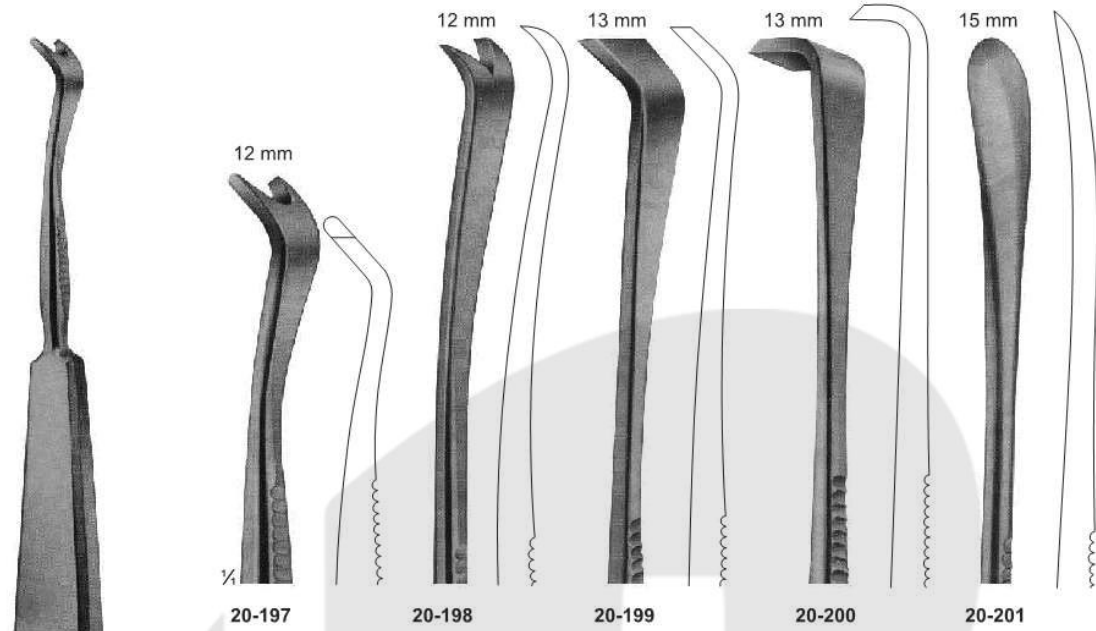

1/2
20-197 - 201
SEMB
230 mm

20-197

20-198

20-199

20-200

20-201

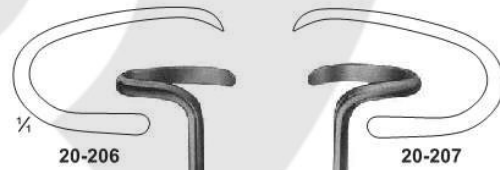

20-206

20-207



20-202 - 203
DOYEN
for children
20-204 - 205
for adults
175 mm

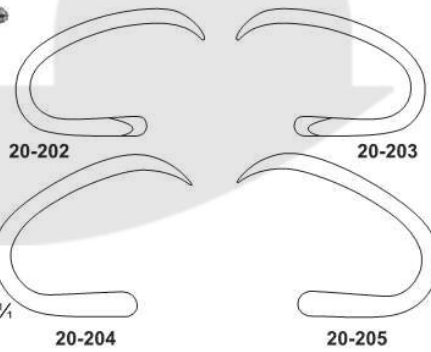

20-202

20-203

20-204

20-205



20-206 - 207
DOYEN
240 mm

Raspatories with HARTPRESS-handle

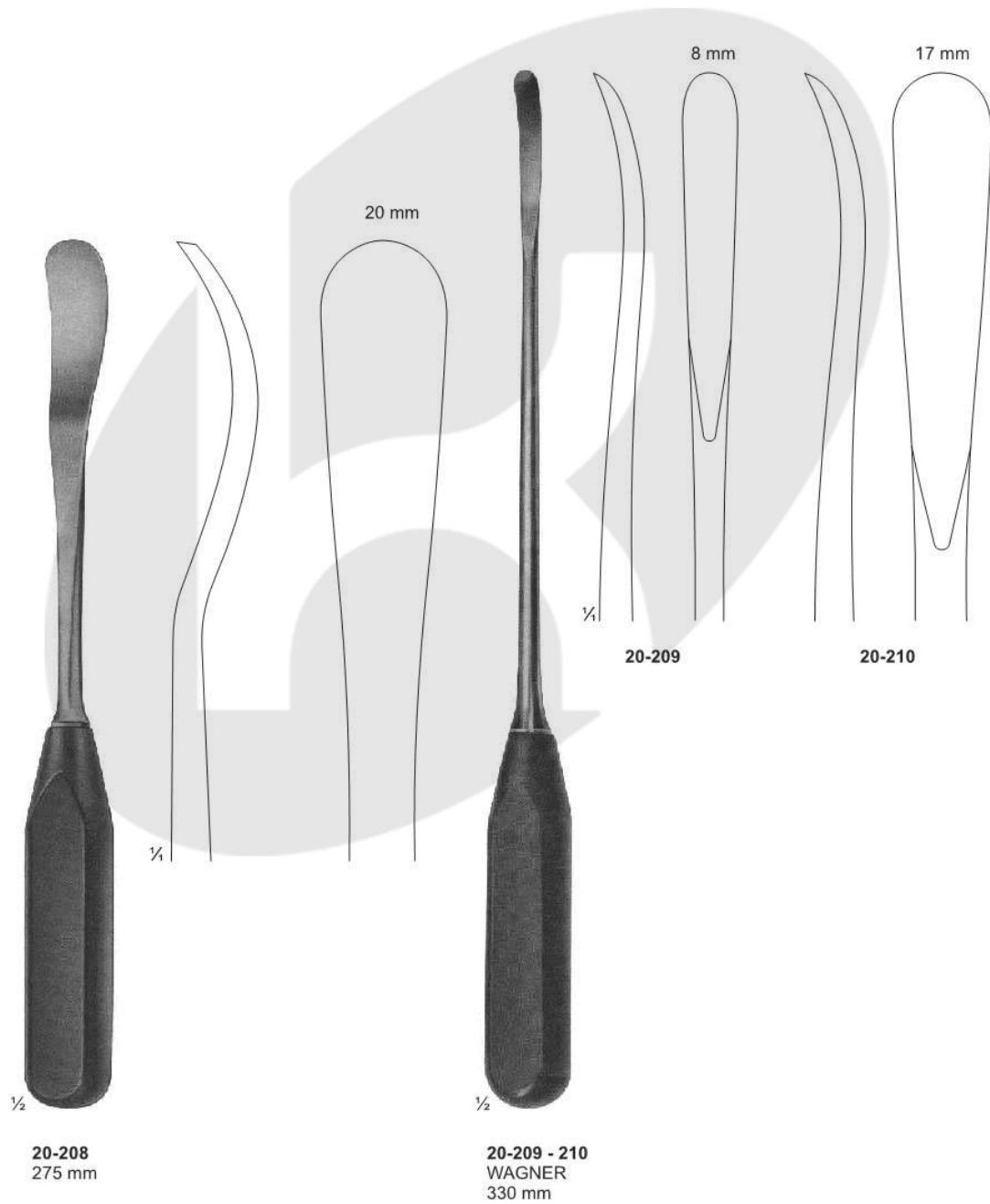

Bone File and Rasps

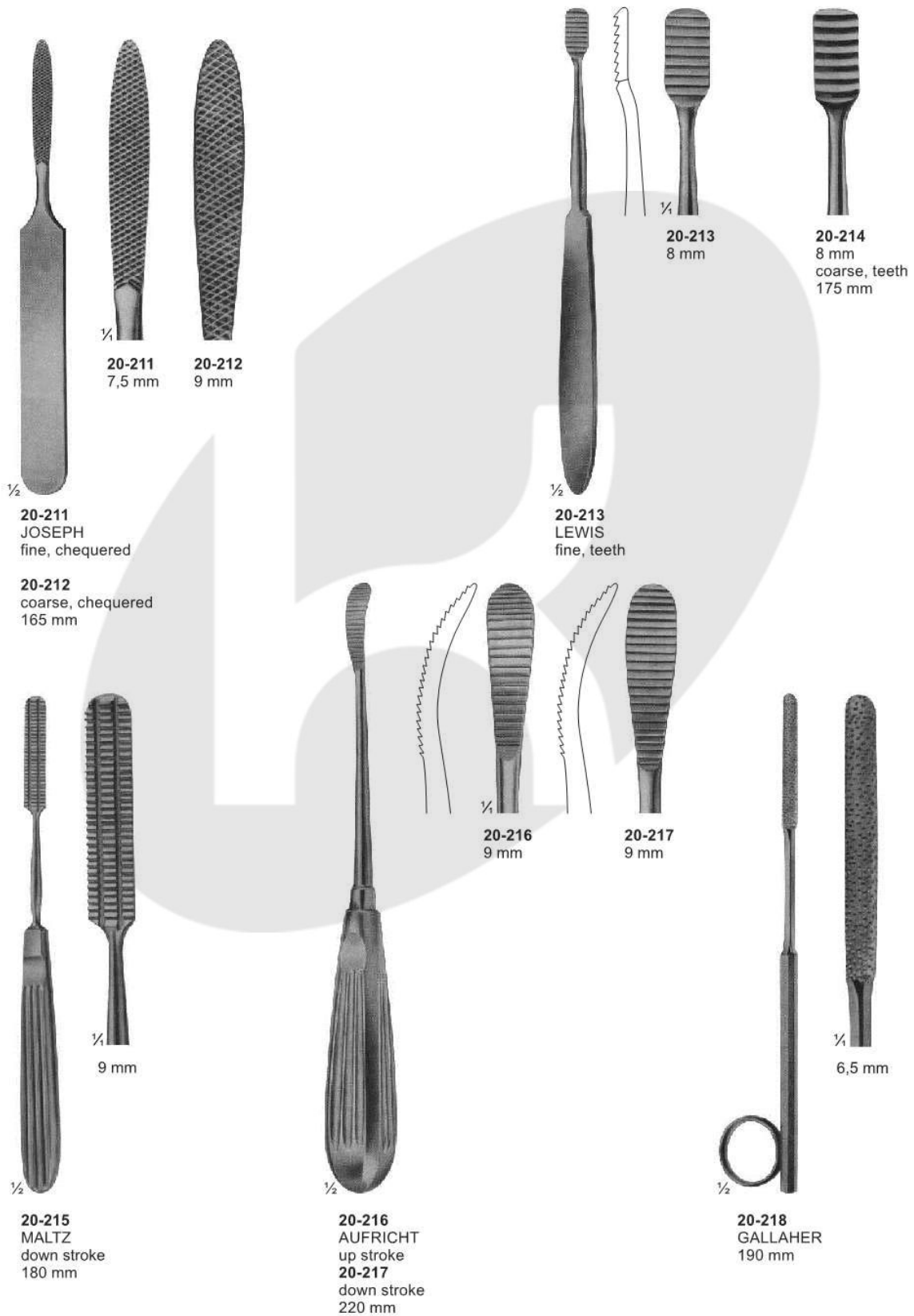

Bone File and Rasps

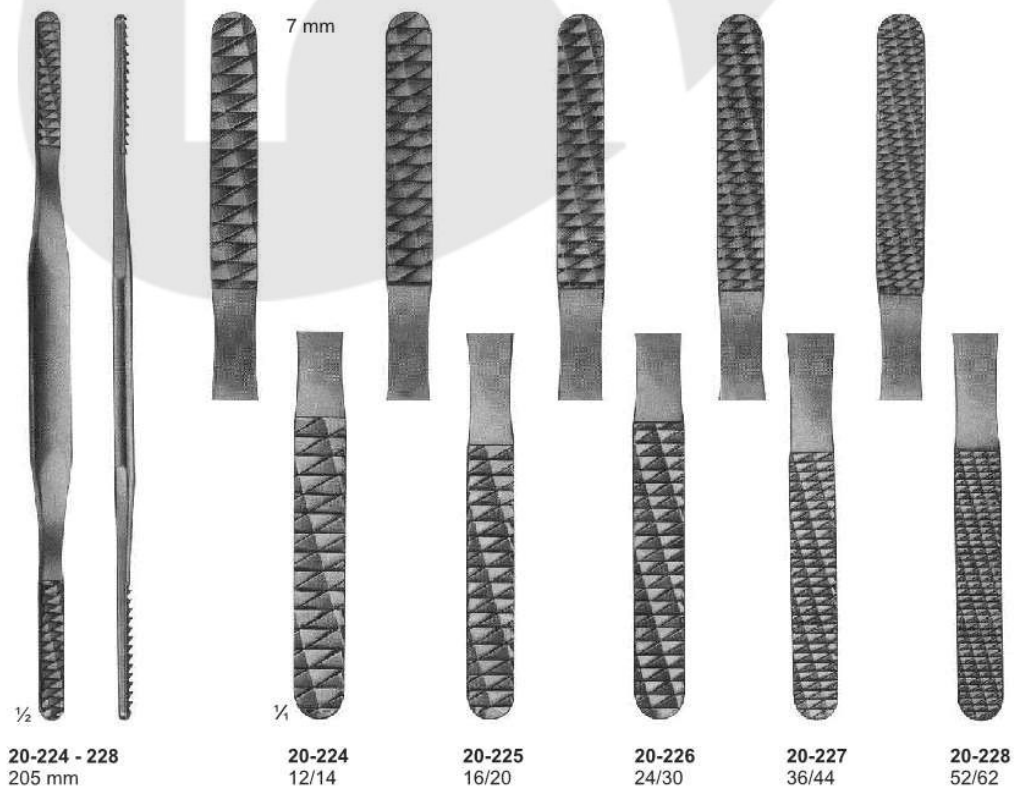
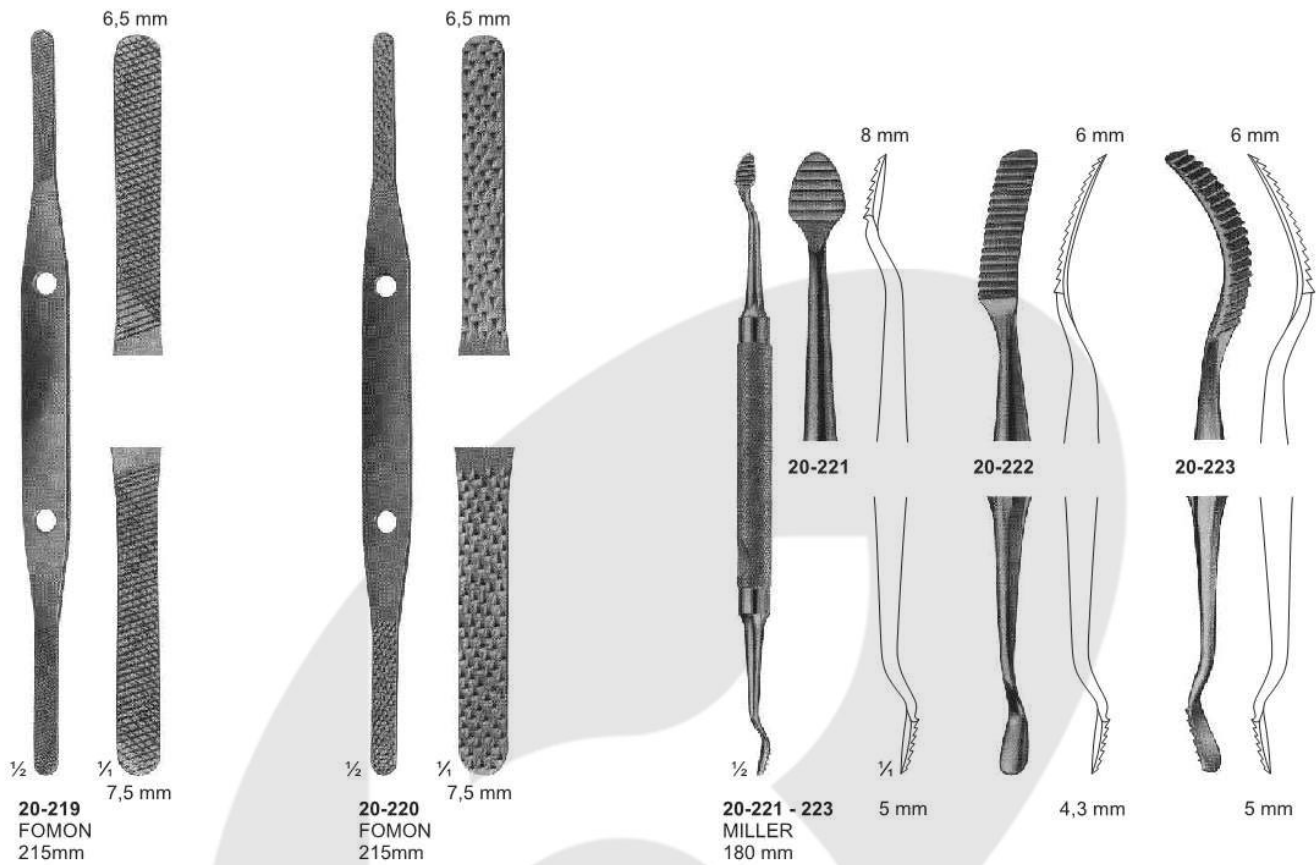

Bone File and Rasps

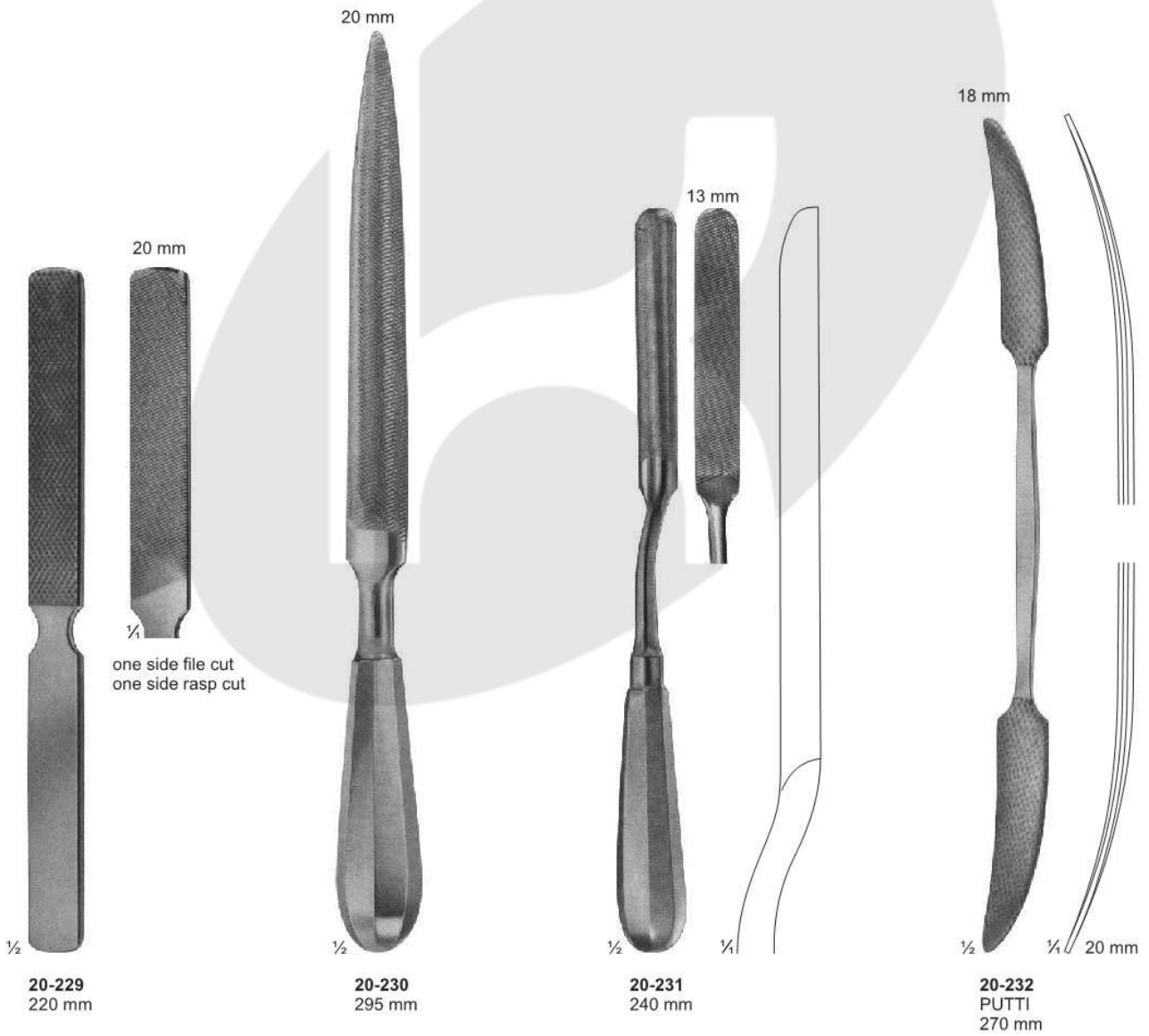

Bone Curettes



20-233
JACOBSON
140 mm

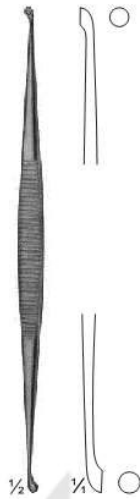

20-234
MARTINI
140 mm



20-235
MARTINI
140 mm



20-236
WILLIGER
145 mm



20-237
JANSEN
160 mm



20-238
BARTH
180 mm

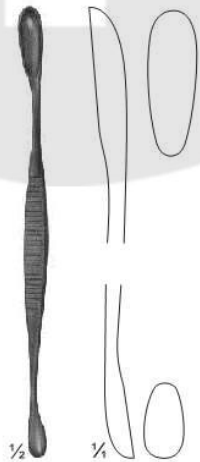

20-239
VOLKMANN
130 mm

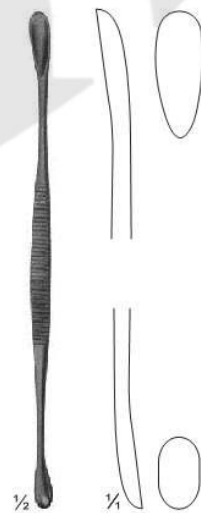

20-240
VOLKMANN
145 mm

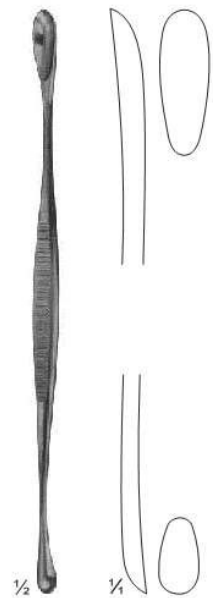

20-241
VOLKMANN
170 mm

Bone Currettes



20-242
JANSEN
160 mm



20-243
HEMINGWAY
170 mm

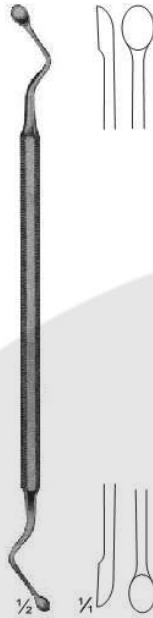

20-244
HEMINGWAY
175 mm



20-245
LUCAS
180 mm

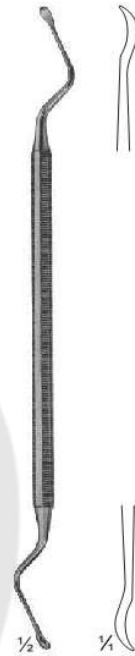

20-246
LUCAS
185 mm

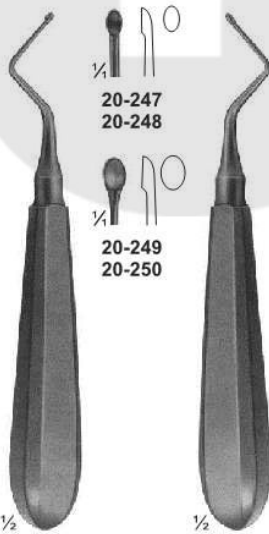

20-247 - 248
KERPEL
145 mm



20-249 - 250
KERPEL
145 mm

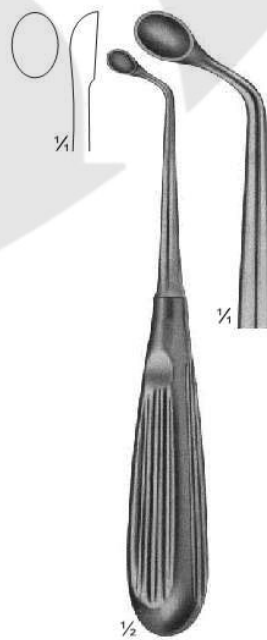

20-251
UFFENDORDE
170 mm

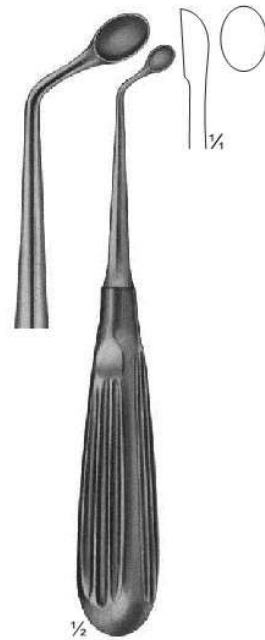

20-252
UFFENDORDE
170 mm

Bone Curettes



20-253 - 259
BRUNS
165 mm



20-253
3 mm
Fig: 000



20-254
4 mm
00



20-255
5 mm
0



20-256
6 mm
Fig: 1



20-257
8 mm
2



20-258
10 mm
3



20-259
12 mm
4



20-260 - 266
SCHEDE
170 mm



20-260
2,5 mm
Fig: 000



20-261
3,4 mm
00



20-262
4,2 mm
0



20-263
5,2 mm
Fig: 1



20-264
6,3 mm
2



20-265
7,4 mm
3



20-266
8 mm
4



20-267 - 276
VOLKMANN
170 mm



20-267
2,8 mm
Fig: 0000



20-268
3,6 mm
000



20-269
4,4 mm
00



20-270
5,2 mm
0



20-271
6,8 mm
1



20-272
8,5 mm
Fig: 2



20-273
10 mm
3



20-274
11,5 mm
4



20-275
13 mm
5



20-276
14,5 mm
6



20-277 - 278
WILLIGER
170 mm



20-277
3,4 mm
Fig: 00



20-278
5,2 mm
1

Bone Curettes

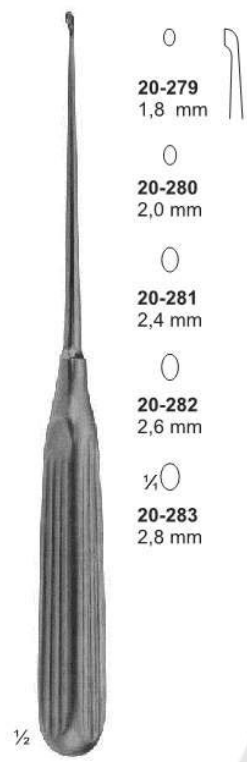

20-279
1,8 mm

20-280
2,0 mm

20-281
2,4 mm

20-282
2,6 mm

20-283
2,8 mm

1/2

20-279 - 283
LEMPERT
215 mm

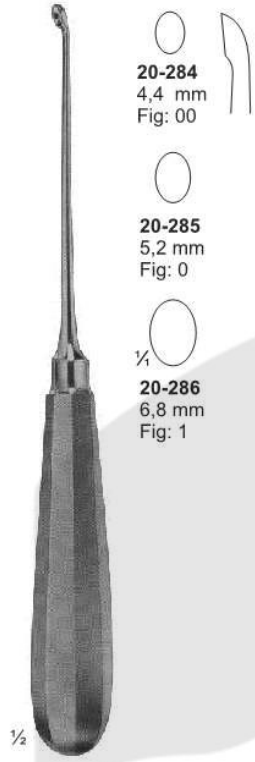

20-284
4,4 mm
Fig: 00

20-285
5,2 mm
Fig: 0

20-286
6,8 mm
Fig: 1

1/2

20-284 - 286
HALLE
215 mm



20-287
4,4 mm
Fig: 0000

20-288
5,2 mm
Fig: 000

20-289
5,2 mm
Fig: 00

20-290
6,8 mm
Fig: 0

1/2

20-287 - 290
DAUBENSPECK
200 mm



20-291
3,6 mm
Fig: 000

20-292
4,4 mm
Fig: 00

20-293
5,2 mm
Fig: 0

20-294
6,8 mm
Fig: 1

1/2

20-291 - 294
250 mm



20-295
3,6 mm
Fig: 000

20-296
4,4 mm
Fig: 00

20-297
5,2 mm
Fig: 0

20-298
6,8 mm
Fig: 1

1/2

20-295 - 298
250 mm



20-299
3 mm

20-300
4 mm

20-301
5 mm

1/2

20-299 - 301
BUSHE
250 mm

Bone Curettes

 <p>6 mm</p> <p>20-302 TESSIER 220 mm</p> <p>1/2</p>	 <p>20-303 3,6 mm Fig: 000</p>  <p>20-304 4,4 mm Fig: 00</p>  <p>20-305 5,2 mm Fig: 0</p>	 <p>20-306 6,8 mm Fig: 1</p> <p>20-307 8,5 mm Fig: 2</p> <p>20-308 10 mm Fig: 3</p> <p>20-309 11,5 mm Fig: 4</p> <p>20-310 13 mm Fig: 5</p> <p>20-311 14,5 mm Fig: 6</p> <p>20-306 - 311 SIMON 240 mm</p> <p>1/2</p>
 <p>20-312 3,6 mm Fig: 000</p> <p>20-313 4,4 mm Fig: 00</p> <p>20-314 5,2 mm Fig: 0</p> <p>20-312 - 314 CASPAR 220 mm</p> <p>1/2</p>	 <p>20-315 3,6 mm Fig: 000</p>  <p>20-316 4,4 mm Fig: 00</p>  <p>20-317 5,2 mm Fig: 0</p> <p>20-315 - 317 CASPAR 220 mm</p> <p>1/2</p>	 <p>20-318 4 mm</p>  <p>20-319 5 mm</p>  <p>20-320 6 mm</p> <p>20-318 - 320 CASPAR toothed 220 mm</p> <p>1/2</p>

Bone Curettes

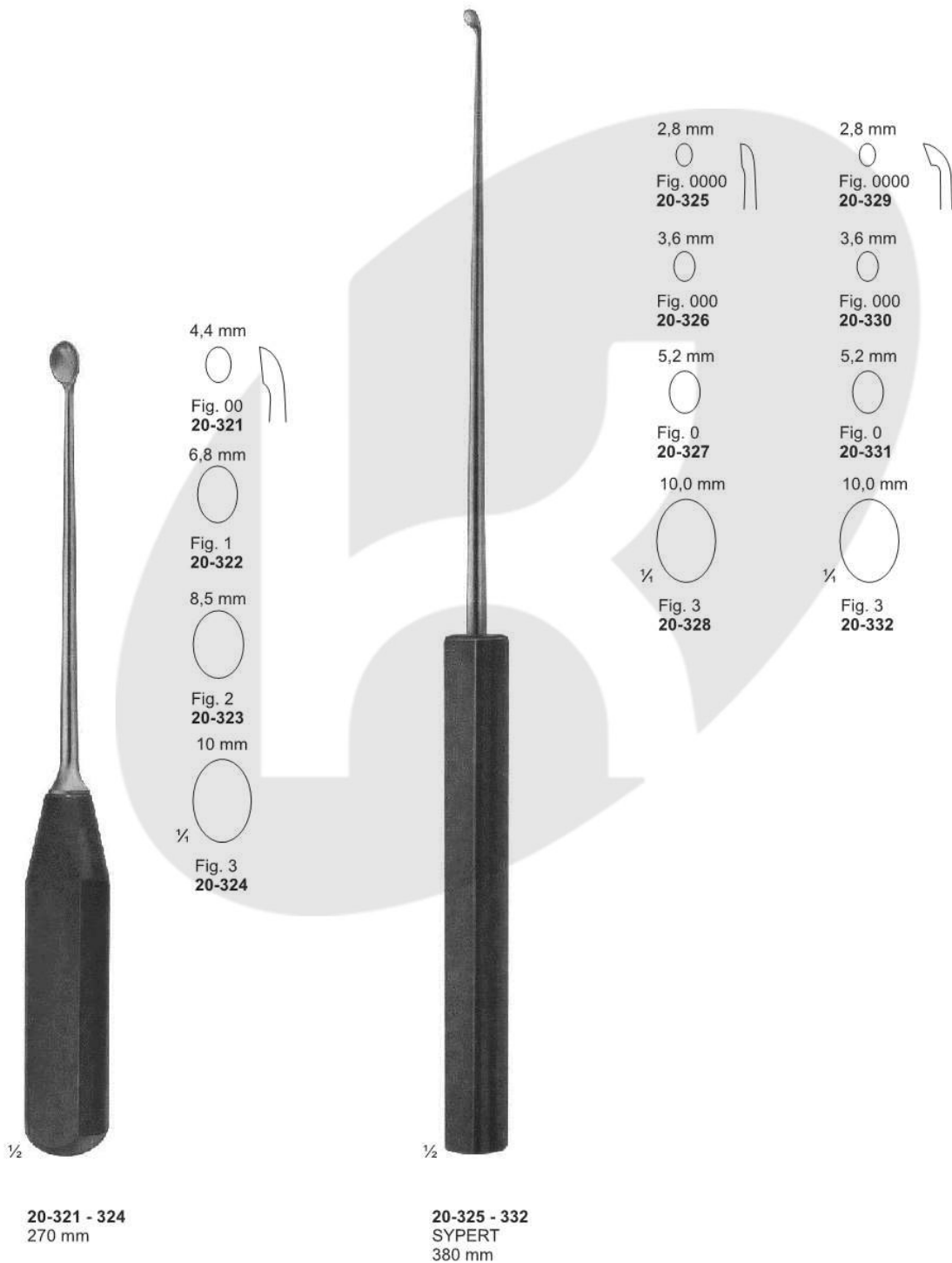

Mallets



Ø 20 mm

1/2

21-101
MEAD
185 g
with interchangeable
plastic disks
190 mm
21-102
pair of spare disks



1/2

21-103
140 g
with interchangeable
plastic disks
185 mm
21-104
pair of spare disks



Ø 25 mm

1/2

21-105
COTTLE
140 g
1 Seite convex
1 Side convex
185 mm



Ø 22 mm

1/2

21-106
165 g
lead filled head
190 mm

Mallets



Ø 27 mm

½

21-107
HAJEK
140 g
215 mm



Ø 30 mm

½

21-108
215 g
with interchangeable
plastic disks
245 mm
21-109
pair of spare disks

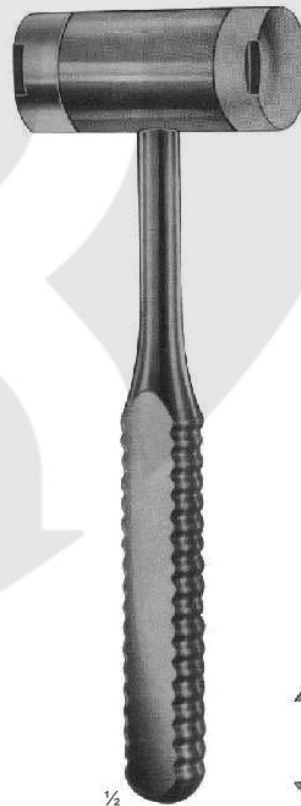

Ø 35 mm

½

21-110 - 113
WAGNER
complete with:
1 pair of metal disks and
1 pair of plastic disks and
1 wrench 566
235 mm

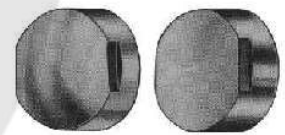

21-111
1 metal disks, flat
1 metal disks, convex

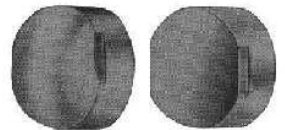

21-112
1 plastic disks, flat
1 plastic disks, convex

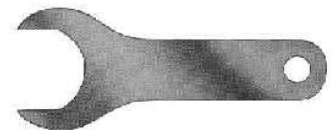

21-113
Wrench

Mallet without disks 130 g

Mallets



21-114
BERGMANN
245 mm



21-115
BERGMANN
235 mm



21-116
OMBREDANNE
240 mm

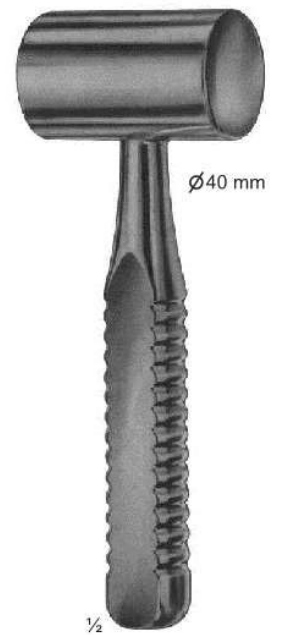

21-117
HEATH
copper filled head
700 g
185 mm

Tampers - Osteotomes, Chisels and Gouges

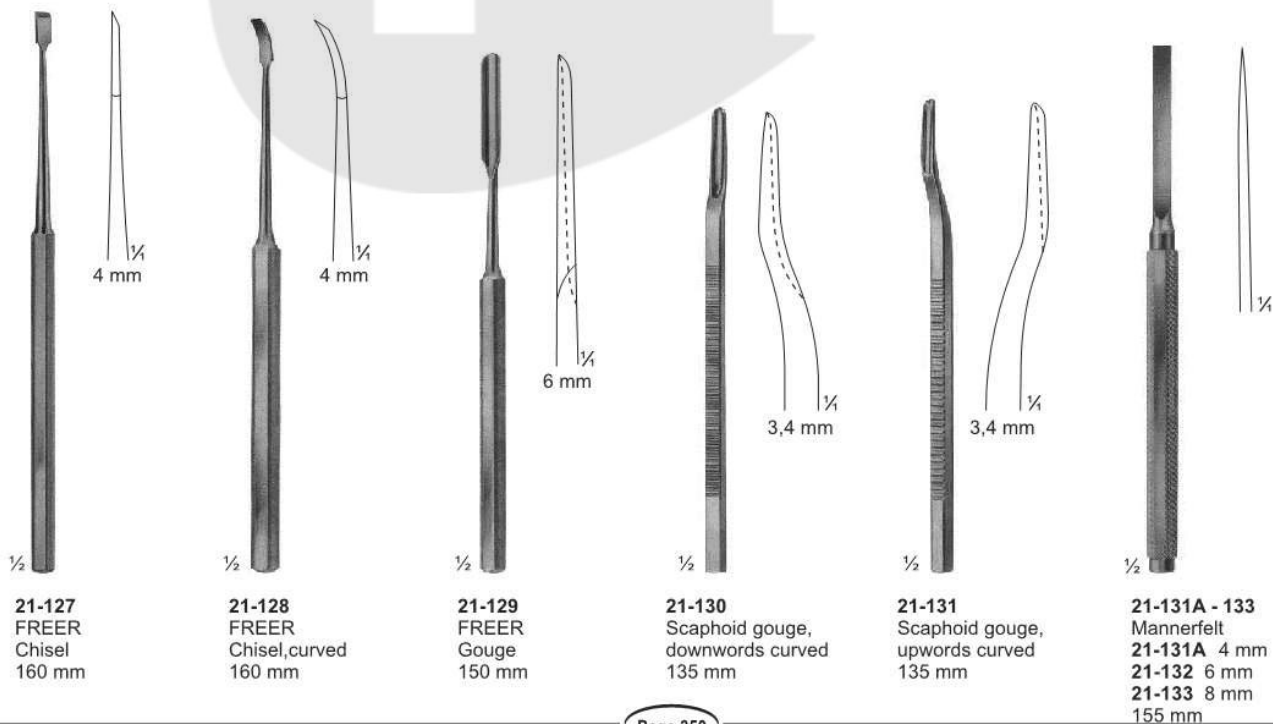
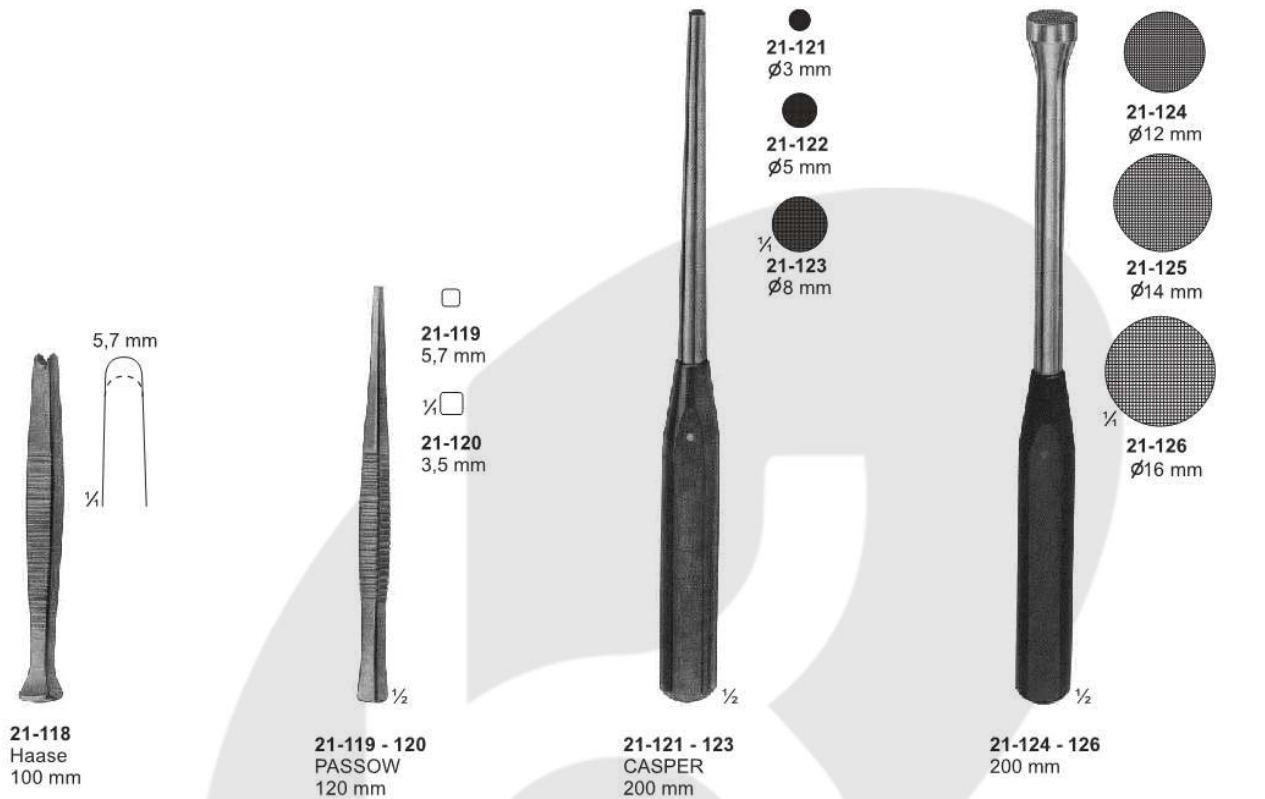

Osteotomes Chisels and Gouges



21-134
Mannerfelt
155 mm

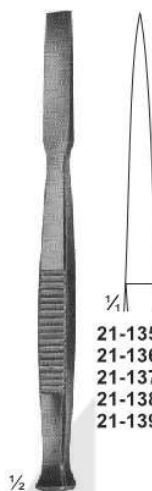

21-135 - 139
Osteotome
140 mm

- 21-135 4 mm
- 21-136 6 mm
- 21-137 8 mm
- 21-138 10 mm
- 21-139 12 mm

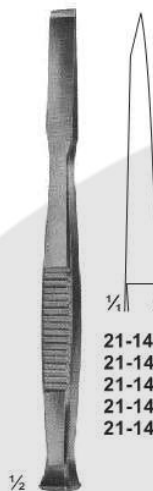

21-140 - 144
Chisels
140 mm

- 21-140 4 mm
- 21-141 6 mm
- 21-142 8 mm
- 21-143 10 mm
- 21-144 12 mm

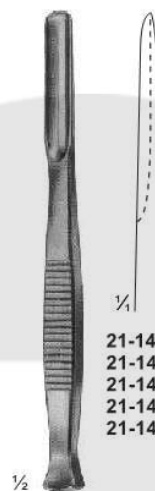

21-145 - 149
Gouges
140 mm

- 21-145 4 mm
- 21-146 6 mm
- 21-147 8 mm
- 21-148 10 mm
- 21-149 12 mm

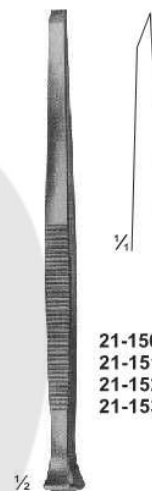

PARTSCH
21-150 - 153
Chisels
140 mm

- 21-150 3 mm
- 21-151 4 mm
- 21-152 5 mm
- 21-153 6 mm

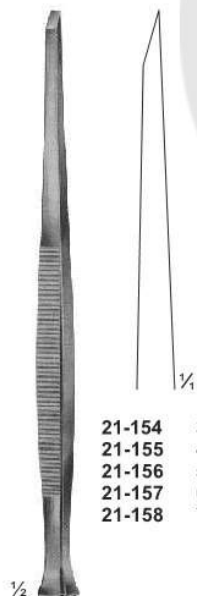

PARTSCH
21-154 - 158
Chisels
170 mm

- 21-154 3 mm
- 21-155 4 mm
- 21-156 5 mm
- 21-157 6 mm
- 21-158 7 mm

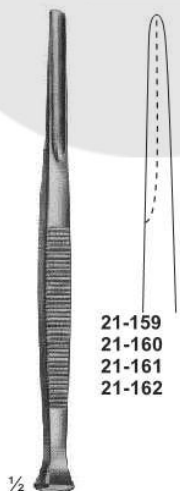

PARTSCH
21-159 - 162
Gouges
140 mm

- 21-159 3 mm
- 21-160 4 mm
- 21-161 5 mm
- 21-162 6 mm

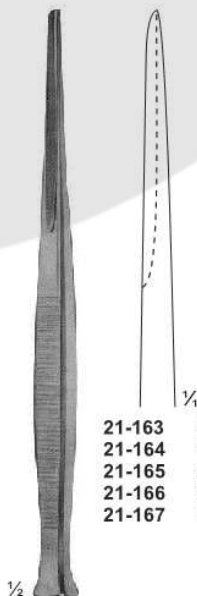

PARTSCH
21-163 - 167
Gouges
170 mm

- 21-163 3 mm
- 21-164 4 mm
- 21-165 5 mm
- 21-166 6 mm
- 21-167 7 mm



LUCAS
21-168 - 169
Chisels
160 mm

- 21-168 4 mm
- 21-169 6 mm



LUCAS
21-170 - 171
Gouges
160 mm

- 21-170 3 mm
- 21-171 5 mm

Osteotomes Chisels and Gouges

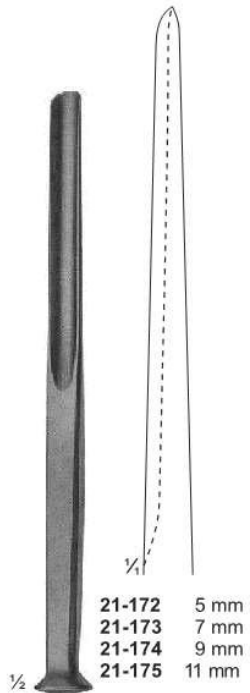

ALEXANDER
21-172 - 175
Gouges
170 mm

- 21-172 5 mm
- 21-173 7 mm
- 21-174 9 mm
- 21-175 11 mm



LAMBOTTE
21-176 - 181
Osteotome
125 mm

- 21-176 4 mm
- 21-177 6 mm
- 21-178 8 mm
- 21-179 10 mm
- 21-180 12 mm
- 21-181 15 mm

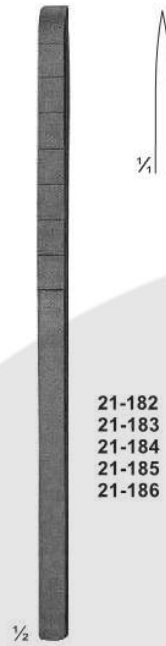

COTTLE
21-182 - 186
Osteotome with depth
markings
180 mm

- 21-182 4 mm
- 21-183 6 mm
- 21-184 8 mm
- 21-185 10 mm
- 21-186 12 mm

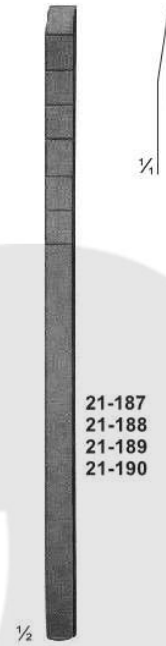

COTTLE
21-187 - 190
Chisel-Osteotomes
with depth markings
180 mm

- 21-187 4 mm
- 21-188 7 mm
- 21-189 9 mm
- 21-190 12 mm



COTTLE
21-191
Fishtail Chisel,
with protected ends
180 mm



STILLE
21-192 - 196
Chisels
205 mm

- 21-192 10 mm
- 21-193 12 mm
- 21-194 15 mm
- 21-195 20 mm
- 21-196 25 mm

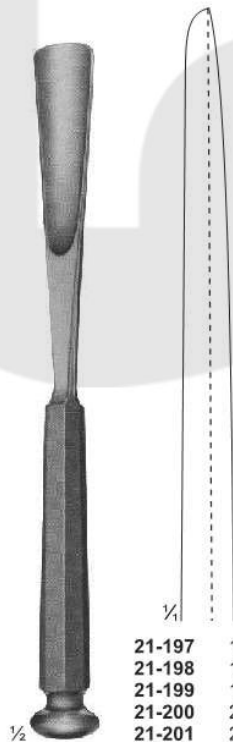

STILLE
21-197 - 201
Gouges
205 mm

- 21-197 10 mm
- 21-198 12 mm
- 21-199 15 mm
- 21-200 20 mm
- 21-201 25 mm

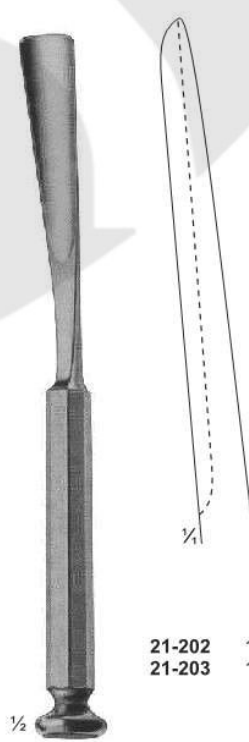

WALTER
21-202 - 203
Osteotomes
gouges for taking
grafts from the rib
205 mm

- 21-202 10 mm
- 21-203 15 mm

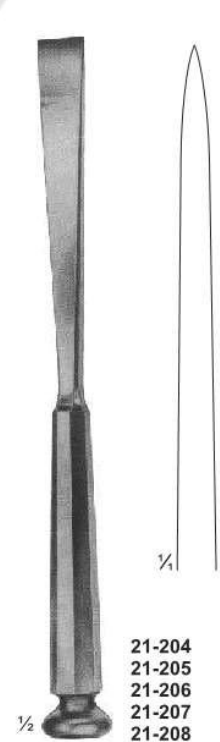

STILLE
21-204 - 208
Osteotomes
205 mm

- 21-204 8 mm
- 21-205 12 mm
- 21-206 15 mm
- 21-207 20 mm
- 21-208 25 mm

Osteotomes



STILLE
21-209 - 213
Osteotomes
205 mm

STILLE
21-214 - 218
Osteotomes, curved
205 mm

LAMBOTTE
21-219 - 230
Osteotomes
245 mm

LAMBOTTE
21-231 - 236
Osteotomes, curved
245 mm

21-209	10 mm	21-214	10 mm	21-219	4 mm	21-231	8 mm
21-210	12 mm	21-215	12 mm	21-220	8 mm	21-232	13 mm
21-211	15 mm	21-216	15 mm	21-221	10 mm	21-233	18 mm
21-212	20 mm	21-217	20 mm	21-222	13 mm	21-234	25 mm
21-213	25 mm	21-218	25 mm	21-223	15 mm	21-235	30 mm
				21-224	18 mm	21-236	38 mm
				21-225	20 mm		
				21-226	25 mm		
				21-227	30 mm		
				21-228	38 mm		
				21-229	44 mm		
				21-230	50 mm		

Osteotomes, Chisels and Gouges with HARTPRESS -handle

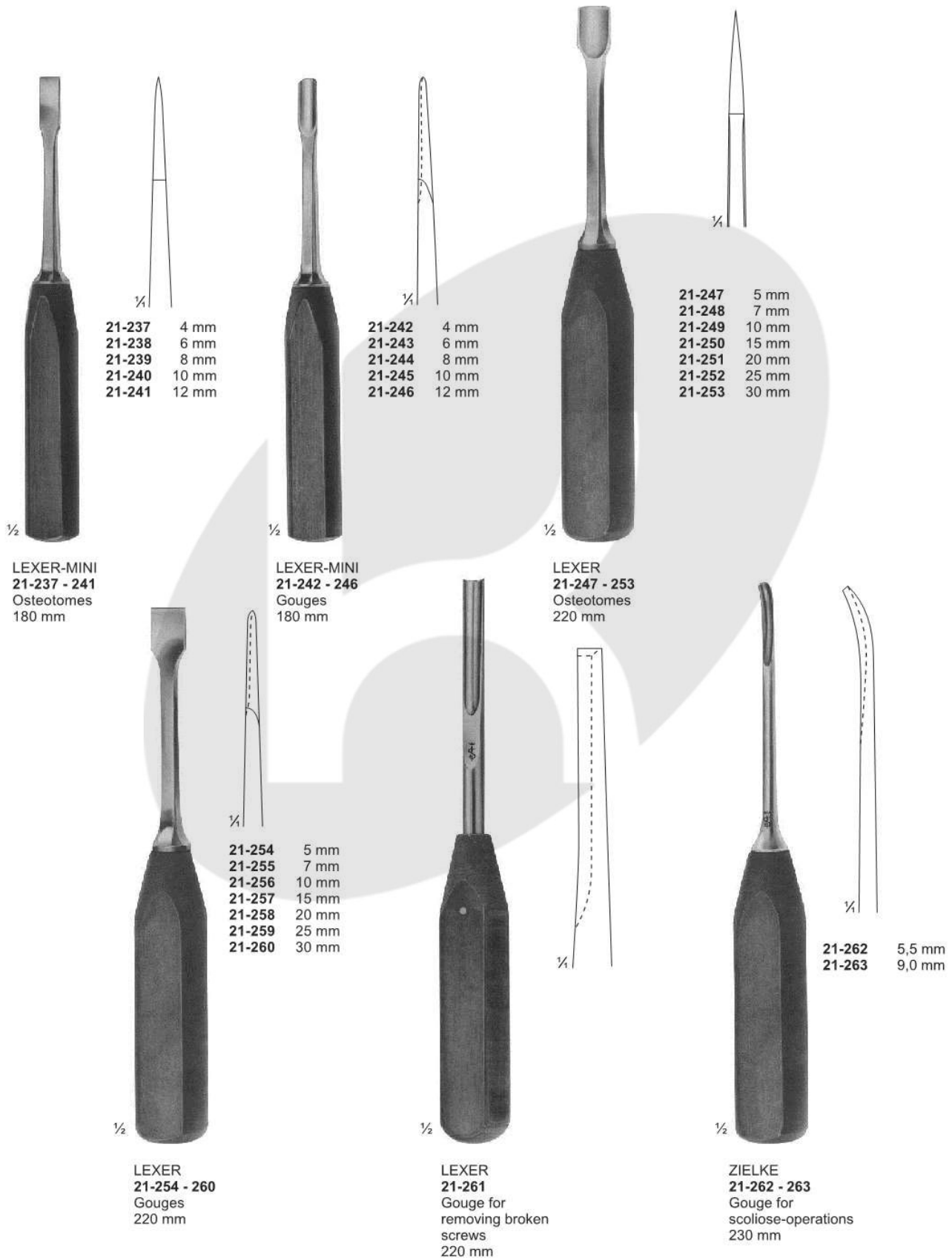

Osteotomes ,Chisels and Gouges with HARTPRESS -handle

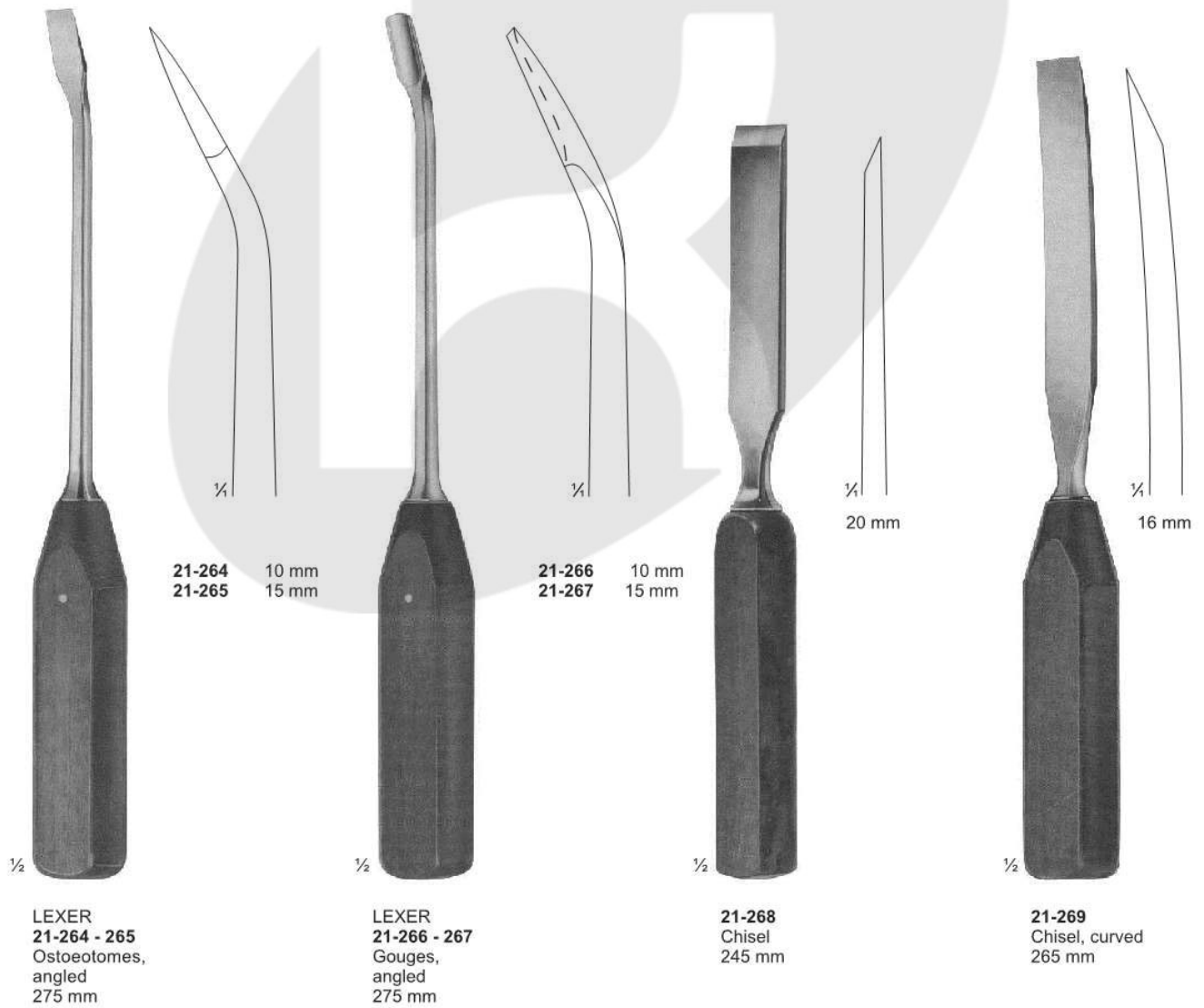

Reposition Forceps

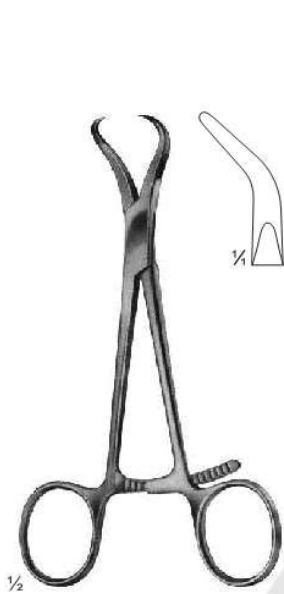

22-101
Reposition forceps,
for small fragments
135 mm

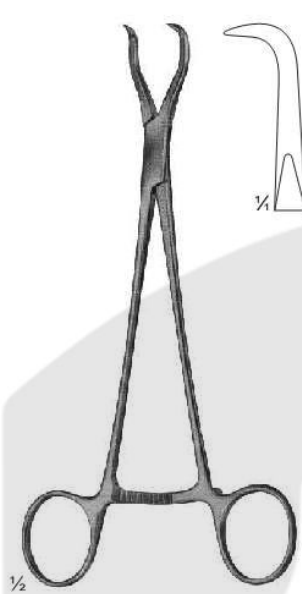

HAASE
22-102
Reposition forceps,
for mandibular
fractures
165 mm

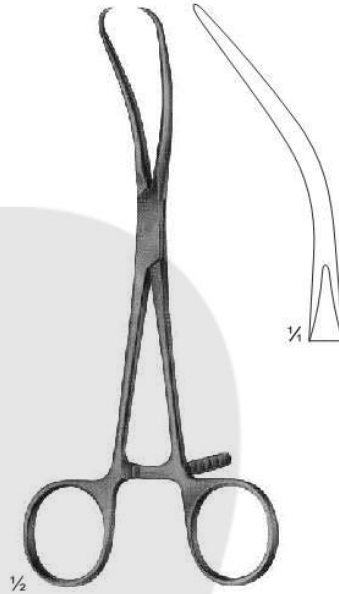

REILL
22-103
Reposition forceps,
170 mm



22-104
Reposition forceps
205 mm

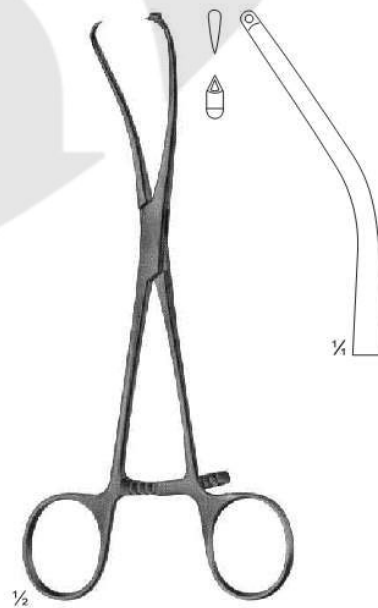

MEYER
22-105
Reposition forceps
for fingers, with drill
guide for KIRSCHNER
wires up to diam. 1.0 mm
170 mm

Reposition Forceps, Bone Holding Forceps



22-106
Patella forceps
185 mm

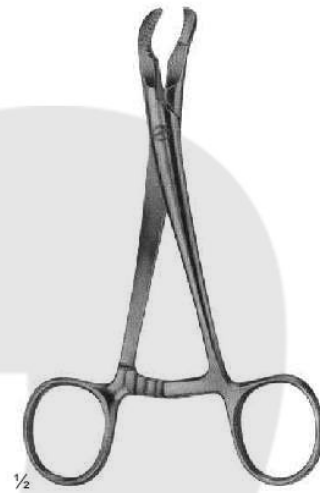

22-107
Forceps with
ratchet fixation
140 mm



22-108
Forceps with
thread fixation
170 mm

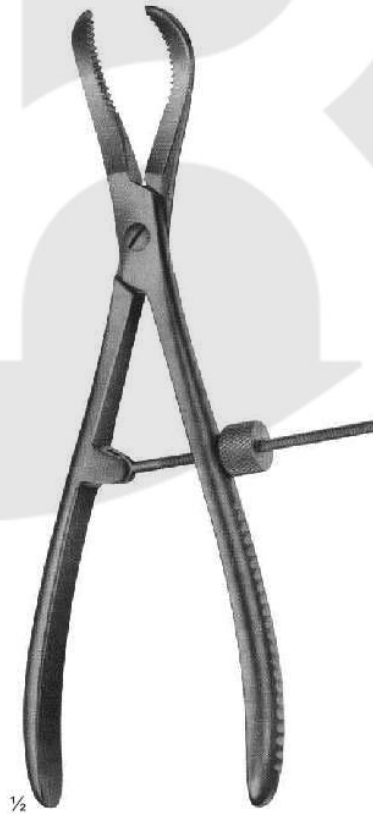

22-109
Forceps with
thread fixation
235 mm

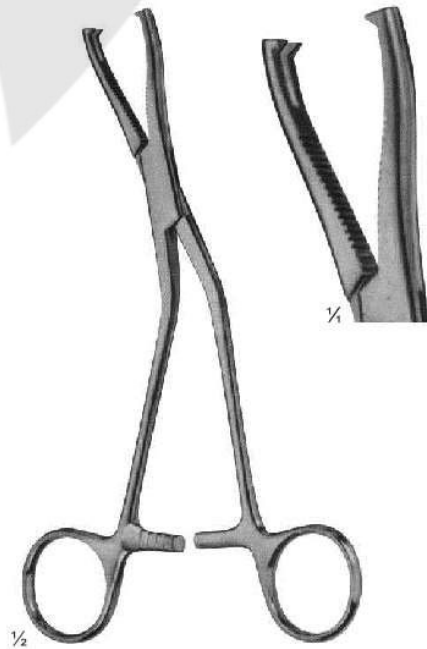

22-110
DINGMANN
185 mm

Bone Holding Forceps



22-111
Sequestrum
forceps
200 mm



22-112
VAN BUREN
Sequestrum
forceps
225 mm



22-113
LANGENBECK
Sequestrum
forceps
205 mm



22-114
FERGUSON
Sequestrum
forceps
205 mm

Bone Holding Forceps

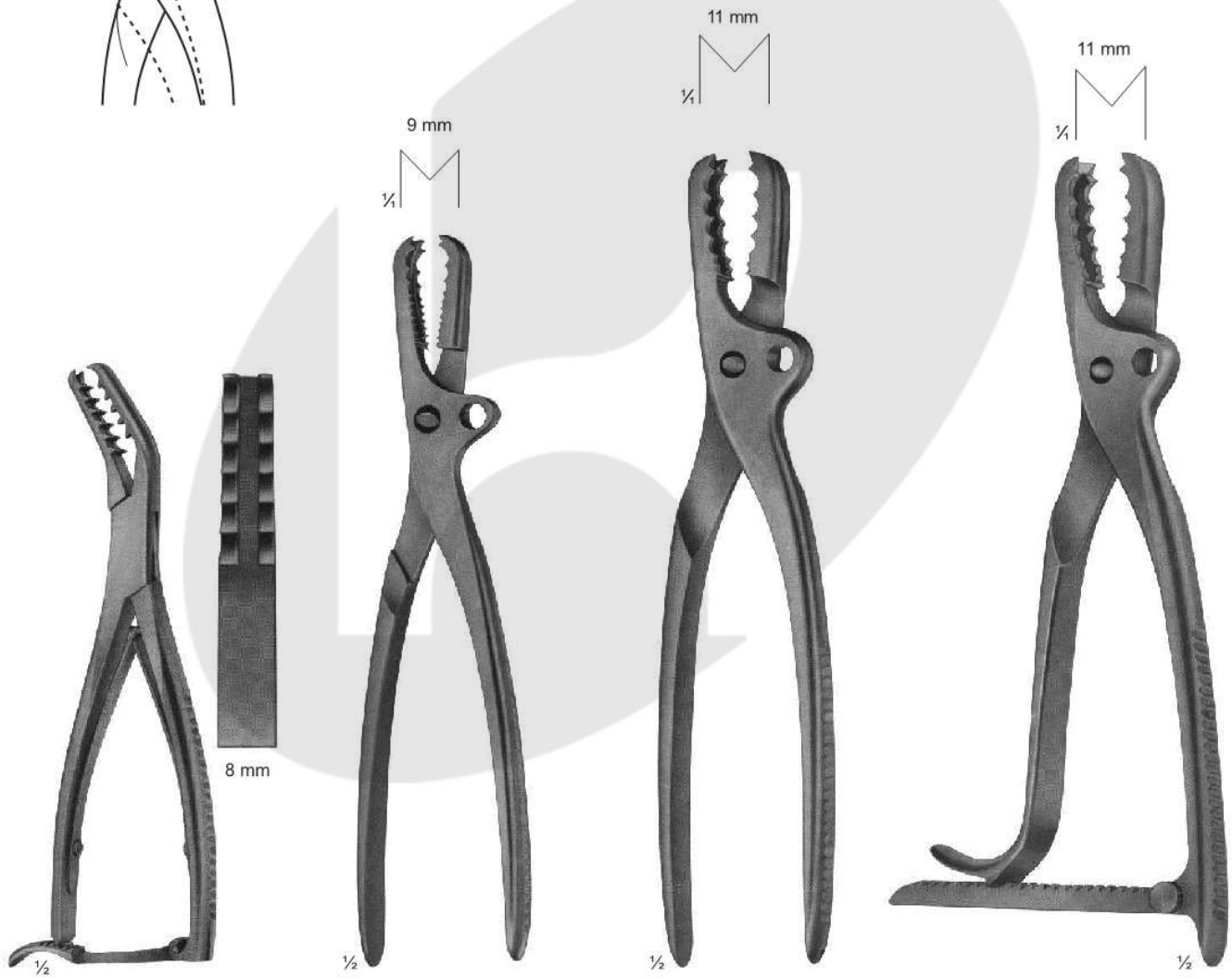
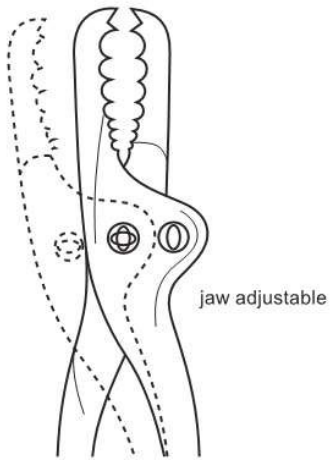

22-115
SEMB
190 mm

22-116
FARABEU
230 mm

22-117
FARABEU
255 mm

22-118
FARABEU-LAMBOTTE
255 mm

Bone Holding Forceps

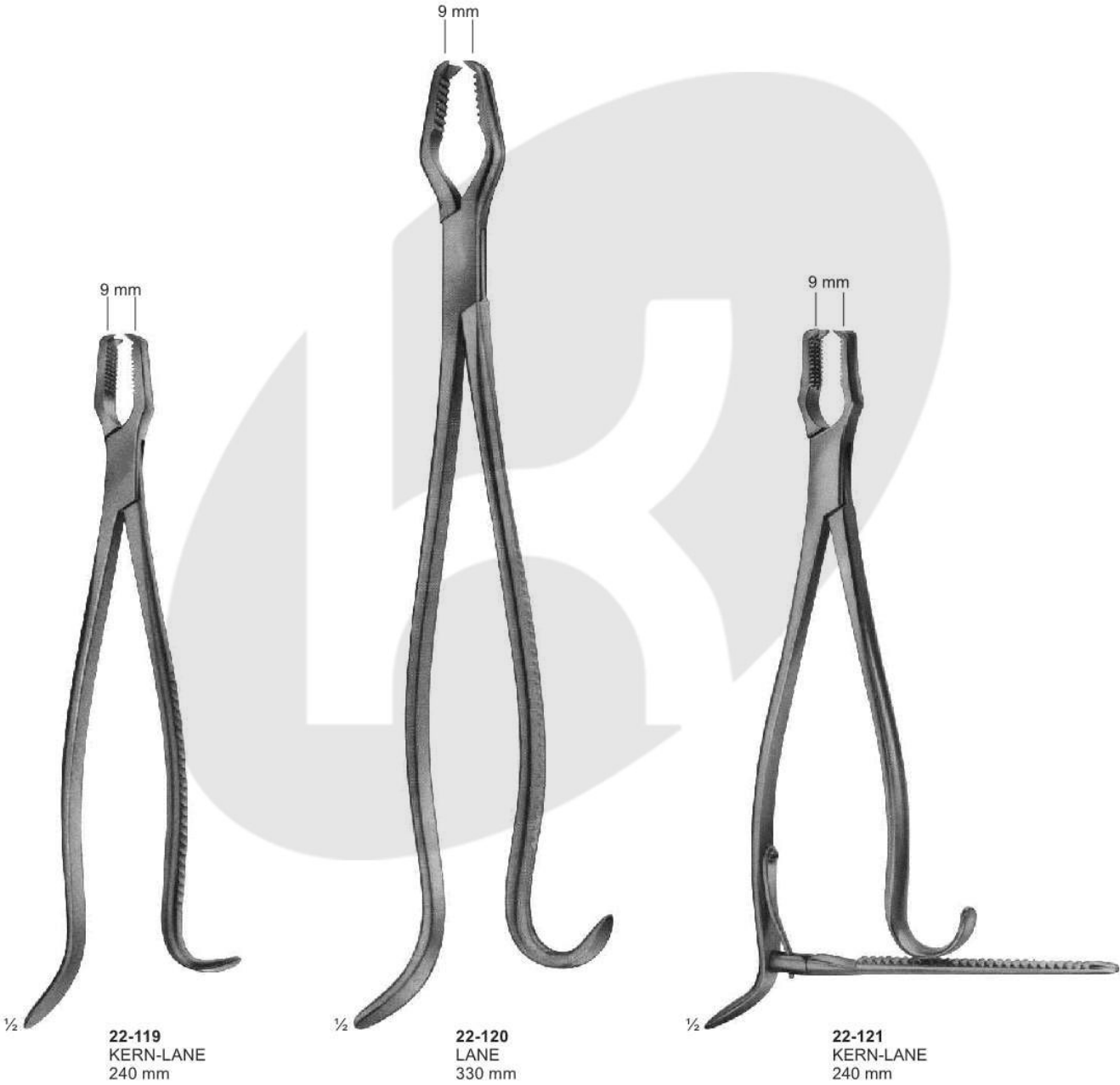

Bone Holding Forceps



22-122
LANE
320 mm

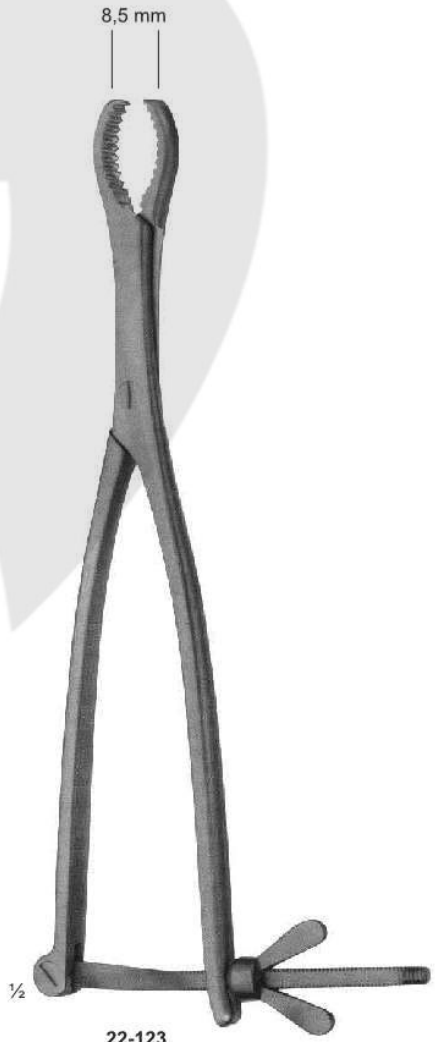

22-123
HEY GROVES
305 mm

Bone Clamps



22-133 - 134
LOWMAN
22-133 170 mm
22-134 205 mm



22-135
LOWMAN-GERSTER
210 mm



22-136
LOWMAN-HOGLUND
175 mm

Synovectomy-Rongeurs, Bone Rongeurs

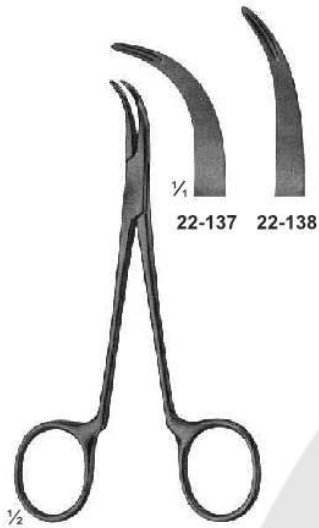

22-137 - 138
Synovcetomy rongeur
width of jaws 1.2 mm
130 mm

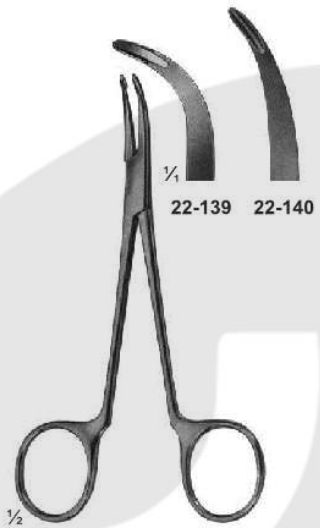

22-139 - 140
Synovcetomy rongeur
width of jaws 2.0 mm
130 mm

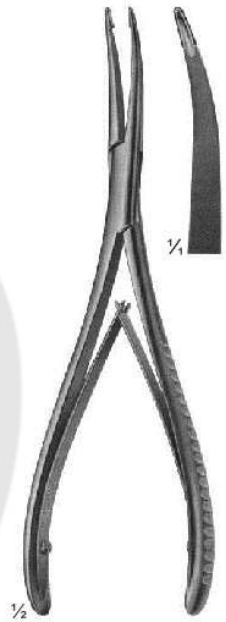

22-141
STELLBRINK
Synovcetomy rongeur
175 mm

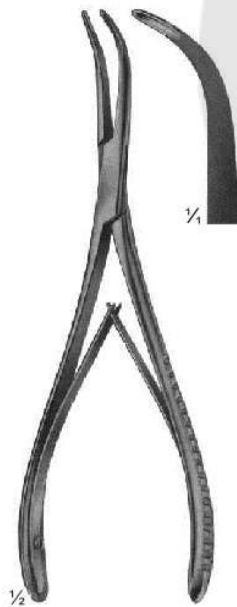

22-142
STELLBRINK
Synovcetomy rongeur
170 mm



22-143
LURE-FRIEDMANN
145 mm

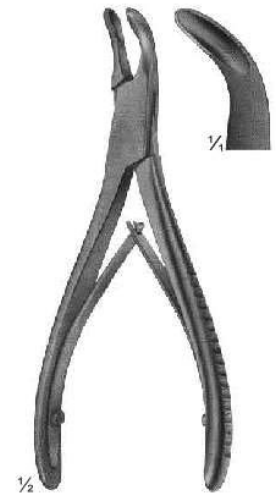

22-144
140 mm

Bone Rongeurs



22-145
LURE
150 mm

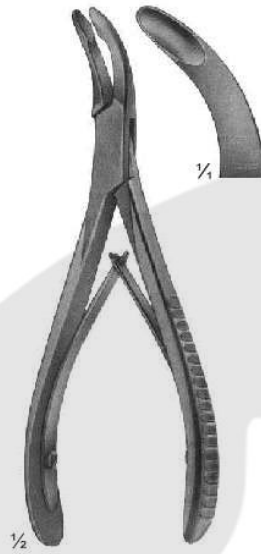

22-146
LURE
155 mm

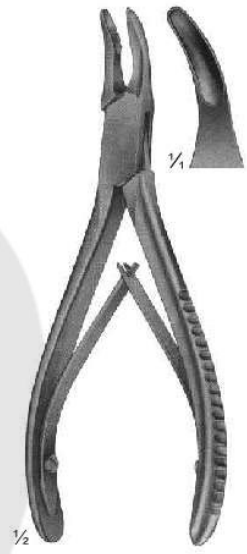

22-147
BLUMENTHAL
155 mm

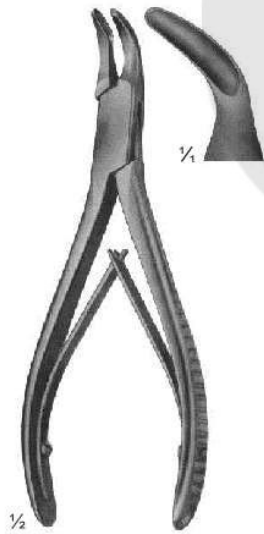

22-148
BLUMENTHAL
150 mm

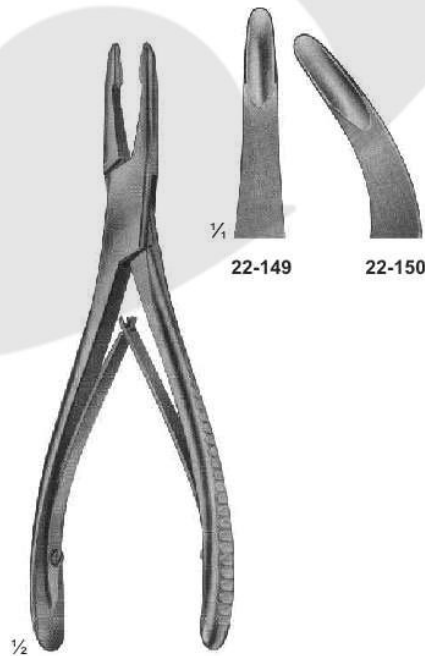

22-149 - 150
JANSEN
175 mm

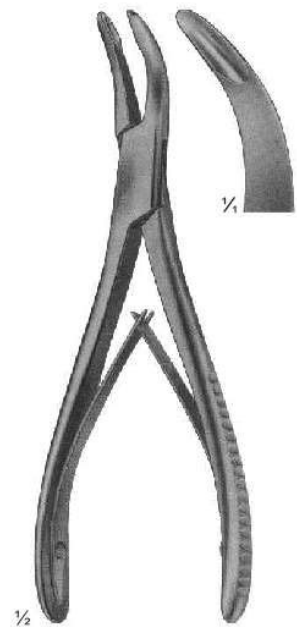

22-151
BANE-HARTMANN
175 mm

Bone Rongeurs

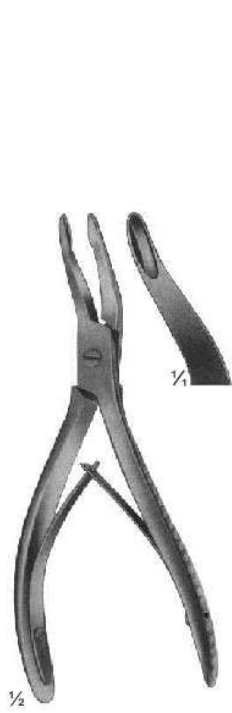

22-152
ALEXANDER
140 mm

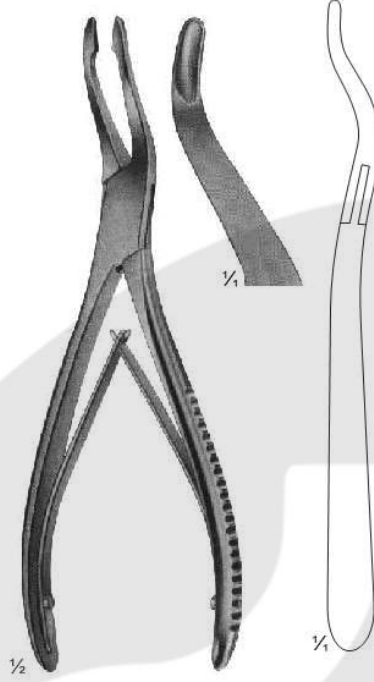

22-153
JANSEN
190 mm

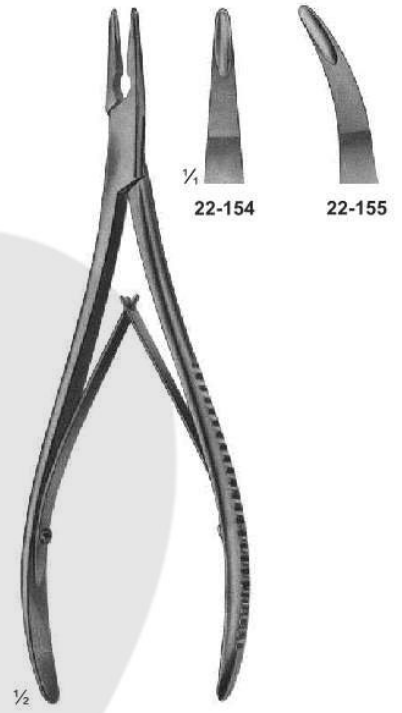

22-154 - 155
LEMPERT
200 mm

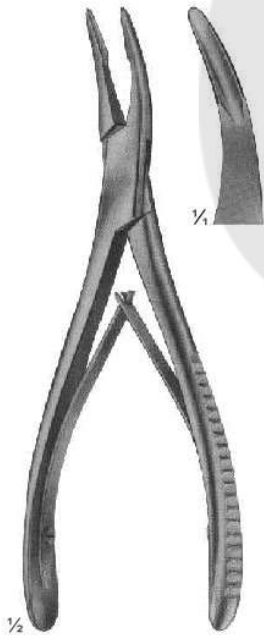

22-156
BEYER
180 mm

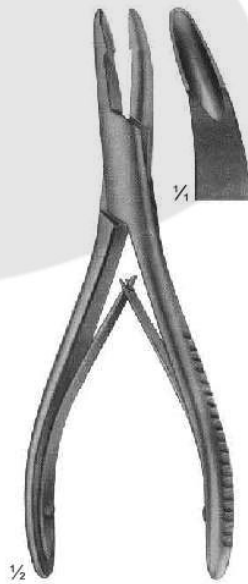

22-157
MEAD
165 mm

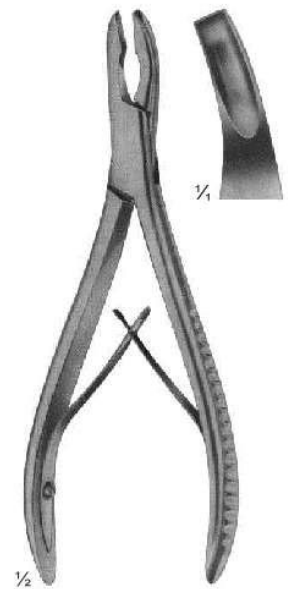

22-158
MEAD
165 mm

Bone Rongeurs

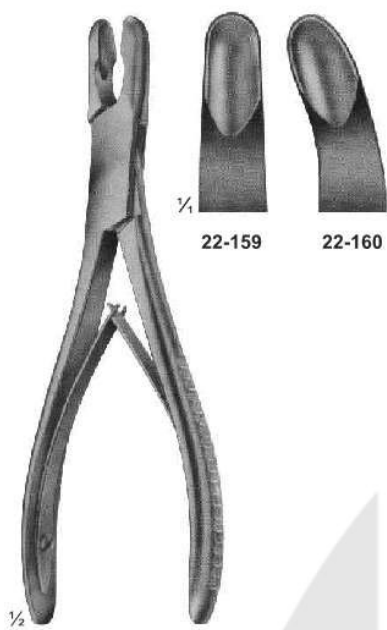

22-159

22-160

22-159 - 160
LURE
175 mm

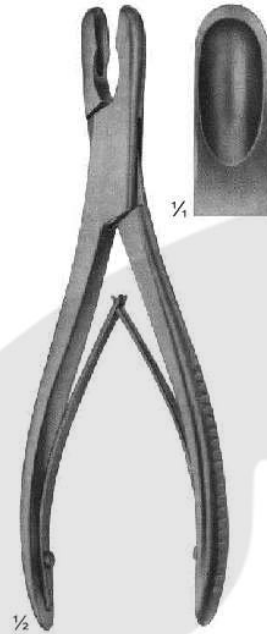

22-161
LURE
180 mm

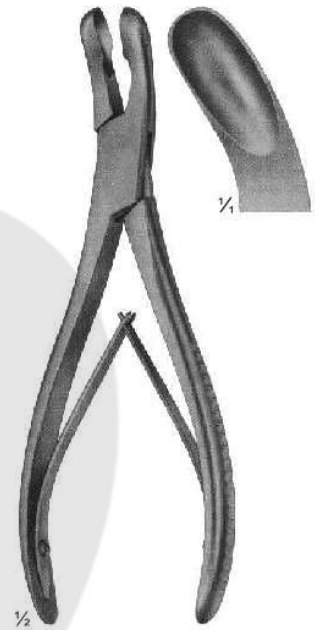

22-162
LURE
180 mm

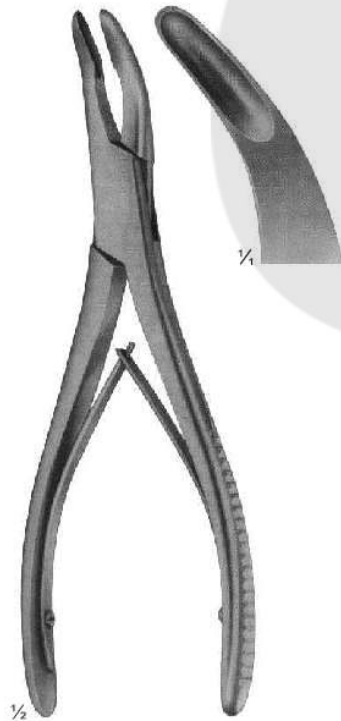

22-163
OLIVECRONA
205 mm

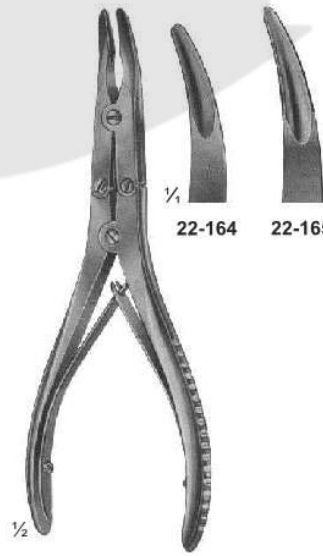

22-164 - 165
BOHLER
155 mm

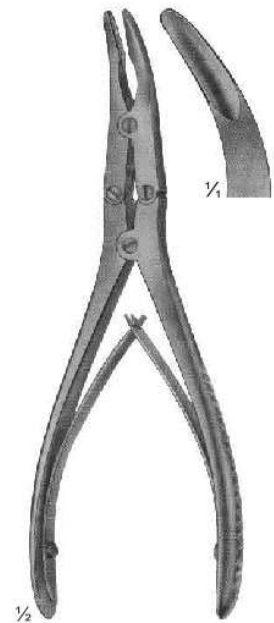

22-166
MARQUARTD
200 mm

Bone Rongeurs

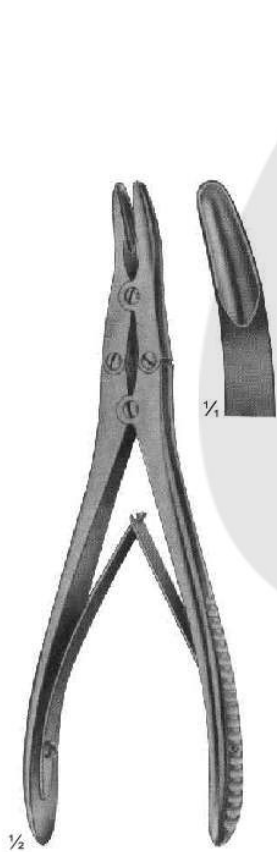

22-167
RUSKIN
190 mm

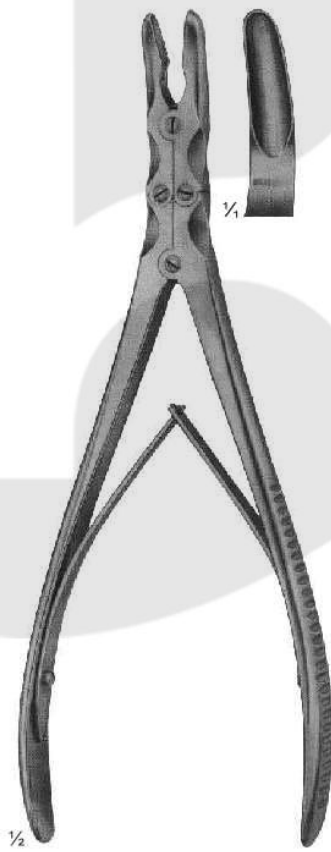

22-168
ROTTGEN-RUSKIN
240 mm

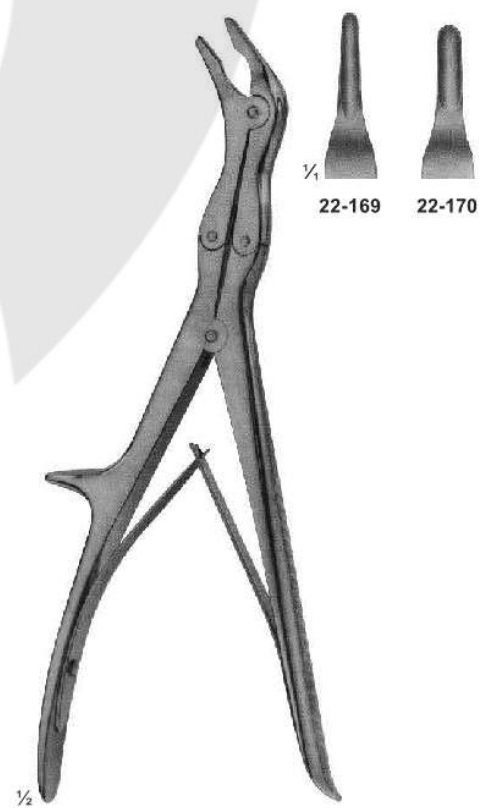

22-169 - 170
ECHLIN
230 mm

Bone Rongeurs

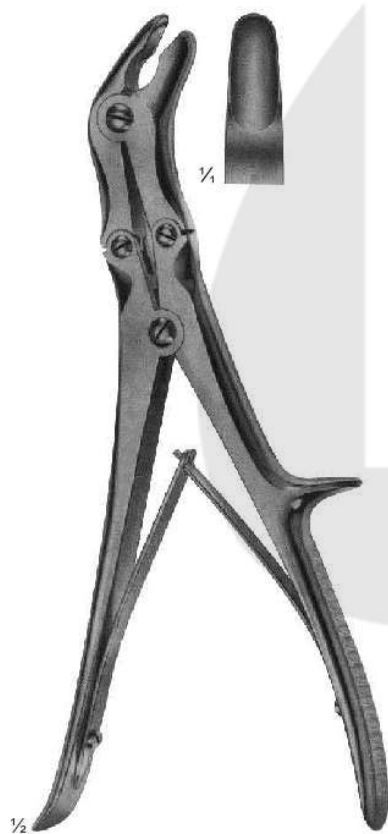

22-171
STILLE
235 mm



22-172
LEKSELL-STILLE
240mm



22-173
STILLE-RUSKIN
240mm

Bone Rongeurs

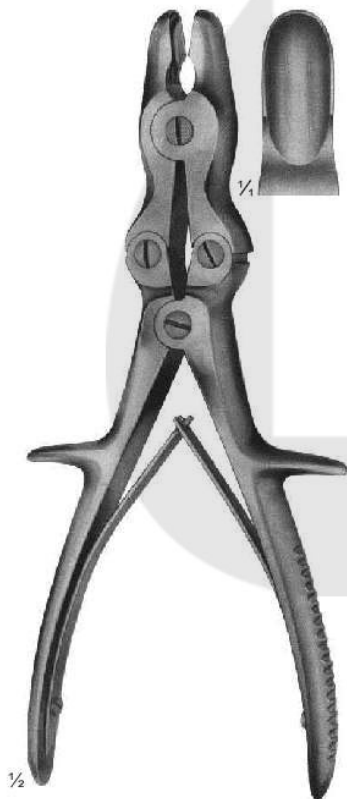

22-174
LURE-STILLE
225 mm



22-175
LURE-STILLE
225 mm

Vena-Cava Clamps

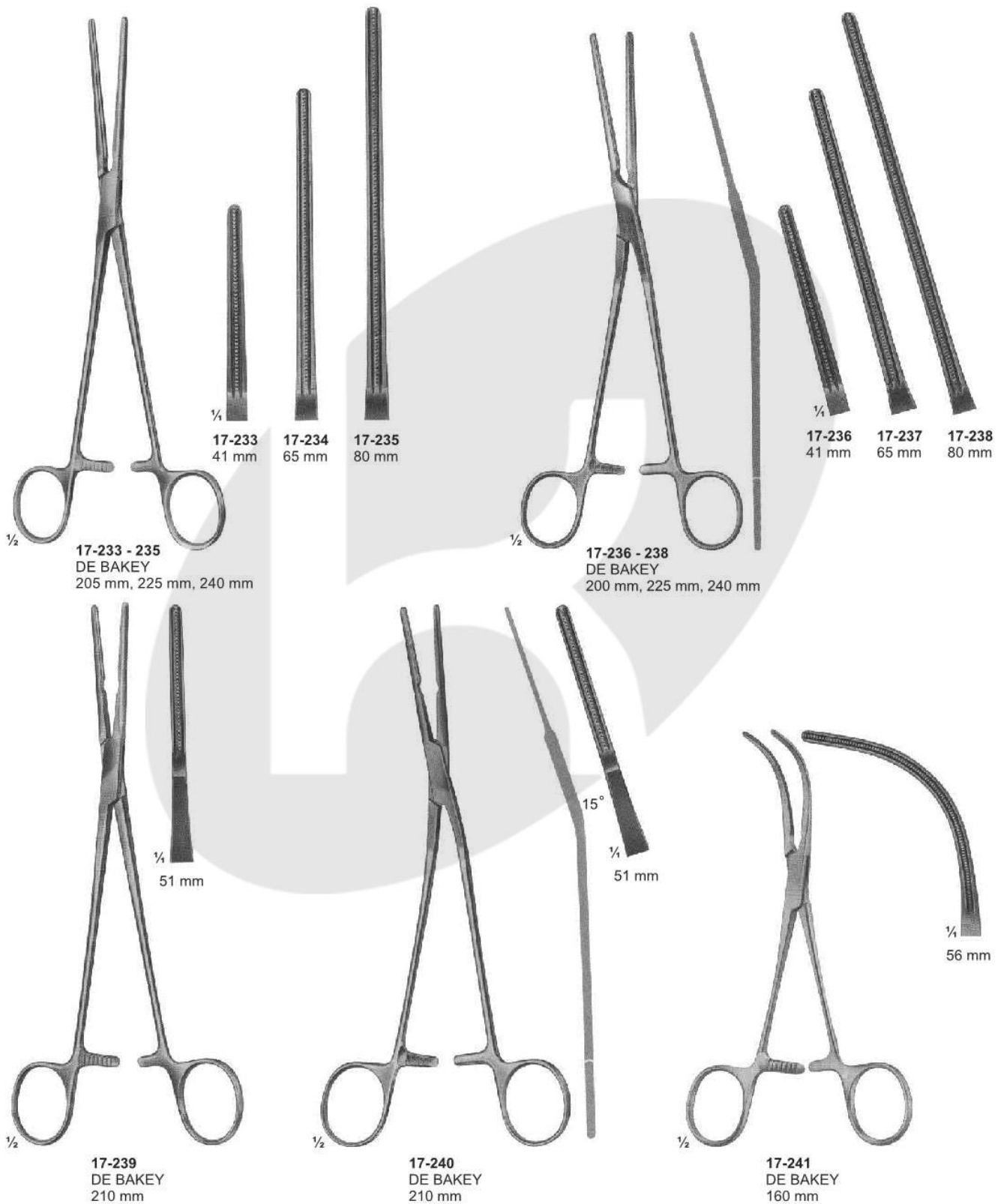

Bone Cutting Forceps

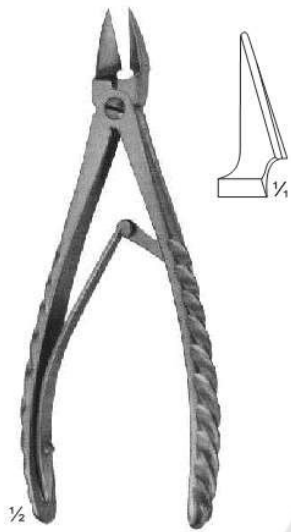

22-178
STAMM
150 mm

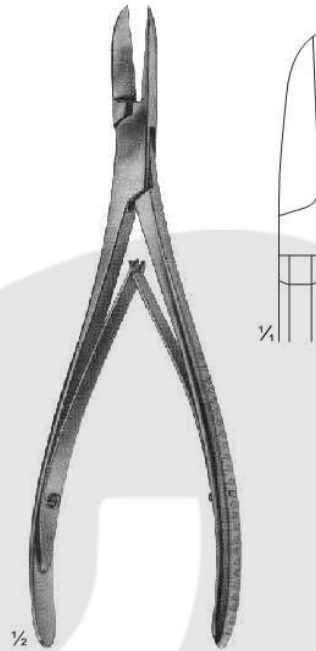

22-179
KAZANJIAN
185 mm



22-180
140 mm



22-181
170 mm



22-184
170 mm



22-185
200 mm



22-180 - 183
LISTON



22-182
200 mm



22-183
220 mm



22-184 - 186
LISTON



22-186
220 mm

Bone Cutting Forceps



22-187
BOHLER
145 mm



22-188
RUSKIN-LISTON
190 mm

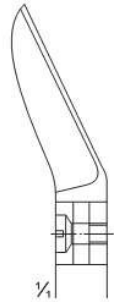

22-189
RUSKIN-LISTON
190 mm

Bone Cutting Forceps

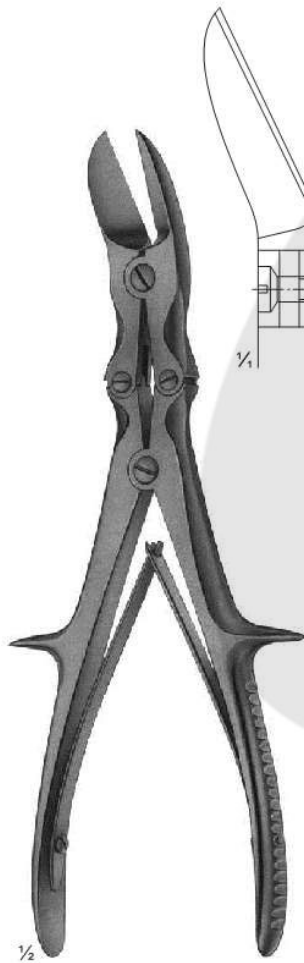

22-190
LISTON
curved on flat
240 mm

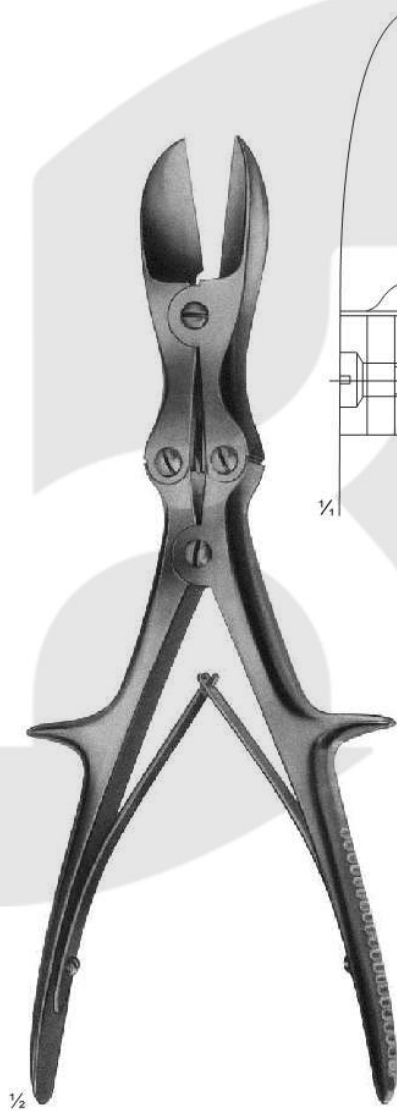

22-191
LISTON
straight
280 mm

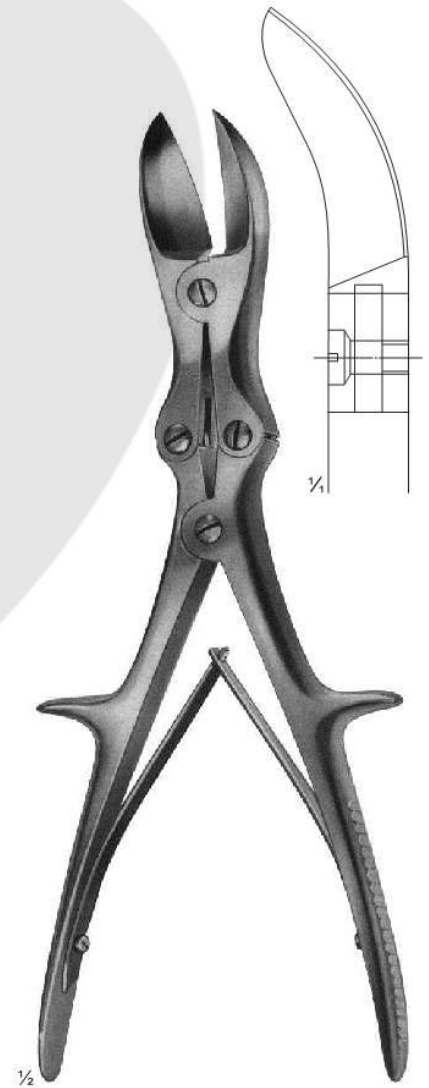

22-192
LISTON
curved on flat
280 mm

Bone Cutting Forceps

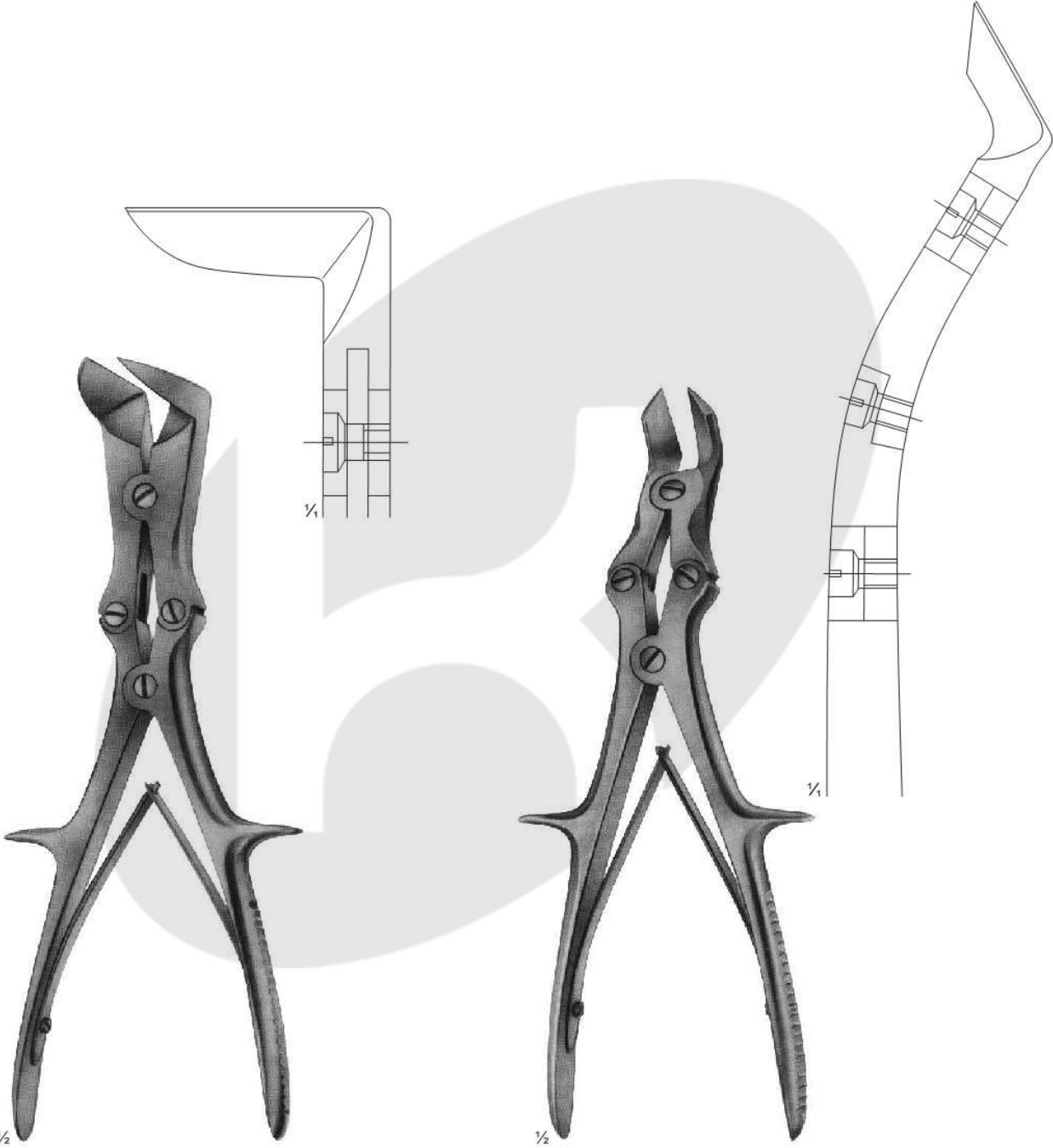

22-193
LISTON-STILLE
265 mm

22-194
LISTON-KEY-HORSLEY
(TUDOR EDWARDS)
255 mm

Meniscus-and Cartilage Forceps



22-195
BIRCHER
200 mm

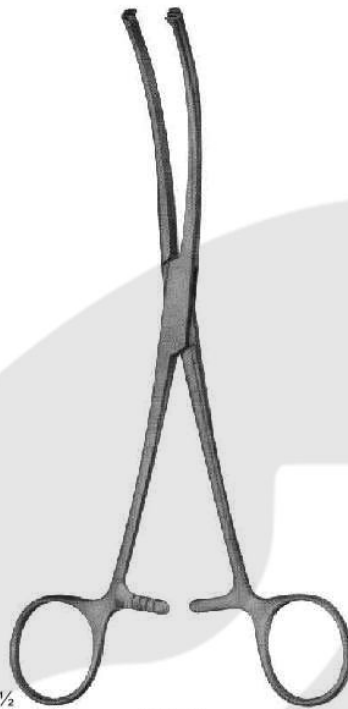

22-196
BIRCHER
200 mm

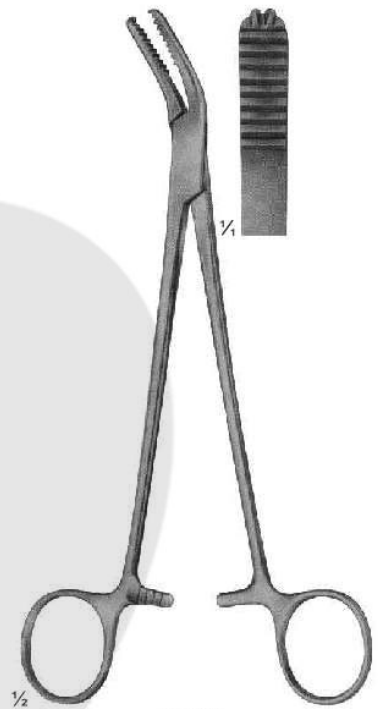

22-197
WELLER
200 mm

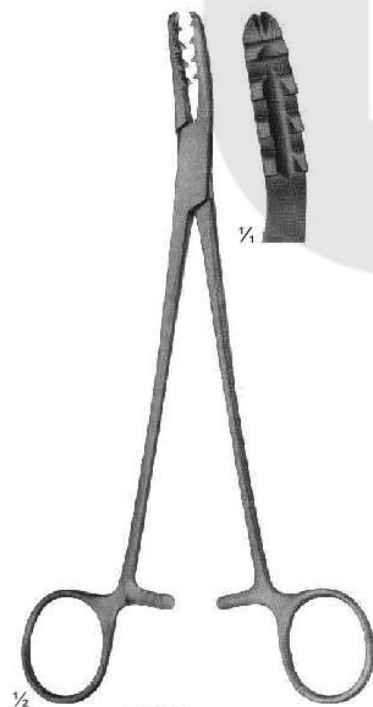

22-198
BIRCHER-GANSKE
200 mm

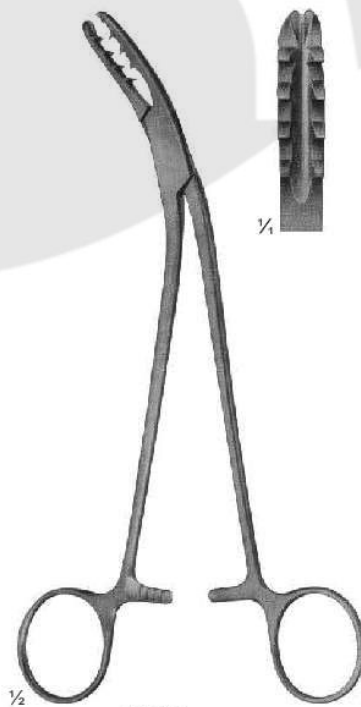

22-199
BIRCHER-GANSKE
200 mm



22-200
MARTIN
205 mm

Meniscus Knives



22-201
170 mm

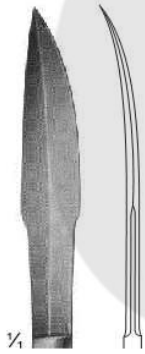

22-202
NEFF
215 mm



22-203
NEFF
215 mm



22-204
WAGNER
215 mm



Meniscus Knives

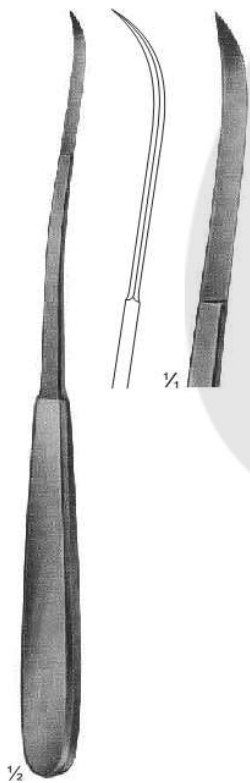

22-205
SALENIUS
220 mm

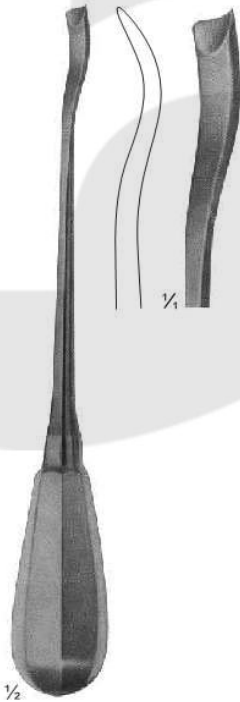

22-206
CHNAD.MODELL
200 mm

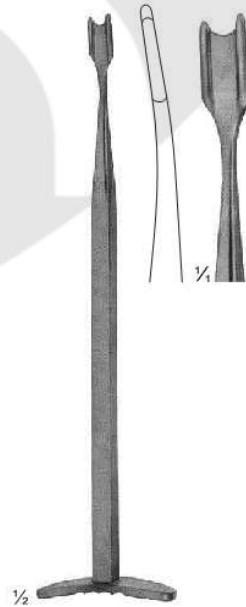

22-207
SMILLIE
170 mm

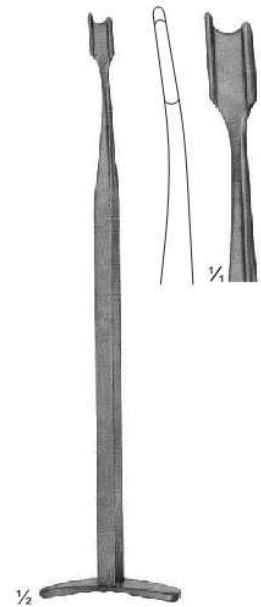

22-208
SMILLIE
170 mm

Wire Extension

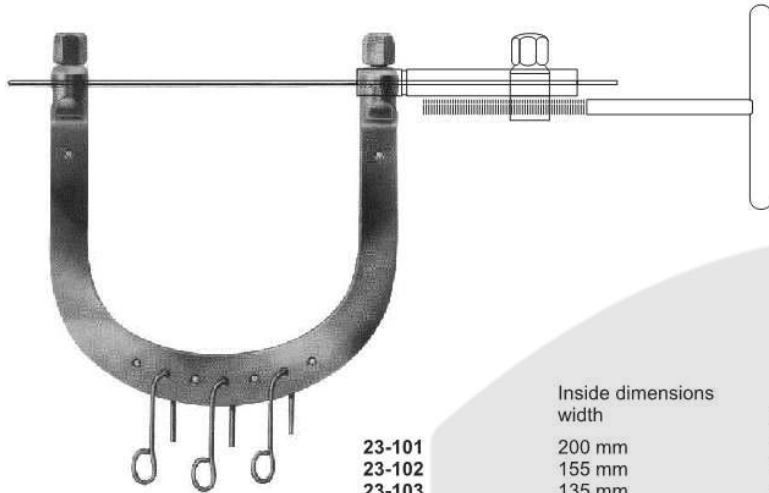

23-101 - 107
KIRSCHNER
 Wire traction bows,
 to be used with
 KIRSCHNER-wires
 up to 2.5 mm diam.,
 With 3 hooks,
 stainless steel

	Inside dimensions width	depth
23-101	200 mm	155 mm
23-102	155 mm	155 mm
23-103	135 mm	130 mm
23-104	120 mm	120 mm
23-105	105 mm	100 mm
23-106	95 mm	110 mm
23-107	95 mm	70 mm



23-108
 Wrench, double - ended,
 for wire traction bows

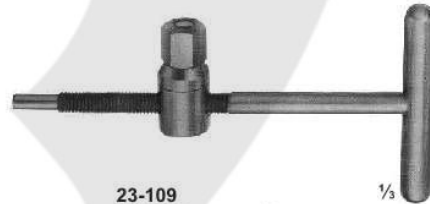

23-109
 Wire tightener, with
 clamping jaws



23-110
 Traction hook only,
 large size



23-111
 Traction hook only,
 small size



23-112
 Fixation clamp, to secure clamping
 jaws of stainless steel

Wire Extension

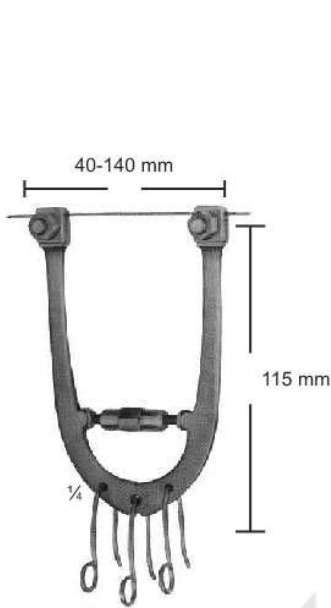

23-113
Wire traction bow, adjustable,
with 3 hooks, small size

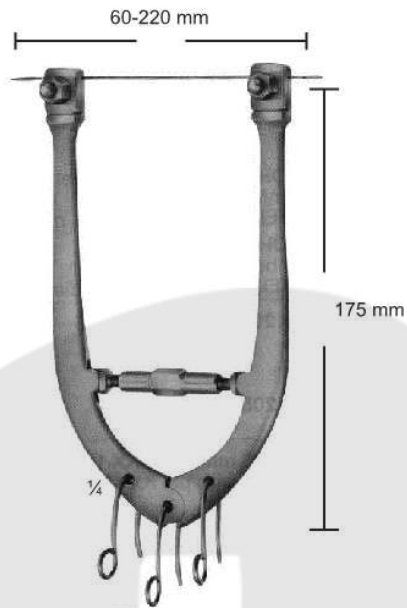

23-114
Wire traction bow, adjustable,
with 3 hooks, large size

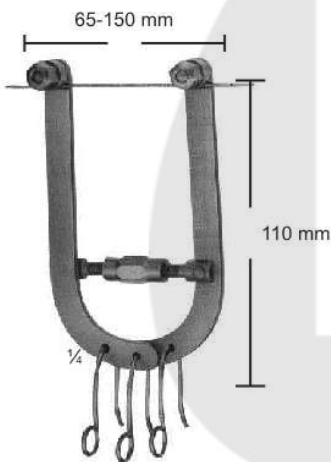

23-115
Wire traction bow, adjustable,
with 3 hooks, large size for
elbow and calcaneus, for
adolescents



23-116 105 mm
23-117 160 mm
23-118 200 mm

23-116 1,6 mm
23-117 2,0 mm
23-118 2,5 mm

23-116 - 118
KIRSCHNER
Wire traction bow, modified
adjustable in with width, holds wire
securely, with 1 hook



23-119
Fixation disc, slotted

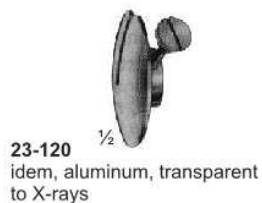

23-120
idem, aluminum, transparent
to X-rays

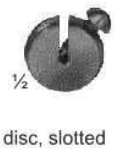

23-121
Fixation disc, slotted



23-122
Screw driver, for above
fixations discs

Traction Bows, Distractor

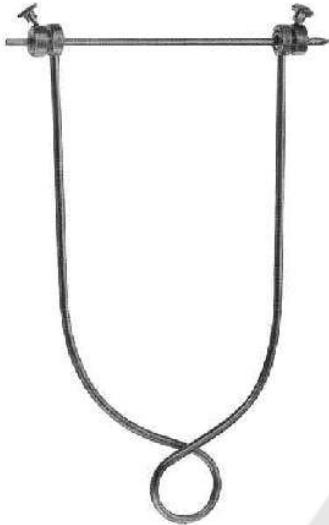

23-123 - 130
Screw driver, for above fixations discs

Steinmann pins, 4 mm daim.	Steinmann pins, 5 mm daim.
23-123 with pin	16x9cm Arm
23-124 without pin	23-129 without
23-125 with pin	21x11cm Arm
23-126 without pin	23-130 without
23-127 with pin	21x15cm Arm
23-128 without pin	

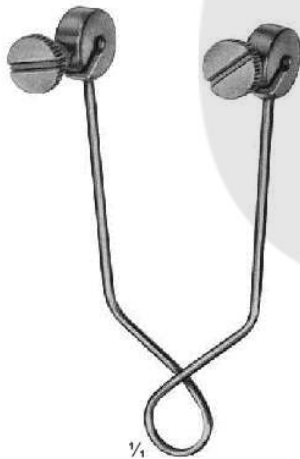

23-131
SCHWARZ
Traction bow for fingers,
to be used with **KIRSCHNER-**
wire up to 1.6 mm diam.

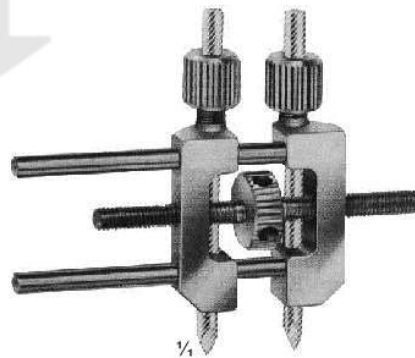

23-132
Small distractor
as a repositioning device for
distraction and compression of small bones,
for wires with 3.0 mm diam.

STEINMANN Pins



23-133 - 147
STEINMANN
triangular shaft ended and trocar point

Length	4,0 mm	5,0 mm
80 mm	23-133	
100 mm	23-134	
120 mm	23-135	
140 mm	23-136	
150 mm	23-137	23-143
160 mm	23-138	
180 mm	23-139	23-144
200 mm	23-140	23-145
210 mm	23-141	
250 mm	23-142	23-146
300 mm		23-147



¼

23-148
Protection cap
for 4,0 mm STEINMANN Pins



¼

23-149
Protection cap
for 5,0 mm STEINMANN Pins

Drilling Chucks



1/2

23-150
REILL
Drilling chuck,
cannulated,
for shanks from
2.0 - 2.5 mm diam
115 mm



1/2

23-151
Drilling chuck,
cannulated,
for shanks from
0.8 - 2.0 mm diam
150 mm



1/2

23-152
Drilling chuck,
cannulated,
for shanks up to
4.5 mm diam
with key
140 mm



1/2

23-153
LOUTE
Wire tightener, improved pattern,
with movable tip,
for wires up to 1.0 mm diam.
220 mm



1/2

23-154
Drilling chuck, cannulated,
for shanks up to 6.35 mm diam.,
To be tightened by hand
100 mm



1/2

23-155
Drilling chuck, cannulated,
for shanks up to 4.5 mm diam.,
And for triangular shaft width
across flats 4.7 mm



1/2

23-156
Drilling chuck, cannulated,
for shanks up to 6.35 mm diam.,
With key
160 mm

Cerclage Instruments

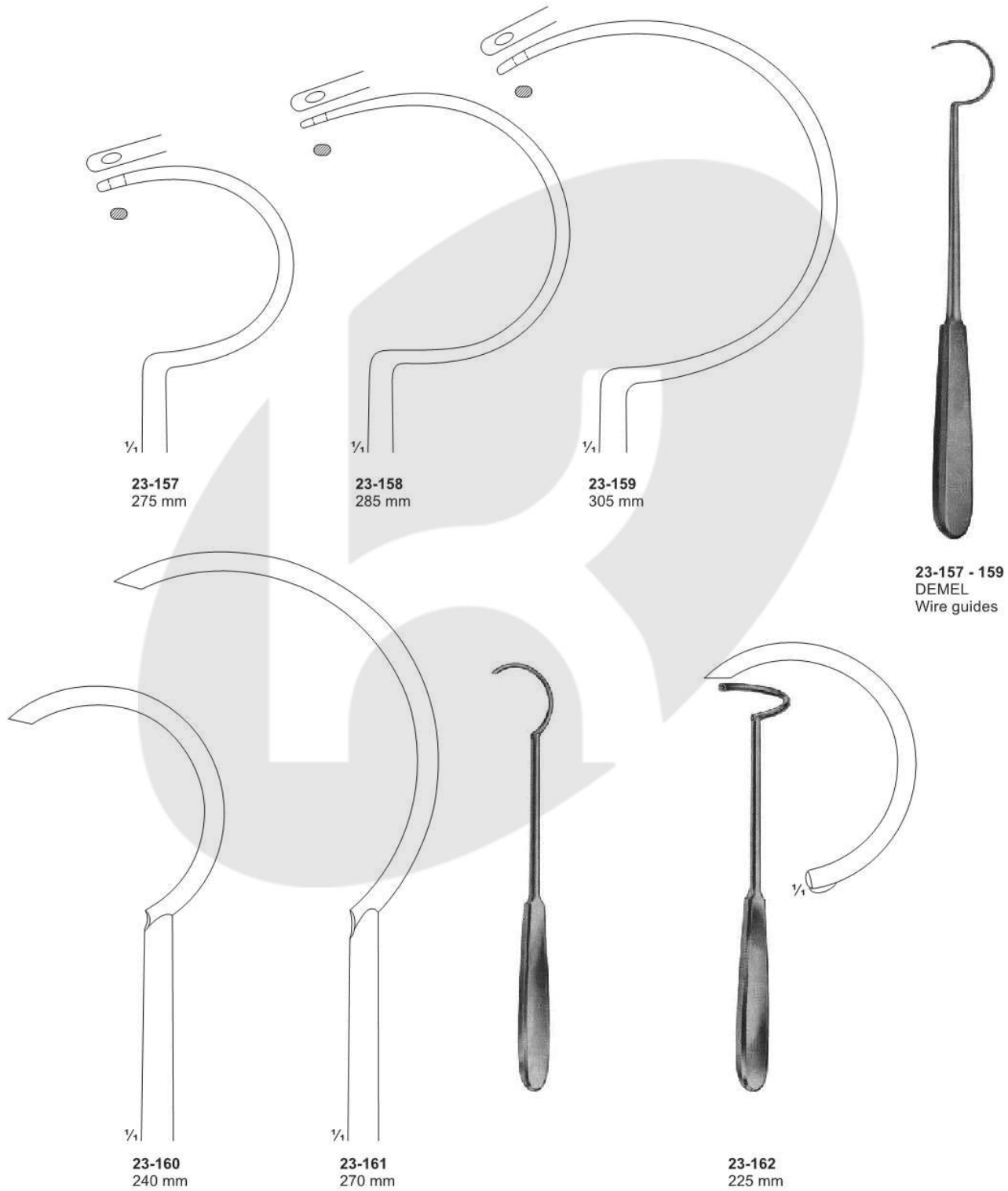

JORDAN instruments for subcutaneous Tibia Cerclage



23-163
JORDAN
Wire tightener



23-164
JORDAN
Wire twister
170 mm



23-165
JORDAN
Wire catcher
180 mm



23-166
JORDAN
Probe, cannulated
170 mm

Wire Holding forceps, Wire Tightening Pliers, Flat-nosed Pliers

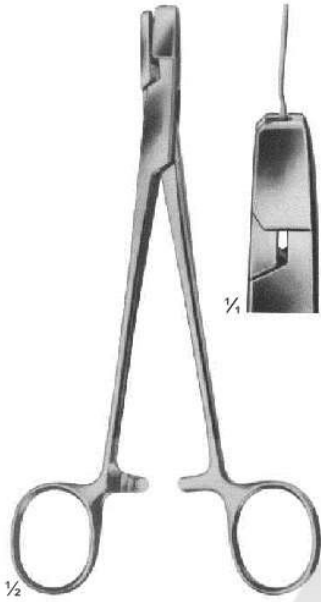

23-167
DUROGRIP
Holding forceps for cerclage wire, with lateral jaws to avoid wire slipping off
170 mm

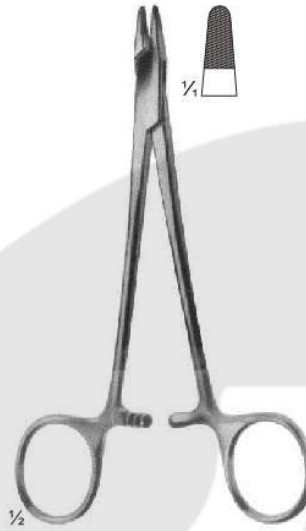

23-168
DUROGRIP
Wire, tightening pliers, Ligature pliers
150 mm



23-169
DUROGRIP
Wire, tightening pliers, Ligature pliers
150 mm



23-170
with serrated jaws
140 mm



23-171
one jaws smooth, one jaws serrated
140 mm



23-172
with serrated jaws
23-173
with longitudinal and transversal grooves
170 mm

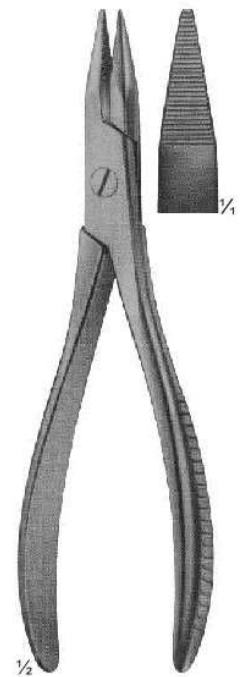

23-174
190 mm

Wire Holding forceps, Flat-nosed Pliers, Pliers for bending and cutting wires



23-175
130 mm

23-176
180 mm

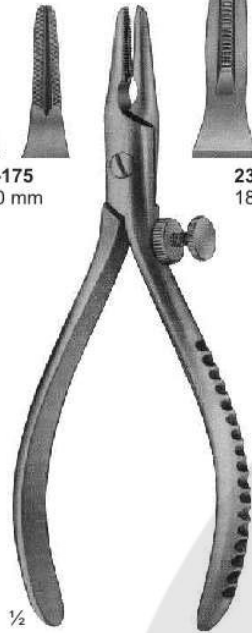

23-175 - 176
Extraction pliers
for boring wires

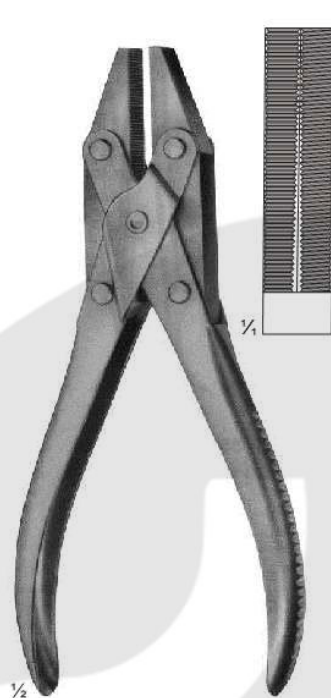

1/2

23-177
Flat-nosed pliers,
parallel
185 mm

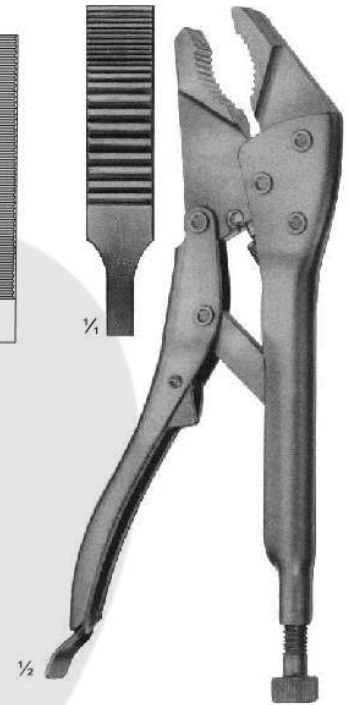

1/2

23-178
Vise grip
200 mm

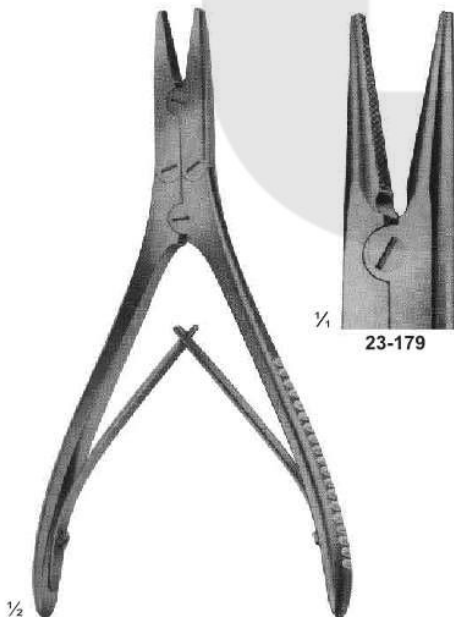

1/2

23-179 - 183
Round pliers
180 mm

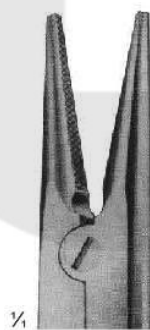

23-179



23-180



23-181



23-182



23-183

23-180
23-181 145 mm
23-182 180 mm
23-183 180 mm
Extraction pliers for wires

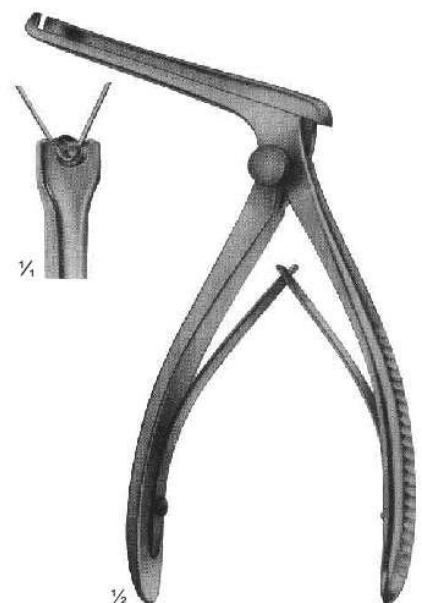

1/4

1/2

23-184
Bending pliers
for wires up to
1.8 mm diam.

Wire Cutters and wire Cutting Scissors

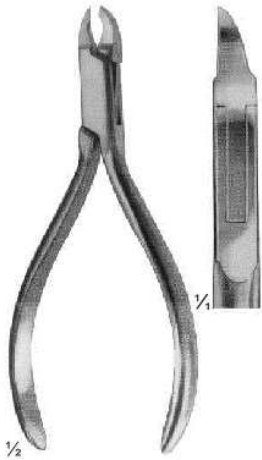

23-185
ANGLE
130 mm

for soft wire
up to diam.
for hard wire
up to diam.

23-186
DUROTIP
ANGLE
130 mm

0,5 mm 0,6 mm
0,3 mm 0,4 mm

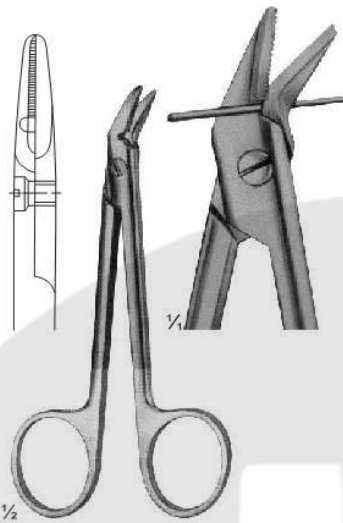

23-187
120 mm

for soft wire
up to diam.
for hard wire
up to diam.

23-188
DUROTIP
120 mm

1,2 mm 1,2 mm
0,8 mm 0,8 mm

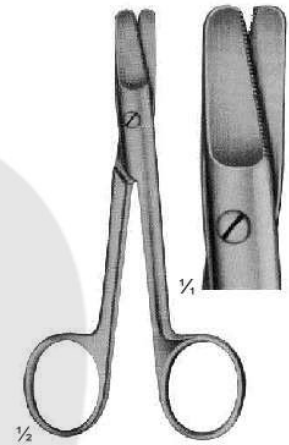

23-189
HARVEY
125 mm

0,4 mm
0,3 mm



23-190
150 mm

for soft wire
up to diam
for hard wire
up to diam

1,5 mm
1,0 mm



23-191
160 mm

1,5 mm
1,2 mm



23-192
140 mm

1,5 mm
1,0 mm

Wire Cutting Pliers, Lateral Cutting Action

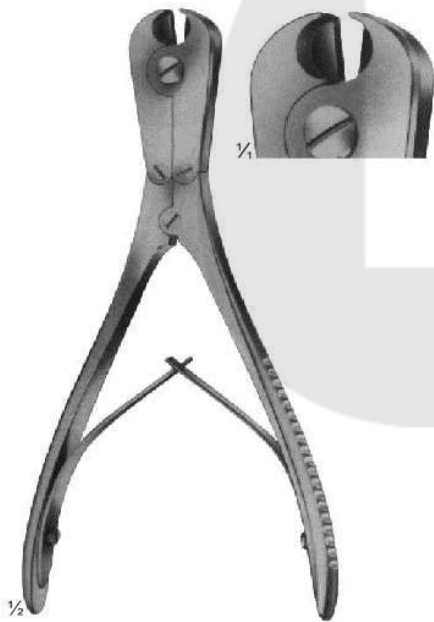

23-193
180 mm

for soft wire
up to diam. 2,0 mm
For hard wire 1,5 mm
up to diam
specially hardened
cutting edges, front
and lateral cutting
action



23-194
REILL
175 mm

for soft wire
up to diam. 2,0 mm
For hard wire 1,6 mm
up to diam
specially hardened
cutting edges, for
cutting off wires close
to the bone



23-195
235 mm

for soft wire
up to diam. 3,0 mm
For hard wire 2,2 mm
up to diam

Wire Cutting Pliers, Lateral and Front Cutting Action



1/2
23-196
 240 mm

for soft wire
 up to diam. 2,0 mm
 For hard wire
 up to diam 1,6 mm

1/2
23-197
 140 mm

for soft wire
 up to diam. 1,5 mm
 For hard wire
 up to diam 1,0 mm

1/2
23-198
 145 mm

for soft wire
 up to diam. 2,0 mm
 For hard wire
 up to diam 1,5 mm

1/2
23-199
 220 mm

for soft wire
 up to diam. 3,5 mm
 For hard wire
 up to diam 2,5 mm

Wire Cutting Pliers



Cutter for cutting off
KIRSCHNER wires,
Tibia head screws,
bolts, pins, up to 3 mm diam.

1/4

Durotip

23-200
320 mm

for soft wire
up to diam. 3,0 mm
For hard wire
up to diam 3,0 mm

23-201
Cutter for cutting off
KIRSCHNER wires,
Tibia head screws,
bolts, pins, up to 6 mm diam.
470 mm

Finger Nail Instruments

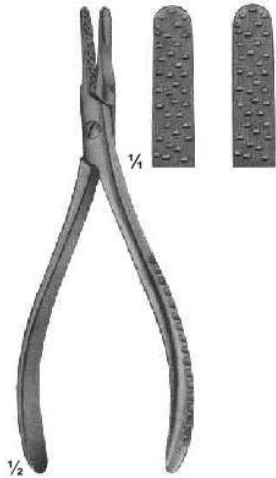

23-202
Nail extracting
forceps
135 mm



23-203
Nail extracting
forceps
145 mm

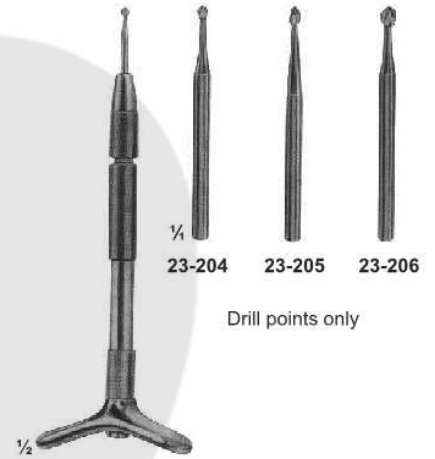

23-204 - 206
Finger nail drill
with 3 points

Drill points only

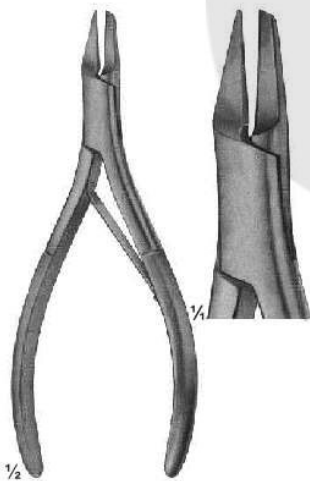

23-207
Nail splitting
forceps
135 mm

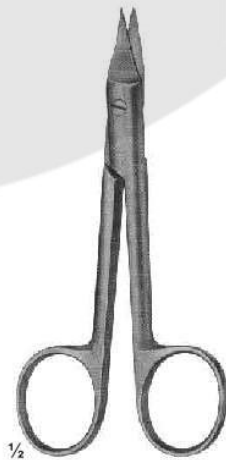

23-208
SYSTRUNK
Scissors, for splitting
finger nails
130 mm

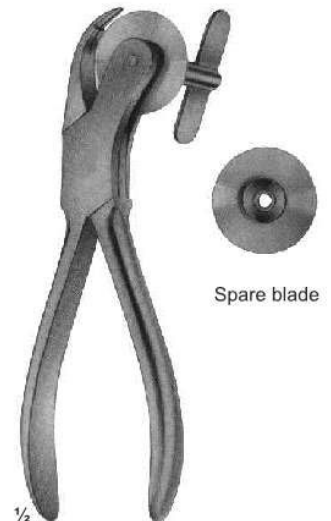

23-209
Finger ring saw
150 mm

Spare blade

Plaster Instruments



with ebony handle

24-101
HOPKINS
200 mm



1/2

24-102
ESMARCH
180 mm



1/2

24-103
ENGEL
160 mm



1/2

24-104 - 112

- | | | | |
|--------|-------|--------|-------------|
| 24-104 | black | 24-108 | yellow |
| 24-105 | red | 24-109 | white |
| 24-106 | blue | 24-110 | orange |
| 24-107 | green | 24-111 | lavender |
| | | 24-112 | bright pink |



1/2

24-113 - 121

- | | | | |
|--------|-------|--------|-------------|
| 24-113 | black | 24-117 | yellow |
| 24-114 | red | 24-118 | white |
| 24-115 | blue | 24-119 | orange |
| 24-116 | green | 24-120 | lavender |
| | | 24-121 | bright pink |

Plaster Scissors

For small plaster dressings

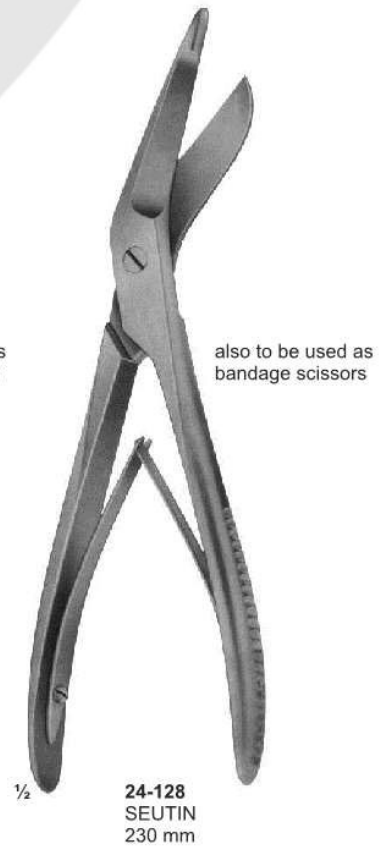
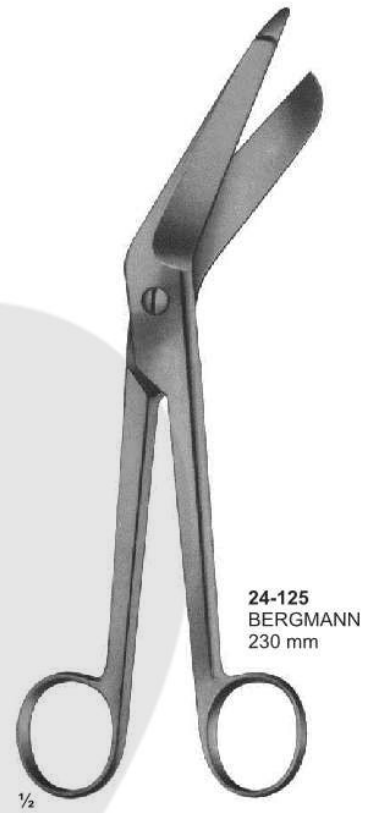
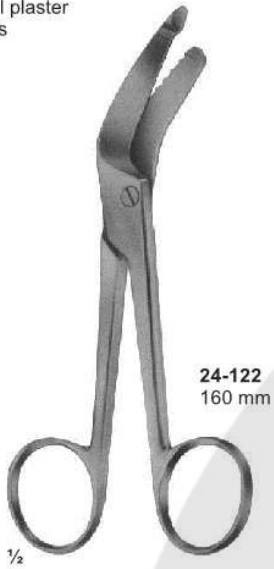

Plaster Shears

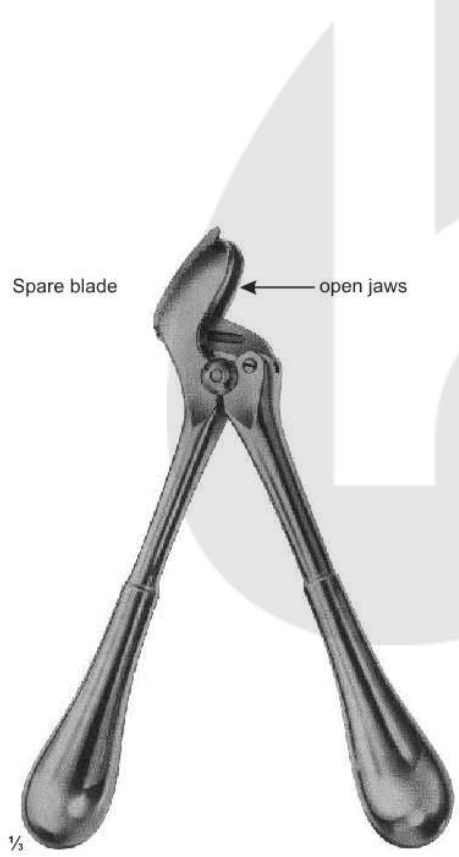

24-129
STILLE-AESCALAP
260 mm



24-130
STILLE-AESCALAP
360 mm

STILLE Plaster Shears

Blade with reinforced back



24-131
STILLE
230 mm

24-132
Spare blade



24-133
STILLE
370 mm

24-134
Spare blade

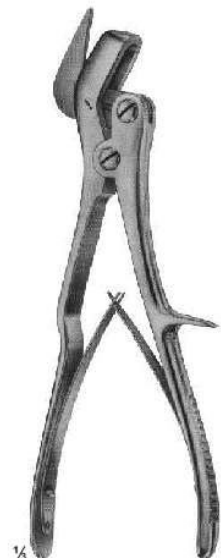

24-135
STILLE
240 mm

24-136
Spare blade

Plaster Spreader, Plaster Breakers



24-137
HENING
270 mm



24-138
MOD.USA
230 mm

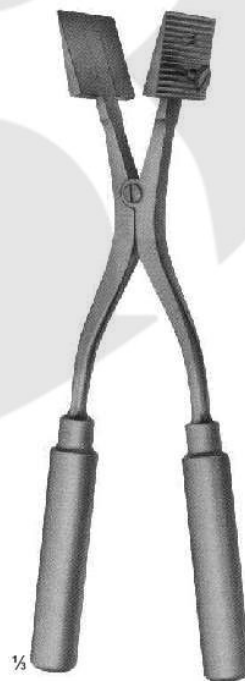

24-139
290 mm



with removable jaws



24-140 - 141
WOLFF
24-140 180 mm
24-141 240 mm

Vacuum Curettes for Aspiration Lipectomy, Suction Instruments



25-101 - 106
BIEMER
25-101 ø 4 mm
25-102 ø 6 mm
25-103 ø 8 mm
25-104 ø 10 mm
25-105 ø 12 mm
25-106 ø 14 mm
Curettes for aspiration lipectomy, graduated, slightly curved

25-107 - 108
BIEMER
25-107 ø 4 mm
25-108 ø 6 mm
Curettes for aspiration lipectomy, with three apertures, slightly curved malleable

25-109 - 111
BIEMER
25-109 ø 8 mm
25-110 ø 10 mm
25-111 ø 12 mm
Curettes for aspiration lipectomy, with three apertures, slightly curved malleable

25-112
For aspirating fluid from the excretory ducts of large glands and for keeping the operating area clear 170 mm

25-113
Trocar
For puncturing 150 mm

25-114
For clearing large quantities of fluid 190 mm

Suction Instruments



25-115
Trocar
For puncturing
170 mm



25-116
Hollow needle,
sharp
150 mm



25-117
double curved
For general
surgery
230 mm

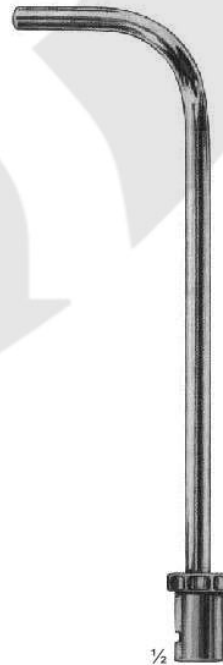

25-118
For tonsillectomy,
oral and laryngeal
operations
190 mm

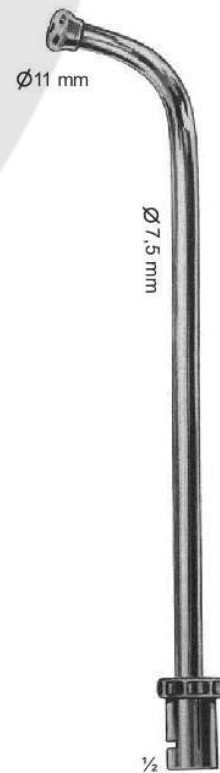

25-119
For tonsillectomy,
oral and laryngeal
operations
220 mm

Suction Instruments

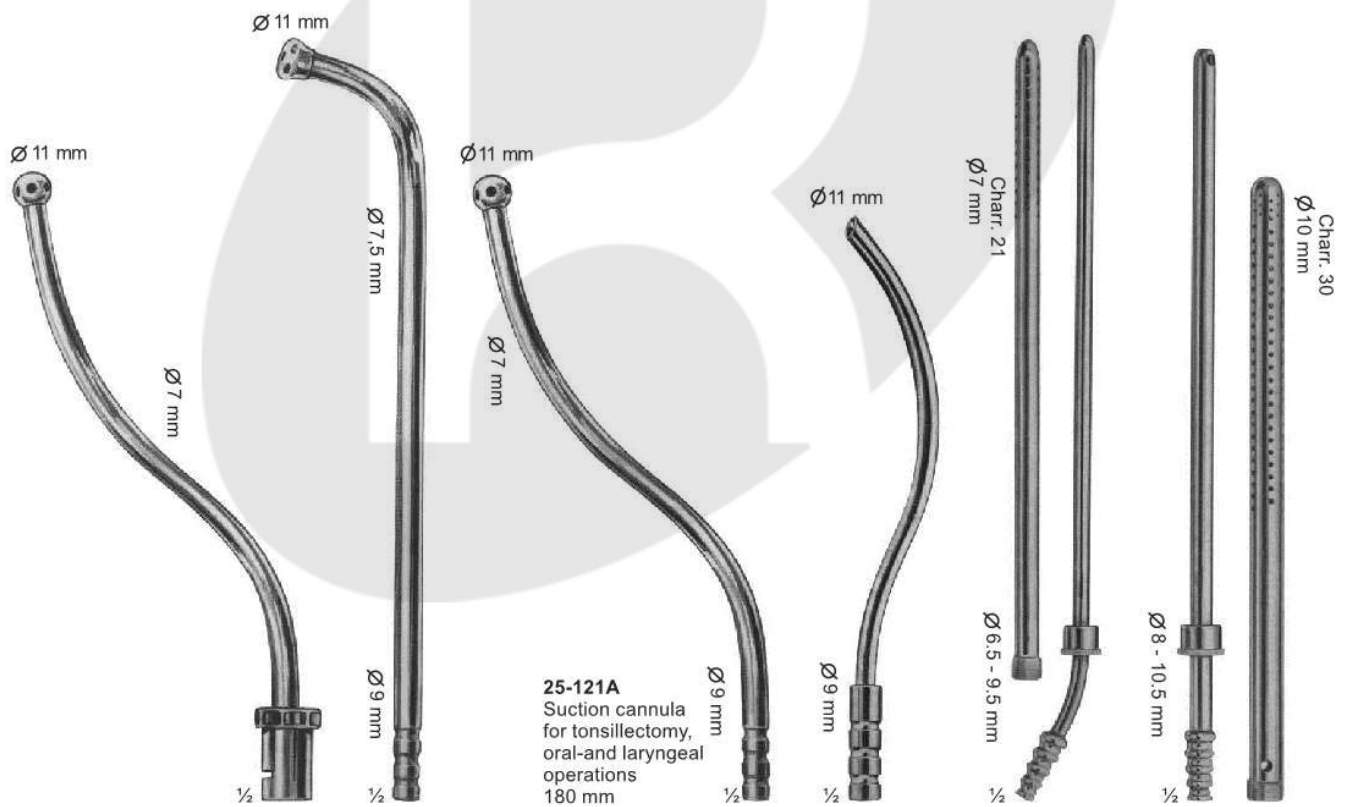

25-120
For tonsillectomy,
oral-and laryngeal
operations
180 mm

25-121
Suction cannula
for tonsillectomy,
oral-and laryngeal
operations
220 mm

25-121A
Suction cannula
for tonsillectomy,
oral-and laryngeal
operations
180 mm

25-122
S-shaped blunt cannula
for aspirating fluid from
the excretory ducts of
large glands and for
keeping the operations
area clear
170 mm

25-123
POOL
Suction cannula,
with outer tube
to be screwed of
225 mm

25-124
POOL
Suction cannula,
with outer tube
to be screwed of
225 mm

Suction Instruments

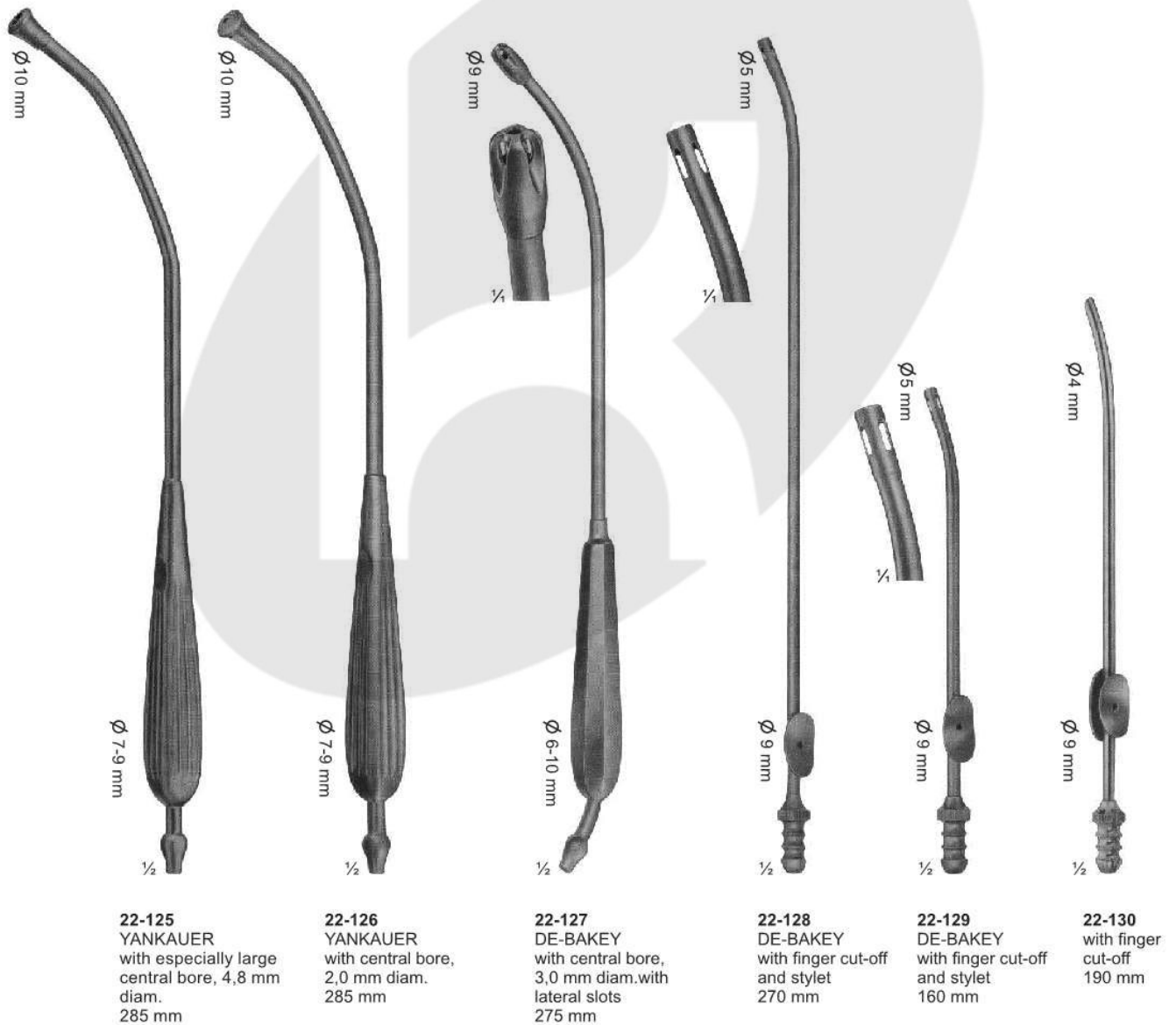

Suction Instruments

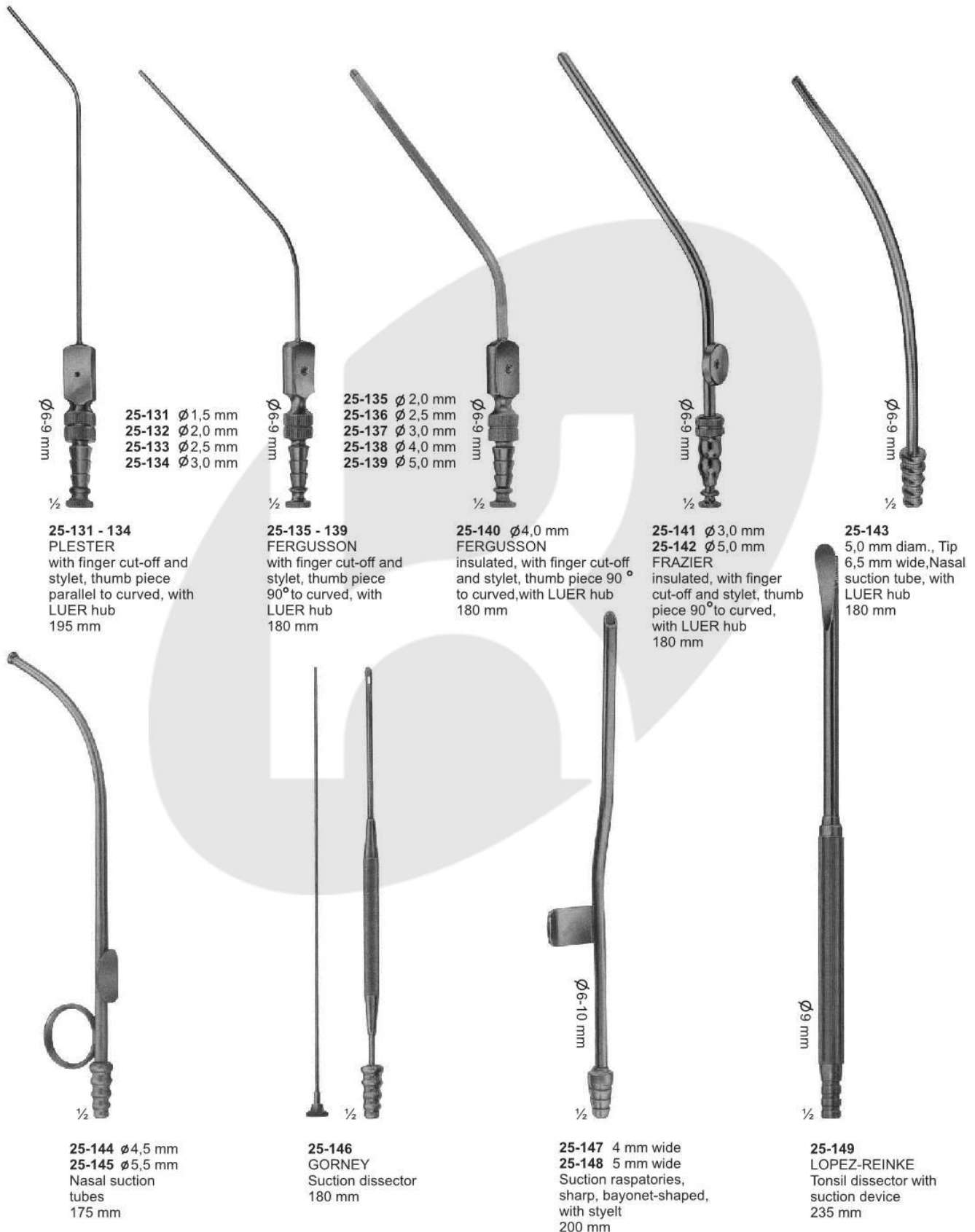

Suction Instruments

25-150
WULLSTEIN
Suction tube, conical, silver, oliver
with LUER hub
160 mm

$\varnothing 1,75$ mm

$\varnothing 3$ mm
 $\frac{1}{2}$
 $\varnothing 8$ mm

25-151 1,5 mm
25-152 2,0 mm
WULLSTEIN
Suction tube, cylindrical, silver, with
stylet with LUER hub
160 mm

$\frac{1}{2}$
 $\varnothing 8$ mm

Usable length

YASARGIL usable length diam.		YASARGIL usable length diam.	
25-153	130 mm 1,5 mm	25-161	130 mm 2,5 mm
25-154	150 mm 1,5 mm	25-162	150 mm 2,5 mm
25-155	180 mm 1,5 mm	25-163	180 mm 2,5 mm
25-156	220 mm 1,5 mm	25-164	220 mm 2,5 mm
25-157	130 mm 2,0 mm	25-165	130 mm 3,5 mm
25-158	150 mm 2,0 mm	25-166	150 mm 3,5 mm
25-159	180 mm 2,0 mm	25-167	180 mm 3,5 mm
25-160	220 mm 2,0 mm	25-168	220 mm 3,5 mm
		25-169	180 mm 4,5 mm

$\varnothing 6,5-9$ mm
with LUER hub

25-170 - 172
LANDOLT
150 MM
diam $\varnothing 3$ mm

25-170 8 mm / curved
25-171 11mm / curved
25-172 15mm / curved

$\frac{1}{2}$

$\varnothing 3,5$ mm

$\varnothing 2,0$ mm

25-173 500 mm
25-174 350 mm
with rubber tip,
with LUER hub

$\varnothing 9$ mm
 $\frac{1}{2}$

25-175 2,0 mm diam
25-176 2,5 mm diam
25-177 3,0 mm diam
with finger cut-off,
thumb piece 90° to
curved, with LUER hub
250 mm

$\varnothing 6-9$ mm
 $\frac{1}{2}$

Combined Suction and Irrigation Cannulae

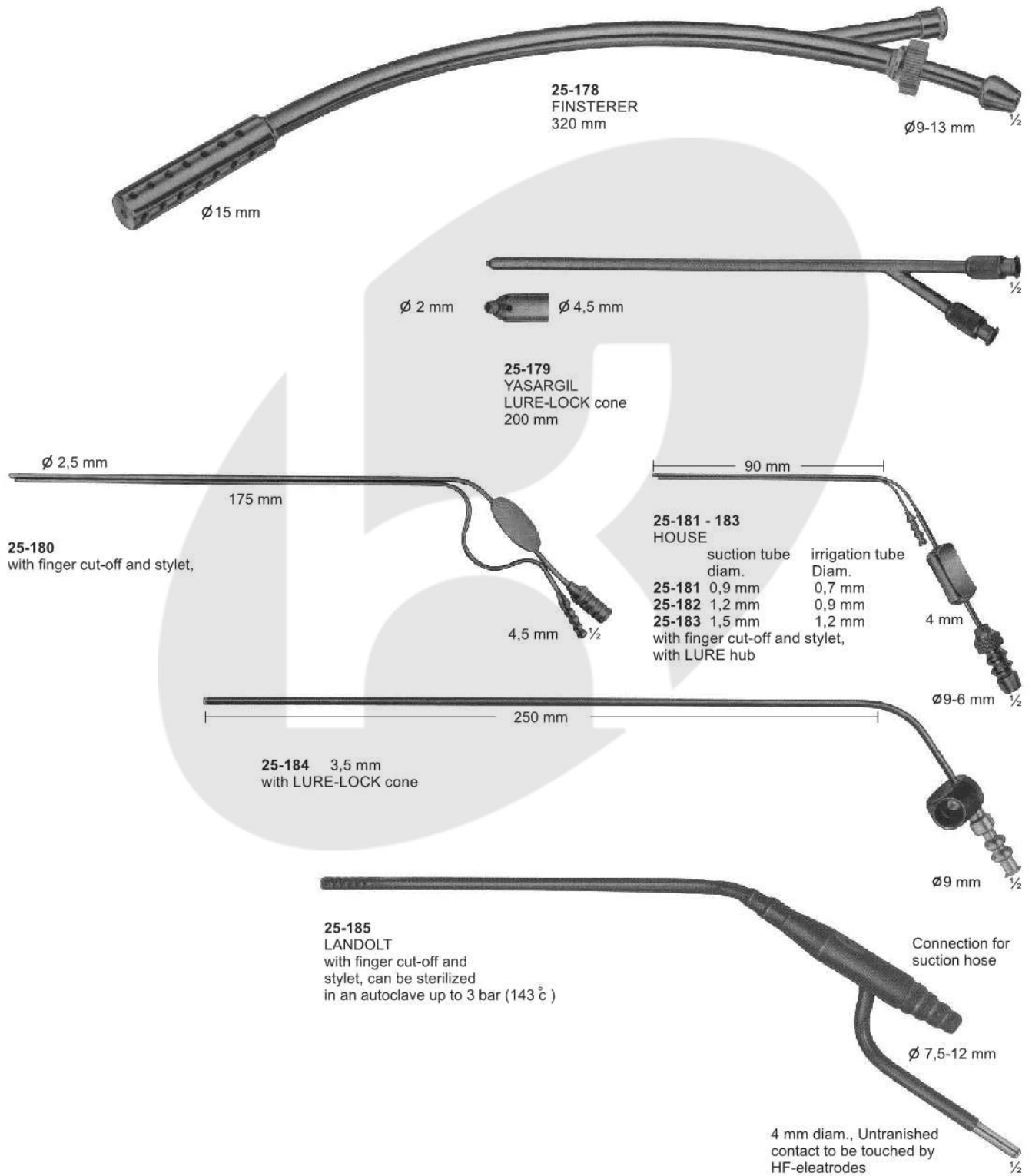

Scissors with Tungsten Carbide Inserts



26-101
Standard

14,5cm
16,5cm
18,5cm



26-102
Standard

14,5cm
16,5cm
18,5cm



26-103
Standard

14,5cm
16,5cm
18,5cm



26-104
Standard

14,5cm
16,5cm
18,5cm



26-105
Standard

14,5cm
16,5cm
18,5cm



26-106
Standard

14,5cm
16,5cm
18,5cm

Scissors with Tungsten Carbide Inserts

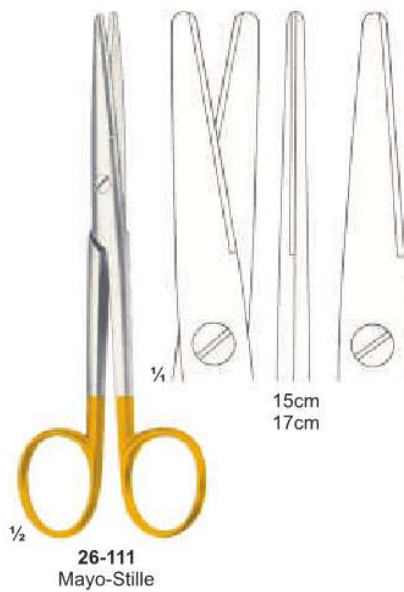

Scissors with Tungsten Carbide Inserts



Scissors with Tungsten Carbide Inserts

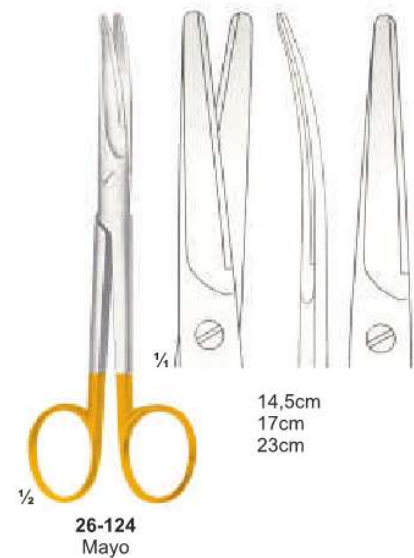

Scissors with Tungsten Carbide Inserts

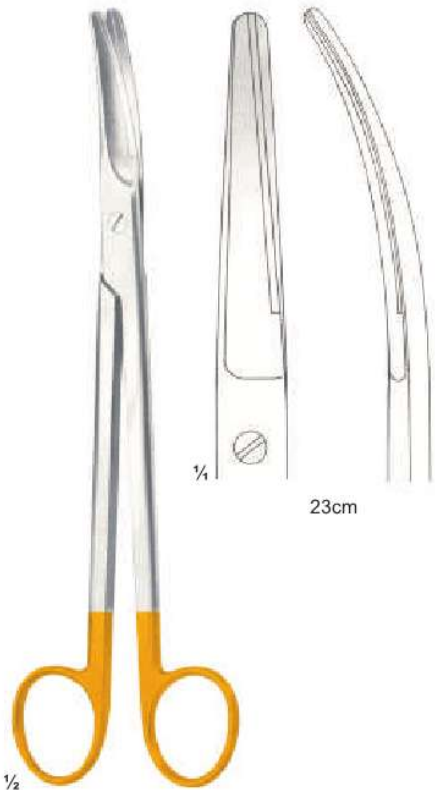

26-125
Parametrium

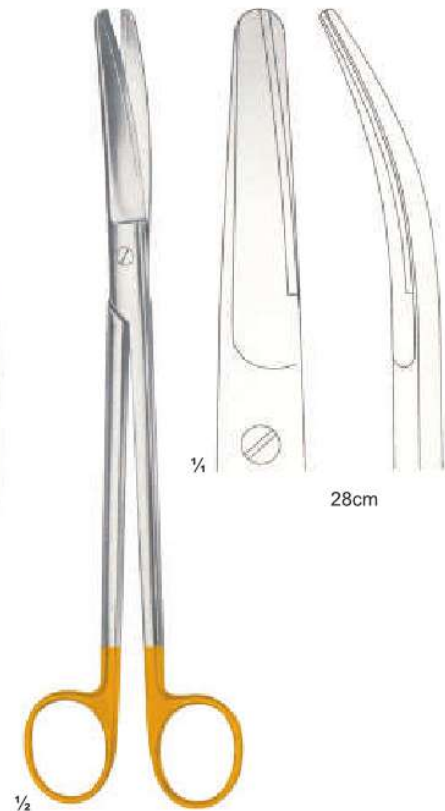

26-126
Mayo-Harrington

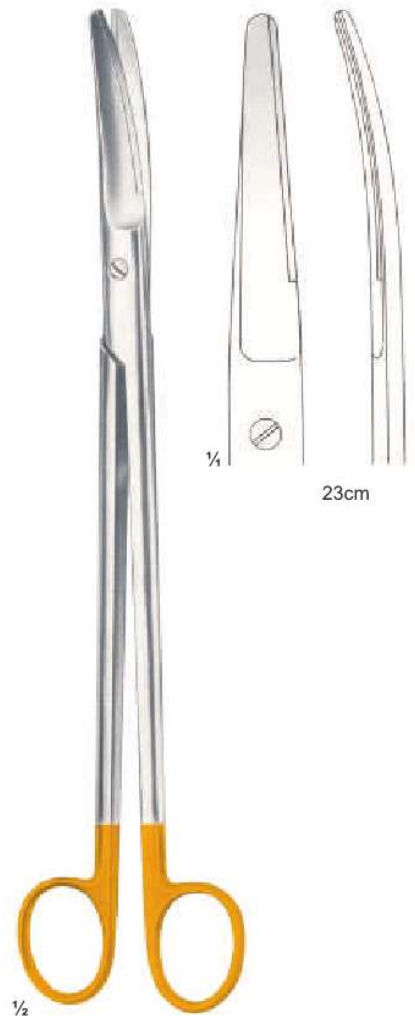

26-127
Sims

Scissors with Tungsten Carbide Inserts

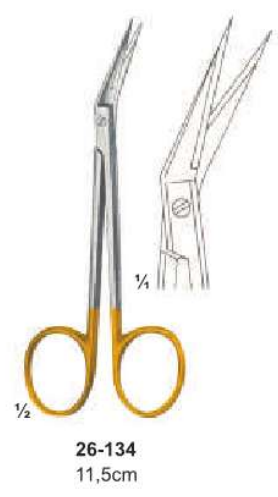
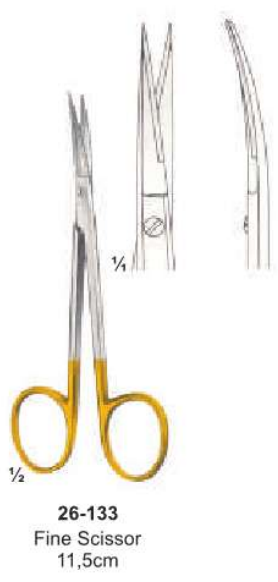
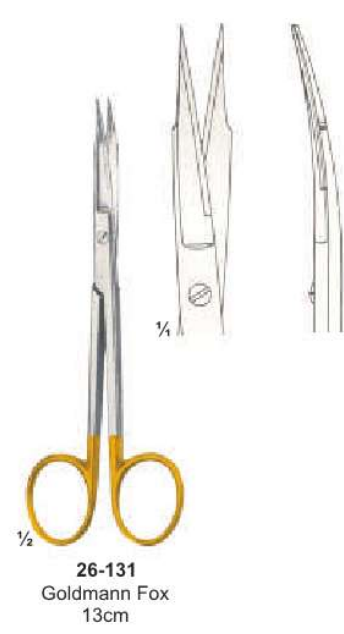

Scissors & Dissecting Forceps with Tungsten Carbide Inserts

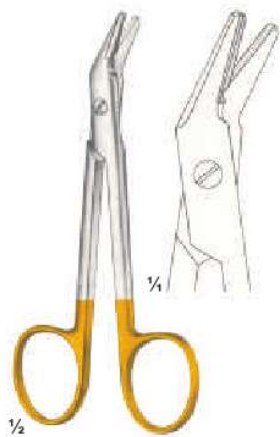

26-136
Universal
12cm



26-137
Ligature Scissors
1 Black & 1 Goldplated ring



26-138
Adson



26-139
Cushing
17,5cm



26-140
Cushing
18cm



26-141
Cushing-Taylor
18cm



26-142
Dissecting Forceps
15cm



26-143
Semken
15cm

Dissecting Forceps and Needle holders with Tungsten Carbide Inserts

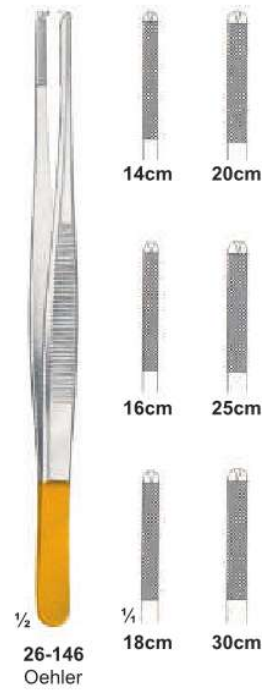
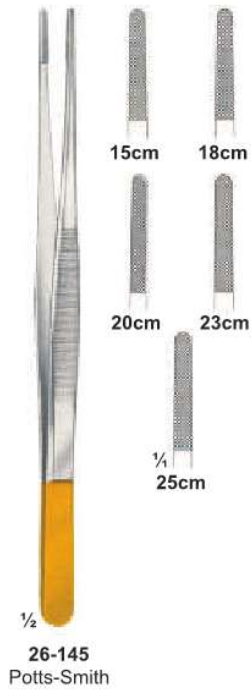

Needle holders with Tungsten Carbide Inserts



Needle holders with Tungsten Carbide Inserts



26-159
Bozemann-Wertheim
20cm 24cm 26cm

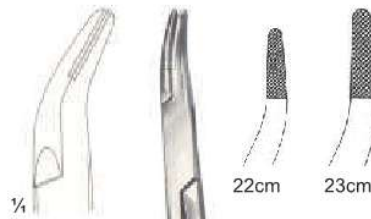

26-160
Stratte
22cm 23cm



26-161
Ryder
13cm 15cm 18cm
20cm 23cm 26cm



26-162
Ryder-Vascular
13cm 15cm 18cm
20cm 23cm 26cm



26-163
Martin
15cm 17cm 20cm



26-164
Sarot
18cm 20cm 26cm

Needle holders with Tungsten Carbide Inserts



Needle holders with Tungsten Carbide Inserts

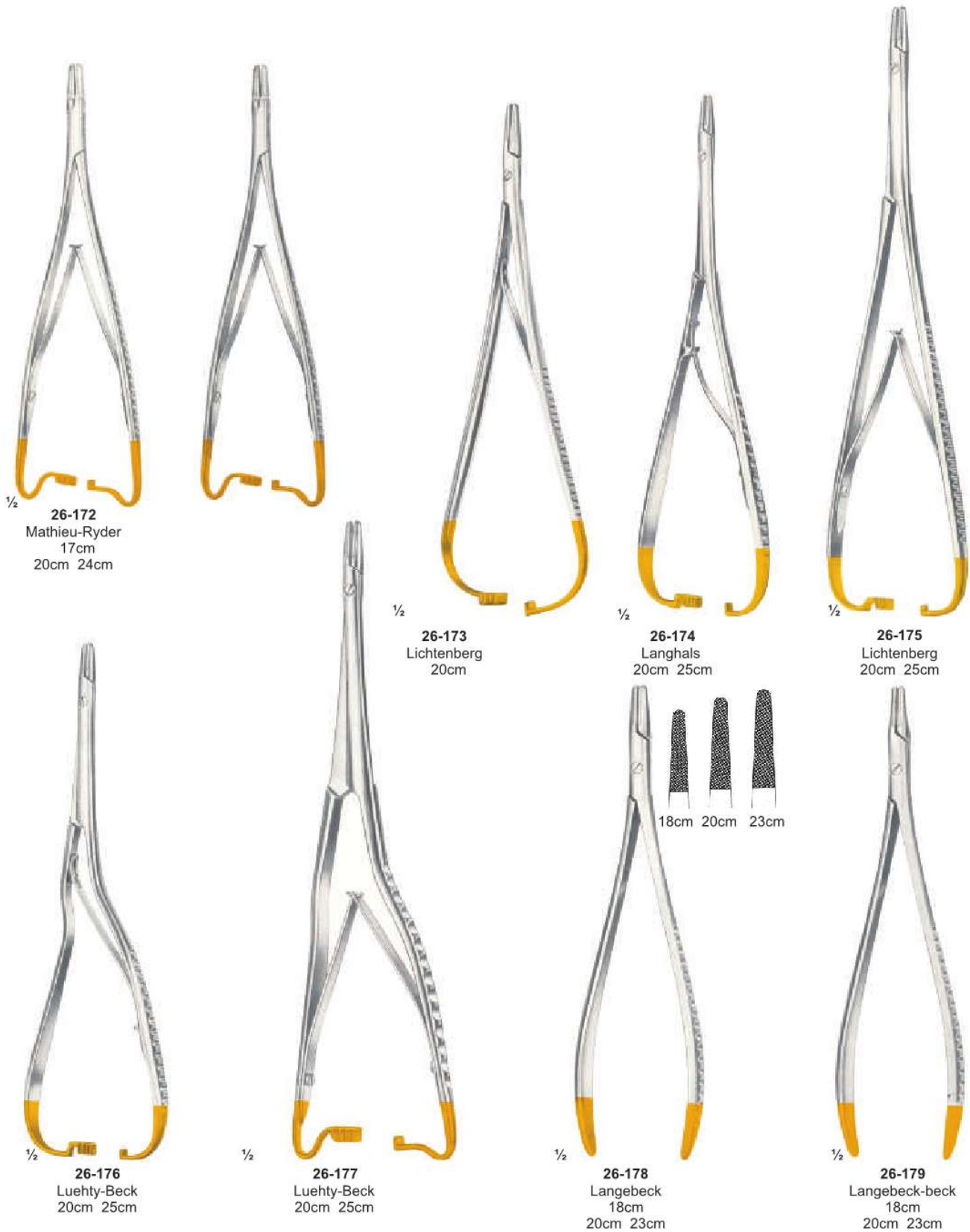

Hospital Wares

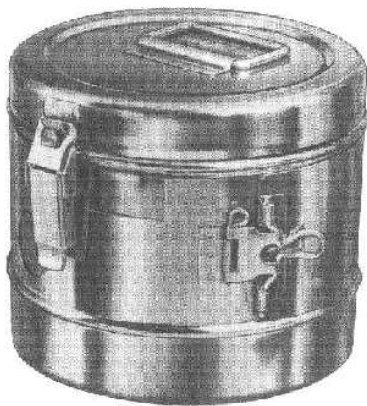

27-101 - 115
Schimmelbusch

	Ø x H sizes in mm
27-101	80 x 80
27-102	105 x 120
27-103	140 x 140
27-104	160 x 120
27-105	160 x 150
27-106	190 x 150
27-107	190 x 190
27-108	240 x 160
27-109	240 x 240
27-110	290 x 160
27-111	290 x 240
27-112	340 x 160
27-113	340 x 340
27-114	390 x 190
27-115	390 x 290

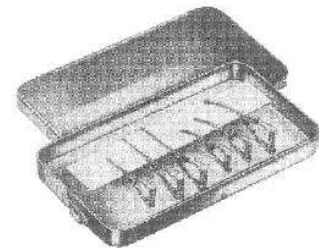

27-116
Box
120 x 65 x 13mm
(without Bulldog clamps,
without silicone tape)



27-117
Box with support
120 x 65 x 13 mm
(ohne Bulldogklemmen)



27-118
Box with support for
needle electrodes,
without instruments

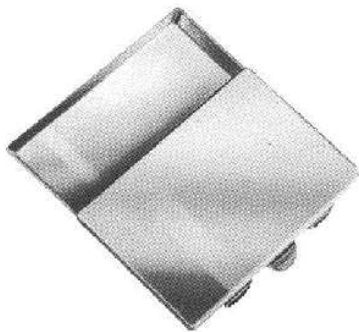

27-119 - 121
50 x 25 x 4,5 mm
27-120
65 x 42 x 8 mm
27-121
75 x 25 x 4,5 mm

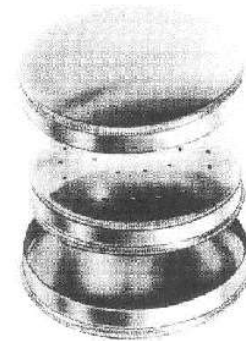

27-122
Ø 65mm x 15mm

Hospital Wares

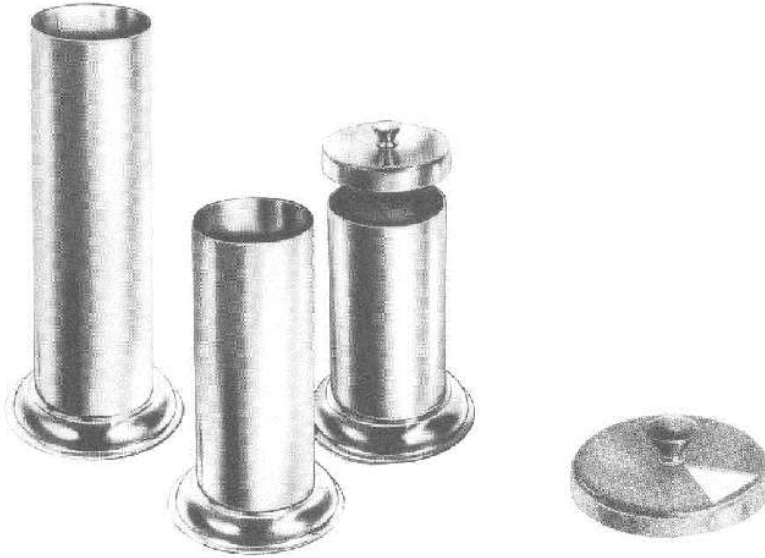

27-123 - 131

	Ø x H
27-123	30 x 90 mm
27-124	50 x 100 mm
27-125	50 x 130 mm
27-126	50 x 175 mm
27-127	75 x 100 mm
27-128	75 x 130 mm
27-129	75 x 175 mm
27-130	100 x 175 mm
27-131	100 x 200 mm



27-132 - 139

27-132	165 x 85 x 35 mm
27-133	200 x 100 x 35 mm
27-134	200 x 100 x 50 mm
27-135	230 x 130 x 50 mm
27-136	260 x 150 x 50 mm
27-137	270 x 235 x 50 mm
27-138	300 x 200 x 50 mm
27-139	325 x 275 x 50 mm

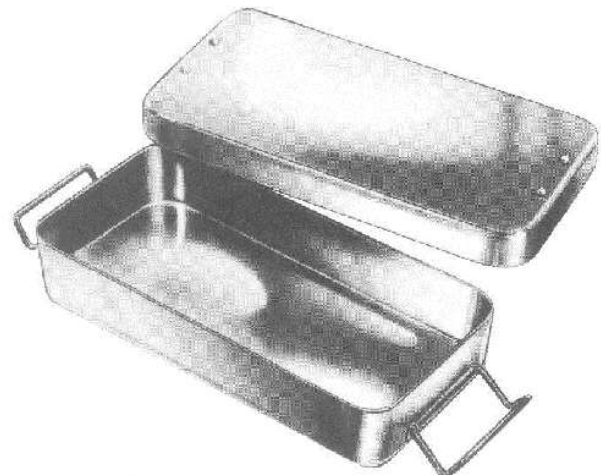

27-140
205 x 105 x 35 mm

Forceps Jars

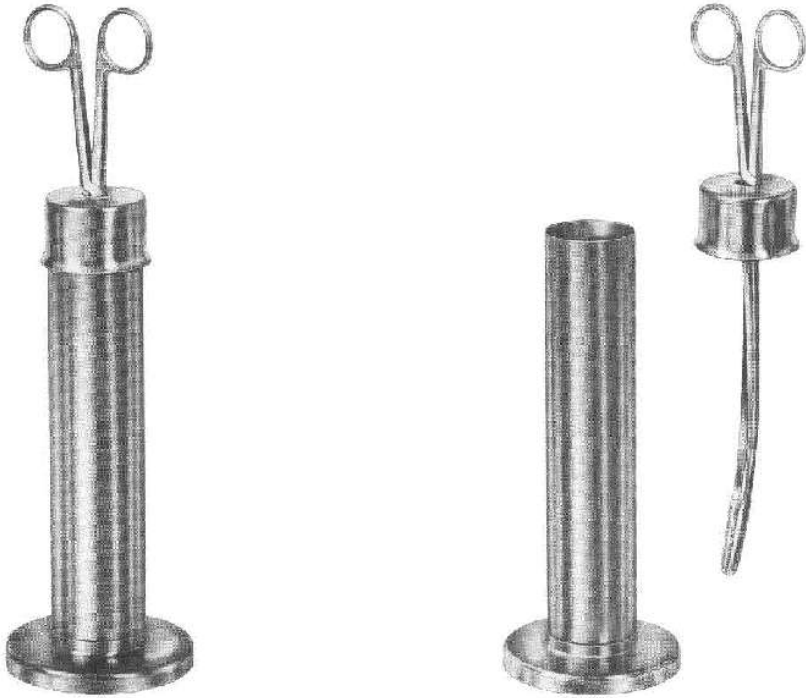

27-141 - 142

- 27-141** Martin Sterilizing Forceps consisting of:
 - 1 Sterilizing Forceps, curved, 25 cm, without ratchet, with lid for jar
 - 1 jar with bottom plate (anti-tilt)
- 27-142** ditto, with 32 cm long Sterilizing Forceps

Round Metal Boxes and Medicine Cups

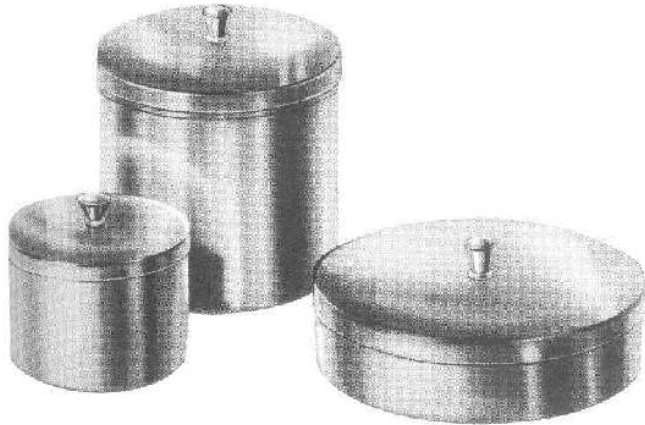

27-143 - 148

	Ø x H
27-143	75 x 60 mm
27-144	75 x 75 mm
27-145	100 x 60 mm
27-146	100 x 100 mm
27-146A	125 x 80 mm
27-147	125 x 125 mm
27-148	150 x 150 mm

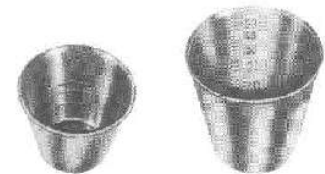

27-149
25 cc

27-150
50 cc



27-151
20 cc
Medicine Spoon

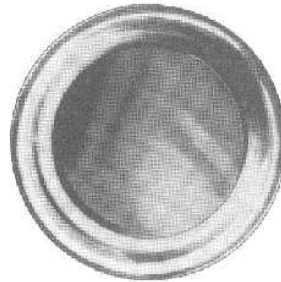

27-152
Ø 75 x 12 mm
Tablet Tray



27-153
Ø 90 x 90 mm
Metal Cup



27-154
Ø 75 x 80 mm
Sputum Cup

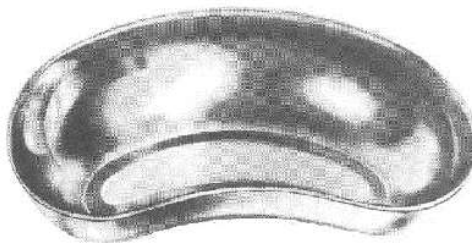

Kidney Dish

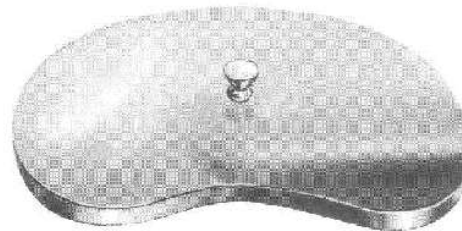

27-155 - 157

27-155	170 x 100 x 35 mm
27-156	250 x 140 x 40 mm
27-157	275 x 150 x 45 mm

Hospital Wares



27-158 - 165

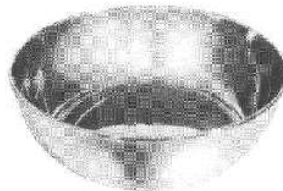

27-166 - 170

	Ø x H		
27-158	40 x 19 mm	0.05L	
27-159	61 x 30 mm	0.07L	
27-160	80 x 40 mm	0.14L	
27-161	116 x 50 mm	0.35L	
27-162	128 x 55 mm	0.45L	
27-163	147 x 65 mm	0.70L	
27-164	167 x 75 mm	1.10L	
27-165	187 x 85 mm	1.60L	

27-166	116 x 35 mm	0.30L
27-167	128 x 38 mm	0.40L
27-168	147 x 40 mm	0.50L
27-169	157 x 45 mm	0.75L
27-170	187 x 45 mm	1.00L

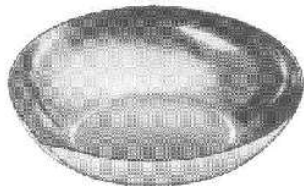

27-171
Ø 110 x 28 mm 0.15L



27-172
100 cc 0.1L



27-173 - 176
27-173 0.25L
27-174 0.50L
27-175 1.00L
27-176 2.00L



27-177
235 x 190 x 40 mm



27-178
Ø 220 x 70 mm

Hospital Wares



27-179
Ø 50 x 100 mm
Powder Pot



27-180
Ø 50 x 75 mm
Methot With Lid



27-181
Ø 50 x 75 mm
Methot Without Lid

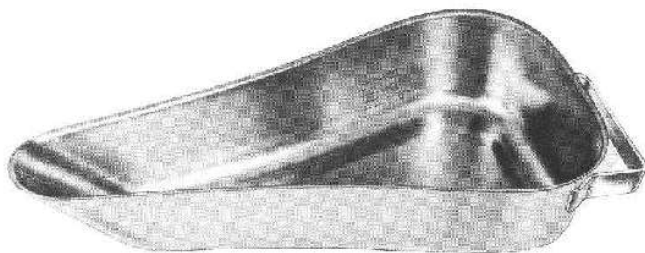

27-182

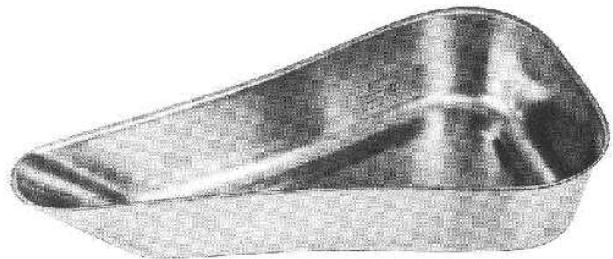

27-183

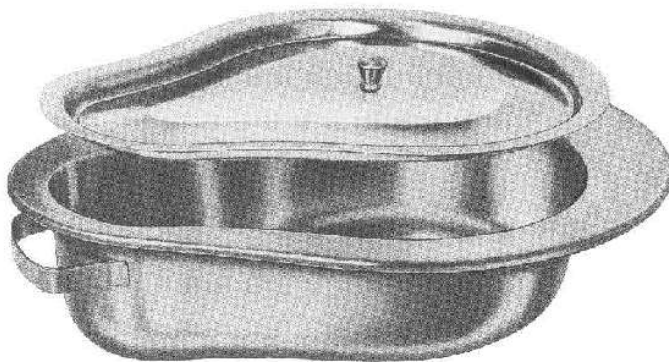

27-184

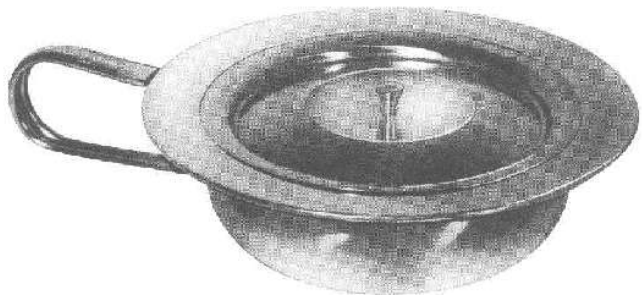

27-185 - 186

27-185 Ø 235 mm
27-186 Ø 310 mm

Needle Cases

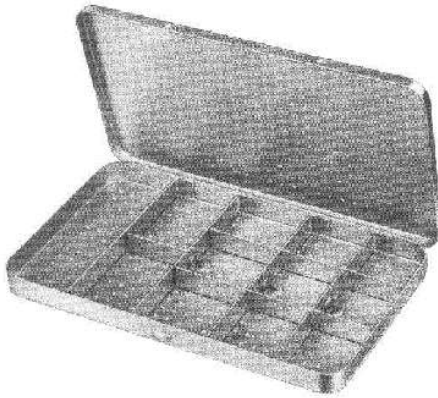

27-187
Sauerbruch
210 x 125 x 17 mm



27-188
Sauerbruch
210 x 125 x 17 mm



27-189
150 x 95 x 13 mm



27-190
150 x 95 x 13 mm



27-191
150 x 95 x 13 mm



27-192
150 x 95 x 13 mm

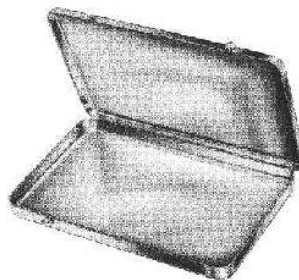

27-193
150 x 95 x 13 mm

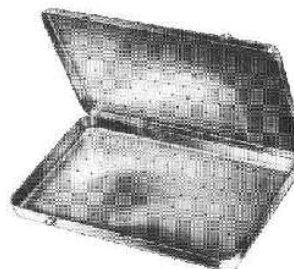

27-194
150 x 95 x 13 mm

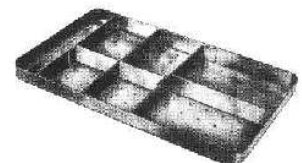

27-195
150 x 95 x 11 mm

Storing Cases

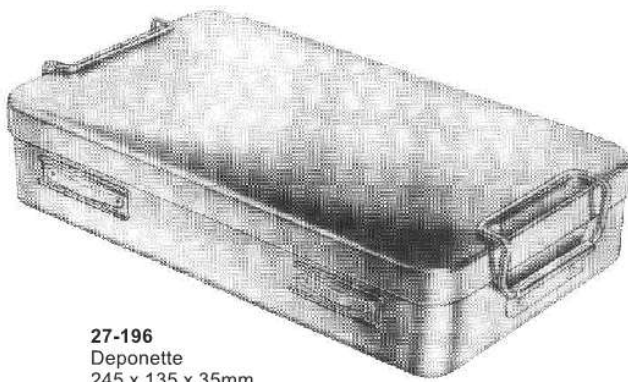

27-196
Deponette
245 x 135 x 35mm

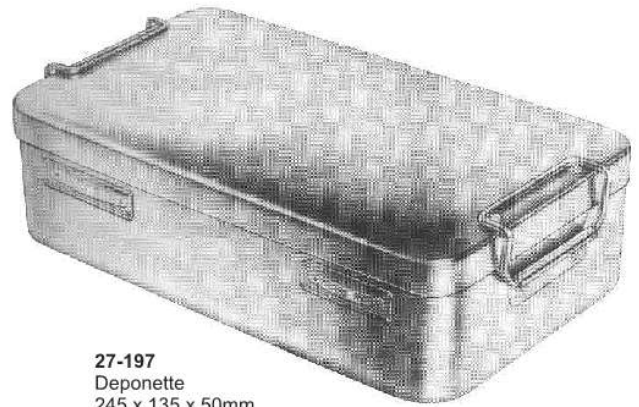

27-197
Deponette
245 x 135 x 50mm

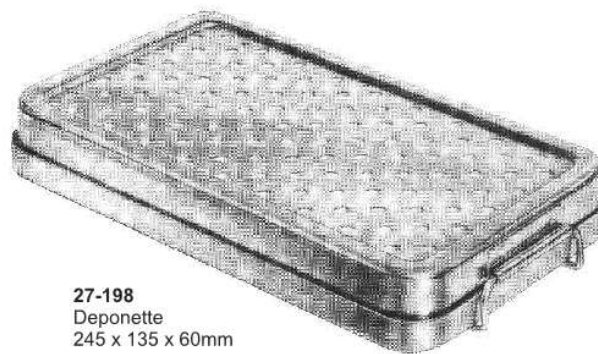

27-198
Deponette
245 x 135 x 60mm

Storing Cases

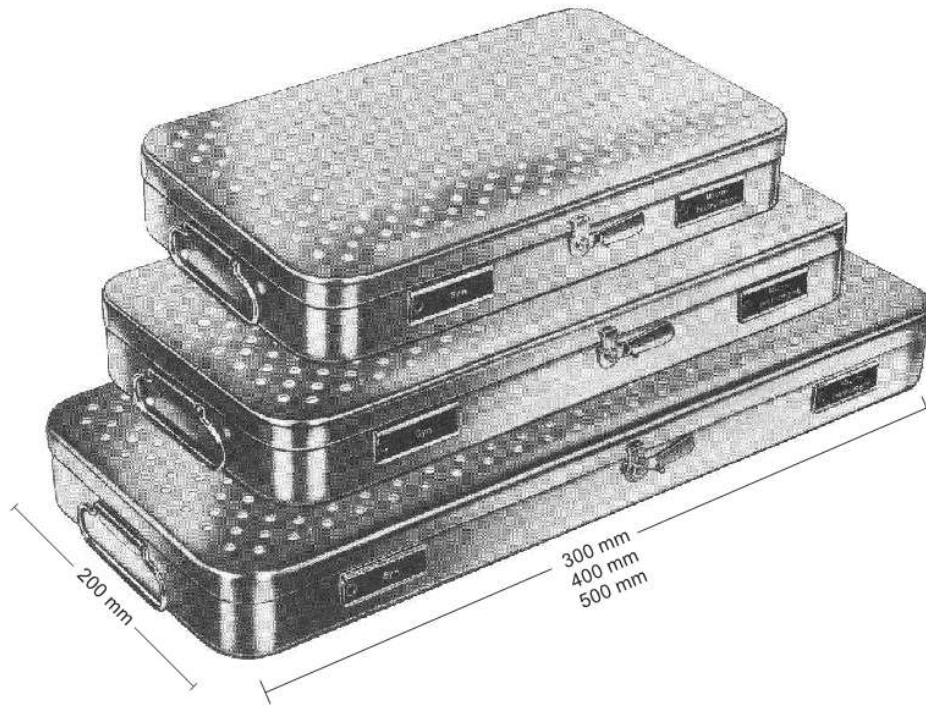

27-199 - 209

27-199	230 x 130 x 50	mm
27-200	260 x 150 x 50	mm
27-201	275 x 235 x 50	mm
27-202	300 x 200 x 50	mm
27-203	325 x 275 x 50	mm
27-204	420 x 175 x 50	mm
27-205	230 x 130 x 75	mm
27-206	260 x 150 x 75	mm
27-207	300 x 200 x 75	mm
27-208	325 x 275 x 75	mm
27-209	420 x 175 x 75	mm

Sterilizing Baskets / Trays

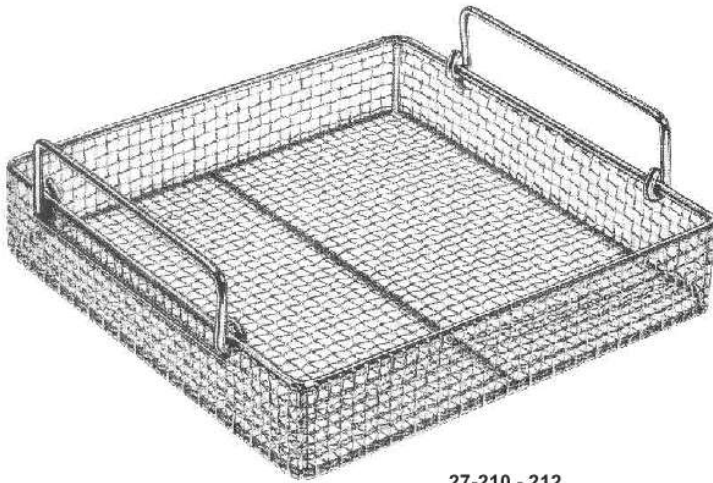

27-210 - 212

27-210	480 x 250 x 50	mm
27-211	520 x 250 x 75	mm
27-212	520 x 250 x 100	mm



27-213 - 218

27-213	240 x 240 x 50	mm
27-214	240 x 240 x 80	mm
27-215	240 x 240 x 100	mm
27-216	480 x 260 x 50	mm
27-217	520 x 260 x 80	mm
27-218	520 x 260 x 100	mm



The manufacturing of surgical instruments has a long tradition at Kadimson International - keeping in mind that Kadimson International was and is pure instrument manufacturer at the time when the company was founded. Our claim has remained unchanged to the present day to manufacture instruments of the highest quality.



www.kadimson.com

Contact Us

-  Kadimson International Jurian Road, Bhagwal Awan, Sialkot - 51310 Pakistan
-  info@kadimson.com / kadimson@outlook.com
-  +92-307-3225547